

勝特力電材超市-龍山店 886-3-5773766
 勝特力電材超市-光復店 886-3-5729570
 勝特力電子(上海) 86-21-34970699
 勝特力電子(深圳) 86-755-83298787
<http://www.100y.com.tw>



40x40x28 mm

San Ace 40 9GA type Low Power Consumption Fan

General Specifications

- Material Frame: Plastic (Flammability: UL 94V-0), Impeller: Plastic (Flammability: UL 94V-0)
- Expected life See the table below. (L10 life: 90% survival rate for continuous operation in free air at 60°C, rated voltage)
- Motor protection function Locked rotor burnout protection, Reverse polarity protection
For details, please refer to p. 547.
- Dielectric strength 50/60 Hz, 500 VAC, for 1 minute (between lead wire conductors and frame)
- Insulation resistance 10 MΩ or more with a 500 VDC megger (between lead wire conductors and frame)
- Sound pressure level (SPL) At 1 m away from the air inlet
- Storage temperature -30 to +70°C (Non-condensing)
- Lead wire ⊕Red ⊖Black (Sensor) Yellow (Control) Brown
- Mass 53 g

Specifications

The models listed below **have ribs and pulse sensors with PWM control function.** For models without ribs, append "1" to the end of model numbers.

Model no.	Rated voltage [V]	Operating voltage range [V]	PWM duty cycle* [%]	Rated current [A]	Rated input [W]	Rated speed [min ⁻¹]	Max. airflow [m ³ /min] [CFM]	Max. static pressure [Pa] [inchH ₂ O]	SPL [dB (A)]	Operating temperature [°C]	Expected life [h]				
9GA0412P3K01	12	10.8 to 13.2	100	0.92	11.04	22000	0.81 28.6	799 3.21	61	-20 to +60	30000/60°C				
			0	0.1	1.2	6500	0.23 8.12	68 0.27	32						
9GA0412P3J01			100	0.49	5.88	18000	0.67 23.7	535 2.15	54			-20 to +70	40000/60°C		
			0	0.05	0.6	4500	0.16 5.7	33 0.13	22						
9GA0412P3G01			100	0.39	4.68	16500	0.61 21.5	450 1.81	53						
			0	0.05	0.6	4500	0.16 5.7	33 0.13	22						
9GA0412P3H01			100	0.28	3.36	14500	0.54 19.1	347 1.39	50						
			0	0.04	0.48	3500	0.13 4.6	20 0.08	17						
9GA0412P3M01			100	0.21	2.52	12500	0.46 16.2	258 1.04	47						
			0	0.04	0.48	3500	0.13 4.6	20 0.08	17						
9GA0424P3J001**			24	21.6 to 26.4	100	0.27	6.48	18000	0.67 23.7	535 2.15	54				
9GA0424P3G001**					100	0.22	5.28	16500	0.61 21.5	450 1.81	53				
9GA0424P3H001**	100	0.16			3.84	14500	0.54 19.1	347 1.39	50						
9GA0424P3M001**	100	0.11			2.64	12500	0.46 16.2	258 1.04	47						

* PWM frequency: 25 kHz ** Fan does not rotate when PWM duty cycle is 0%.

The following sensor and control options are available for selection.

Available for all models. Without sensor Pulse sensor

Differs according to the model. Refer to the table on p. 570. Lock sensor

Airflow - Static Pressure Characteristics / PWM Duty - Speed Characteristics Example

9GA0412P3K01 With pulse sensor with PWM control function

PWM duty cycle

Operating voltage range

PWM duty - Speed characteristics example

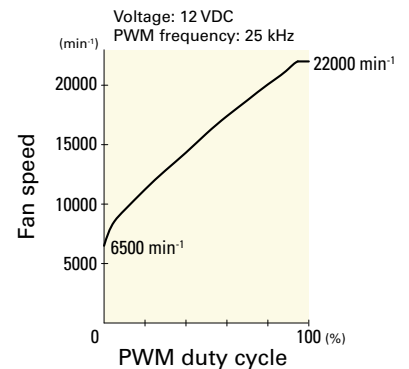
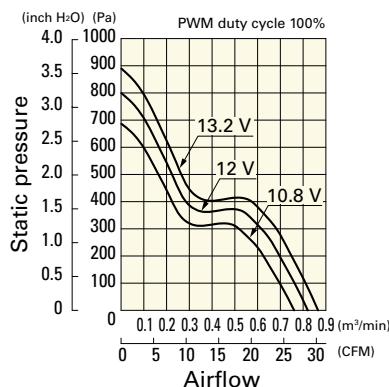
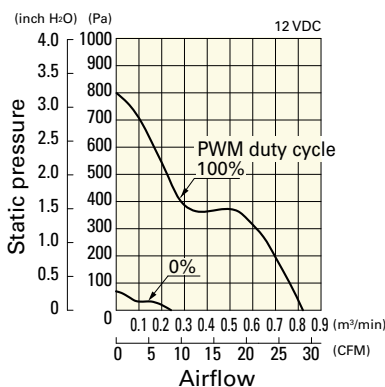

Airflow - Static Pressure Characteristics / PWM Duty - Speed Characteristics Example

DC

DC Fan 40 mm sq.

9GA0412P3J01 With pulse sensor with PWM control function

PWM duty cycle



Operating voltage range



PWM duty - Speed characteristics example



9GA0412P3G01 With pulse sensor with PWM control function

PWM duty cycle



Operating voltage range



PWM duty - Speed characteristics example

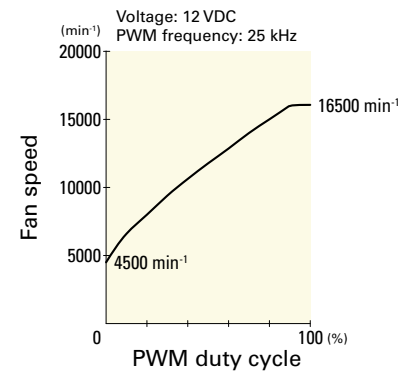

9GA0412P3H01 With pulse sensor with PWM control function

PWM duty cycle



Operating voltage range



PWM duty - Speed characteristics example

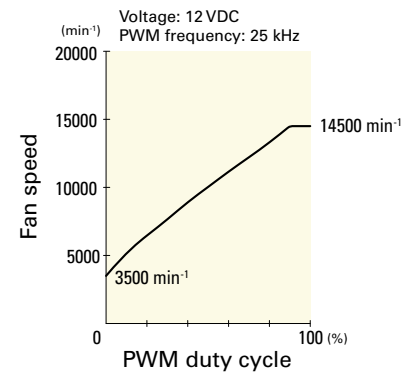

9GA0412P3M01 With pulse sensor with PWM control function

PWM duty cycle

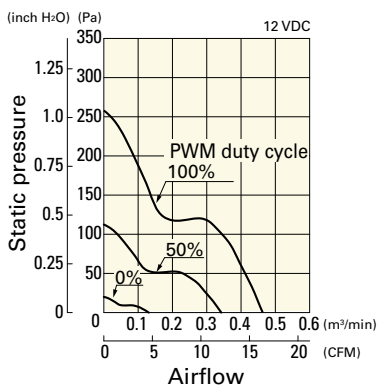

Operating voltage range

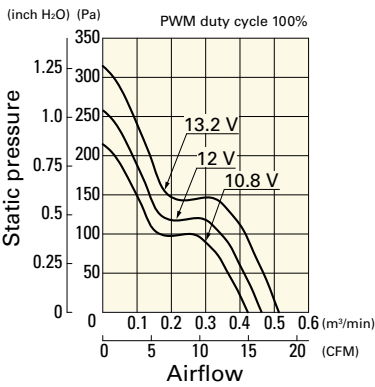

PWM duty - Speed characteristics example

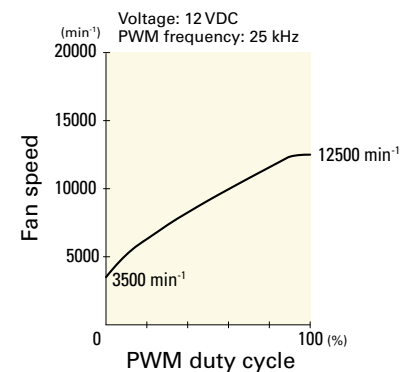

Airflow - Static Pressure Characteristics / PWM Duty - Speed Characteristics Example

9GA0424P3J001 With pulse sensor with PWM control function

PWM duty cycle



Operating voltage range



PWM duty - Speed characteristics example

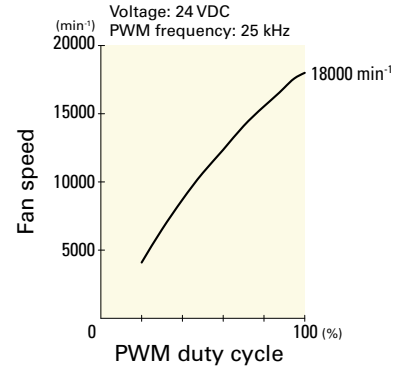

9GA0424P3G001 With pulse sensor with PWM control function

PWM duty cycle



Operating voltage range



PWM duty - Speed characteristics example

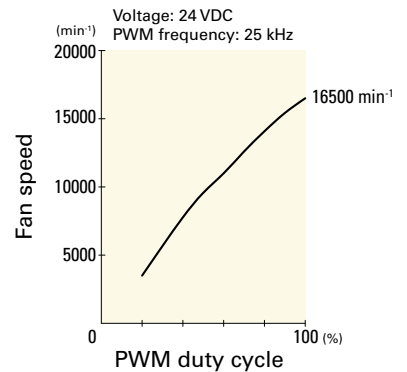

9GA0424P3H001 With pulse sensor with PWM control function

PWM duty cycle

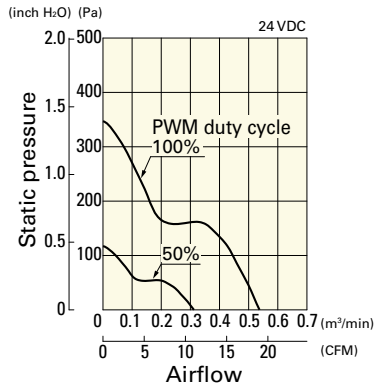

Operating voltage range

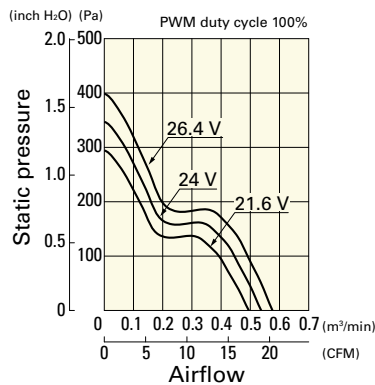

PWM duty - Speed characteristics example

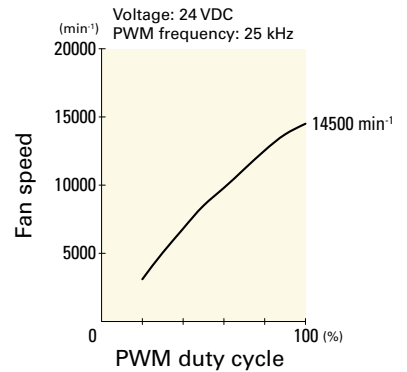

9GA0424P3M001 With pulse sensor with PWM control function

PWM duty cycle



Operating voltage range



PWM duty - Speed characteristics example

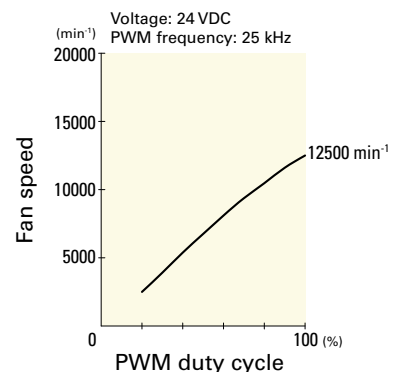

勝特力電材超市-龍山店 886-3-5773766
 勝特力電材超市-光復店 886-3-5729570
 勝特力電子(上海) 86-21-34970699
 勝特力電子(深圳) 86-755-83298787
<http://www.100y.com.tw>

DC
DC Fan 40 mm sq.

Dimensions (unit: mm) (With ribs)

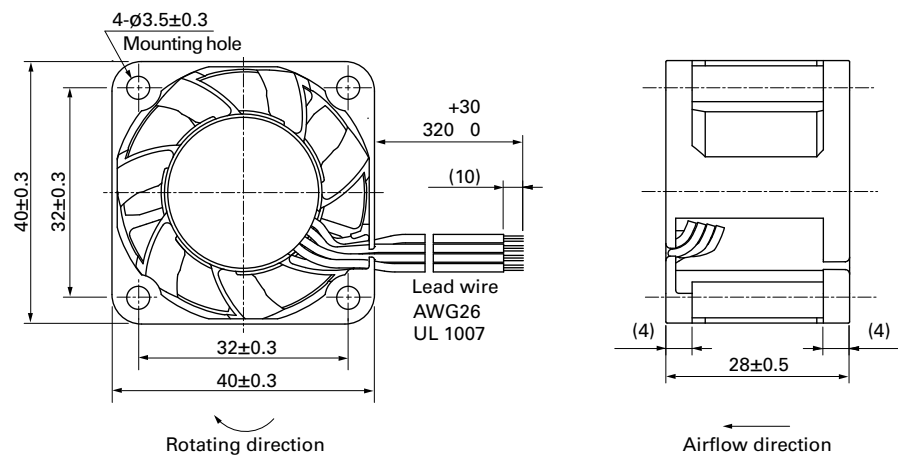

Reference Dimensions of Mounting Holes and Vent Opening (unit: mm)

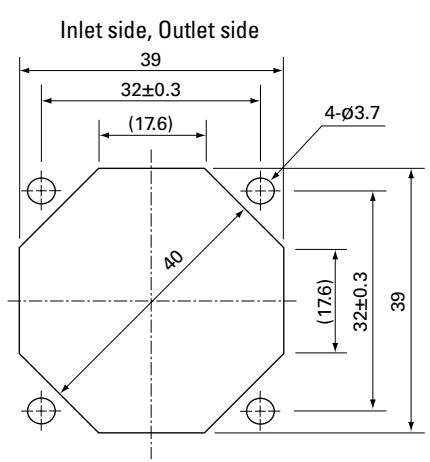

Options

Finger guards page: p. 532

Model no.: 109-059, 109-059H

Mouser Electronics

勝特力電材超市-龍山店 886-3-5773766
勝特力電材超市-光復店 886-3-5729570
勝特力电子(上海) 86-21-34970699
勝特力电子(深圳) 86-755-83298787
<http://www.100y.com.tw>

Authorized Distributor

Click to View Pricing, Inventory, Delivery & Lifecycle Information:

Sanyo Denki:

[9GA0412P3J011](#) [9GA0424P3H001](#) [9GA0424P3J001](#) [9GA0424P3J0011](#) [9GA0424P3M0011](#) [9GA0424P3M001](#)
[9GA0424P3H0011](#) [9GA0424P3G0011](#) [9GA0424P3G001](#) [9GA0412P3G01](#) [9GA0412P3G011](#) [9GA0412P3H01](#)
[9GA0412P3H011](#) [9GA0412P3J01](#) [9GA0412P3M01](#) [9GA0412P3M011](#) [9GA0412P3K01](#) [9GA0412P3K011](#)
[9GA0412J301](#) [9GA0412M301](#) [9GA0424G3001](#) [9GA0412G301](#) [9GA0424J30011](#) [9GA0412H301](#) [9GA0424M30011](#)
[9GA0424J3001](#) [9GA0412G3011](#) [9GA0424G30011](#) [9GA0424M3001](#) [9GA0412M3011](#) [9GA0412K3011](#)
[9GA0424H30011](#) [9GA0412H3011](#) [9GA0424H3001](#) [9GA0412J3011](#) [9GA0412K301](#) [9GA0412J302](#) [9GA0412J3021](#)
[9GA0412J3D01](#) [9GA0412G302](#) [9GA0412G3021](#) [9GA0412H302](#) [9GA0424H3002](#) [9GA0424H30021](#)
[9GA0424H3D001](#) [9GA0412M302](#) [9GA0412M3021](#) [9GA0412M3D01](#) [9GA0424G3002](#) [9GA0424G30021](#)
[9GA0424G3D001](#) [9GA0424M3002](#) [9GA0424M30021](#) [9GA0424M3D001](#) [9GA0412K302](#) [9GA0412K3021](#)
[9GA0412K3D01](#) [9GA0412H3021](#) [9GA0412H3D01](#) [9GA0412H3D011](#) [9GA0424J3002](#) [9GA0424J30021](#)
[9GA0424J3D001](#)