

勝特力電材超市-龍山店 886-3-5773766  
 勝特力電材超市-光復店 886-3-5729570  
 勝特力电子(上海) 86-21-34970699  
 勝特力电子(深圳) 86-755-83298787  
<http://www.100y.com.tw>



# 92x92x25 mm

San Ace 92T 9GT type

## General Specifications

- Material ..... Frame: Aluminum, Impeller: Plastic (Flammability: UL 94V-1)
- Expected life ..... See the table below. (L10 life: 90% survival rate for continuous operation in free air at 85°C, rated voltage)
- Motor protection function ..... Locked rotor burnout protection, Reverse polarity protection  
For details, please refer to p. 547.
- Dielectric strength ..... 50/60 Hz, 500 VAC, for 1 minute (between lead wire conductors and frame)
- Insulation resistance ..... 10 MΩ or more with a 500 VDC megger (between lead wire conductors and frame)
- Sound pressure level (SPL) ..... At 1 m away from the air inlet
- Storage temperature ..... -40 to +85°C (Non-condensing)
- Lead wire ..... ⊕Red ⊖Black (Sensor) Yellow (Control) Brown
- Mass ..... 150 g

## Specifications

The models listed below **have pulse sensors with PWM control function.**

Model no.	Rated voltage [V]	Operating voltage range [V]	PWM duty cycle* [%]	Rated current [A]	Rated input [W]	Rated speed [min <sup>-1</sup> ]	Max. airflow [m <sup>3</sup> /min] [CFM]	Max. static pressure [Pa] [inchH <sub>2</sub> O]	SPL [dB (A)]	Operating temperature [°C]	Expected life [h]
9GT0912P4J001	12	10.2 to 13.8	100	0.42	5.04	5000	2.2 77.7	105 0.42	44	-40 to +85	40000/85°C
			30	0.07	0.84	1850	0.81 28.7	14.3 0.05	18		
9GT0924P4J001	24	20.4 to 27.6	100	0.21	5.04	5000	2.2 77.7	105 0.42	44		
			30	0.05	1.2	1850	0.81 28.7	14.3 0.05	18		

\* PWM frequency: 25 kHz. Fan does not rotate when PWM duty cycle is 0%.

The following sensor and control options are available for selection.

Available for all models. Without sensor Pulse sensor

Differs according to the model. Refer to the table on p. 573. Lock sensor

## Airflow - Static Pressure Characteristics / PWM Duty - Speed Characteristics Example

**9GT0912P4J001** With pulse sensor with PWM control function

PWM duty cycle

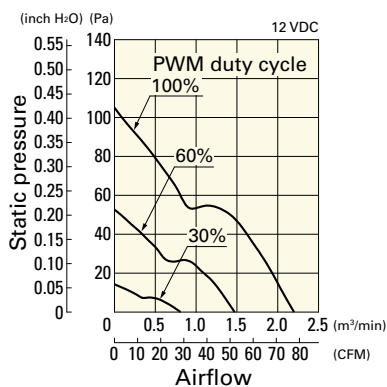

Operating voltage range

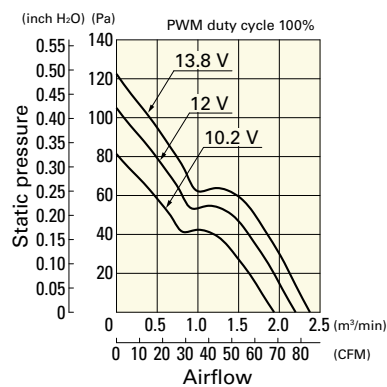

PWM duty - Speed characteristics example

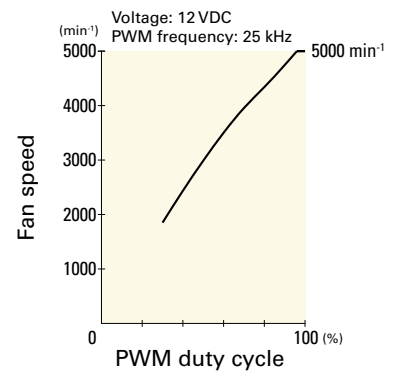

## Airflow - Static Pressure Characteristics / PWM Duty - Speed Characteristics Example

9GT0924P4J001 With pulse sensor with PWM control function

PWM duty cycle

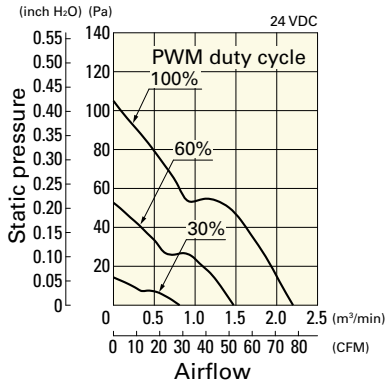

Operating voltage range

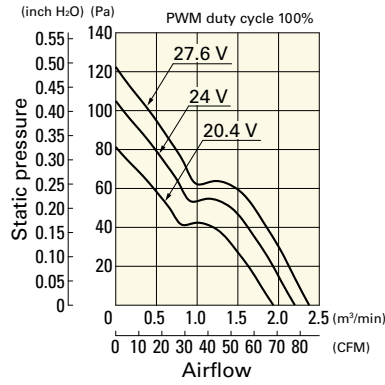

PWM duty - Speed characteristics example

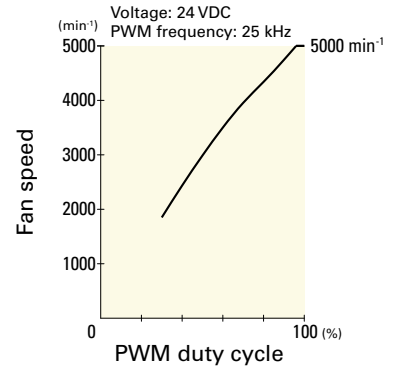

## Dimensions (unit: mm)

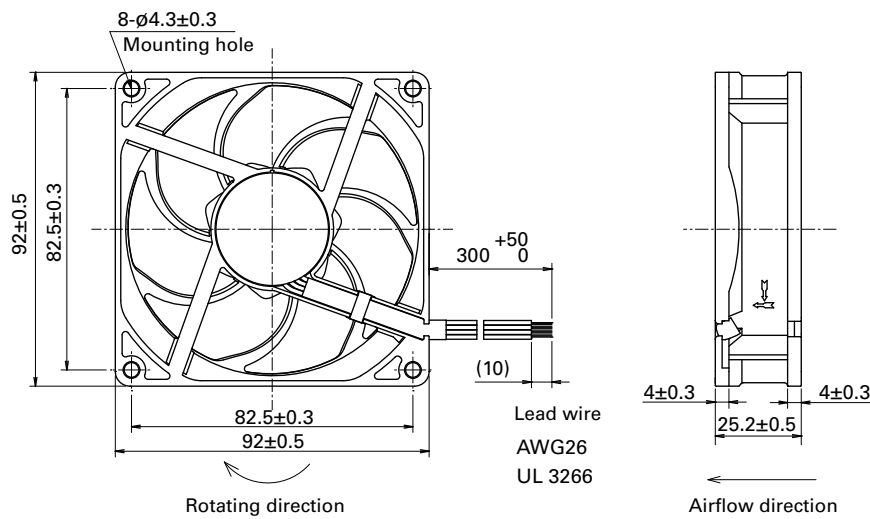

勝特力電材超市-龍山店 886-3-5773766  
 勝特力電材超市-光復店 886-3-5729570  
 勝特力电子(上海) 86-21-34970699  
 勝特力电子(深圳) 86-755-83298787  
<http://www.100y.com.tw>

DC  
Wide Temperature Range Fan 92 mm sq.

## Reference Dimensions of Mounting Holes and Vent Opening (unit: mm)

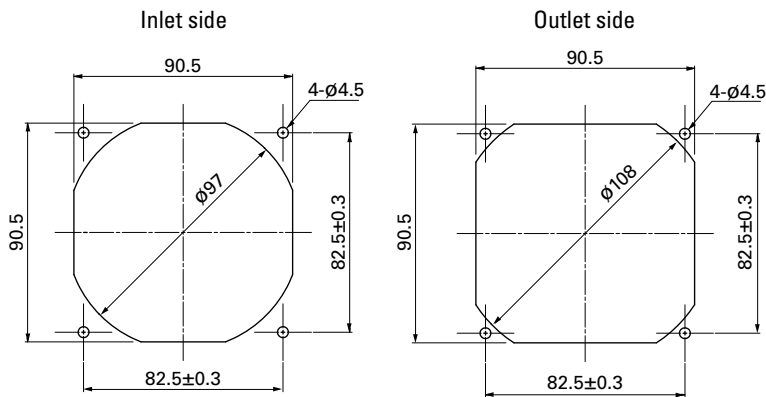

## Options

Finger guards

page: p. 532

Model no.: 109-099E, 109-099H, 109-099C