



120×120×38 mm

San Ace 120L 9LG type

勝特力電材超市-龍山店 886-3-5773766
 勝特力電材超市-光復店 886-3-5729570
 勝特力電子(上海) 86-21-34970699
 勝特力電子(深圳) 86-755-83298787
<http://www.100y.com.tw>

General Specifications

- Material Frame: Aluminum, Impeller: Plastic (Flammability: UL 94V-1)
- Expected life See the table below. (L10 life: 90% survival rate for continuous operation in free air at 60°C, rated voltage)
- Motor protection function Locked rotor burnout protection, Reverse polarity protection
For details, please refer to p. 547.
- Dielectric strength 50/60 Hz, 500 VAC, for 1 minute (between lead wire conductors and frame)
- Insulation resistance 10 MΩ or more with a 500 VDC megger (between lead wire conductors and frame)
- Sound pressure level (SPL) At 1 m away from the air inlet
- Storage temperature -30 to +70°C (Non-condensing)
- Lead wire ⊕Red ⊖Black (Sensor) Yellow (Control) Brown
(For models without PWM control function, there is no speed control wiring.)
- Mass 420 g

Specifications

The models listed below **have pulse sensors with PWM control function.**

Model no.	Rated voltage [V]	Operating voltage range [V]	PWM duty cycle* [%]	Rated current [A]	Rated input [W]	Rated speed [min ⁻¹]	Max. airflow [m ³ /min] [CFM]	Max. static pressure [Pa] [inchH ₂ O]	SPL [dB (A)]	Operating temperature [°C]	Expected life [h]	
9LG1212P1G001	12	8.0 to 13.8	100	3.2	38.4	6550	7.0 247.1	370 1.48	62	-20 to +70	180000/60°C	
			20	0.24	2.88	2000	2.13 75.2	34.4 0.13	36			
9LG1212P1S001			100	2.2	26.4	5600	6.0 211.8	270 1.08	58			
			20	0.24	2.88	2000	2.13 75.2	34.4 0.13	36			
9LG1212P1H001			100	1.4	16.8	4700	5.0 176.5	190 0.76	54			
			20	0.24	2.88	2000	2.13 75.2	34.4 0.13	36			
9LG1224P1G001		24	15 to 30	100	1.6	38.4	6550	7.0 247.1	370 1.48			62
				20	0.12	2.88	2000	2.13 75.2	34.4 0.13			36
9LG1224P1S001				100	1.1	26.4	5600	6.0 211.8	270 1.08			58
				20	0.12	2.88	2000	2.13 75.2	34.4 0.13			36
9LG1224P1H001				100	0.7	16.8	4700	5.0 176.5	190 0.76			54
				20	0.12	2.88	2000	2.13 75.2	34.4 0.13			36
9LG1248P1G001	48	36 to 60	100	0.8	38.4	6550	7.0 247.1	370 1.48	62			
			20	0.08	3.84	2000	2.13 75.2	34.4 0.13	36			
9LG1248P1S001			100	0.55	26.4	5600	6.0 211.8	270 1.08	58			
			20	0.08	3.84	2000	2.13 75.2	34.4 0.13	36			
9LG1248P1H001			100	0.35	16.8	4700	5.0 176.5	190 0.76	54			
			20	0.08	3.84	2000	2.13 75.2	34.4 0.13	36			

* PWM frequency: 25 kHz. Fan does not rotate when PWM duty cycle is 0%.

The following sensor and control options are available for selection.

Differs according to the model. Refer to the table on pp. 576 to 577. Without sensor Pulse sensor Lock sensor

The models listed below **have pulse sensors.**

Model no.	Rated voltage [V]	Operating voltage range [V]	Rated current [A]	Rated input [W]	Rated speed [min ⁻¹]	Max. airflow [m ³ /min] [CFM]	Max. static pressure [Pa] [inchH ₂ O]	SPL [dB (A)]	Operating temperature [°C]	Expected life [h]
9LG1212F1001	12	8 to 13.8	0.39	4.68	2800	3 106	67.6 0.27	39	-20 to +70	180000/60°C
9LG1212M1001			0.22	2.64	2100	2.2 77.7	37.9 0.15	33		
9LG1224A1001	24	15 to 30	0.37	8.88	3700	3.9 137.8	117.8 0.47	48		
9LG1224F1001			0.19	4.56	2800	3 106	67.6 0.27	39		
9LG1224M1001			0.11	2.64	2100	2.2 77.7	37.9 0.15	33		
9LG1248F1001	48	36 to 60	0.11	5.28	2800	3 106	67.6 0.27	39		
9LG1248M1001			0.07	3.36	2100	2.2 77.7	37.9 0.15	33		

The following sensor and control options are available for selection.

Available for all models. Without sensor Lock sensor

Airflow - Static Pressure Characteristics / PWM Duty - Speed Characteristics Example

9LG1212P1G001 With pulse sensor with PWM control function

PWM duty cycle

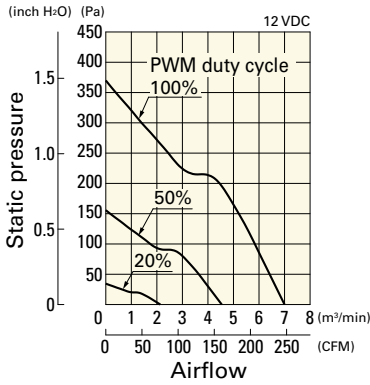

Operating voltage range

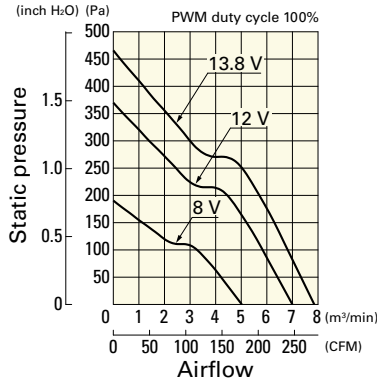

PWM duty - Speed characteristics example

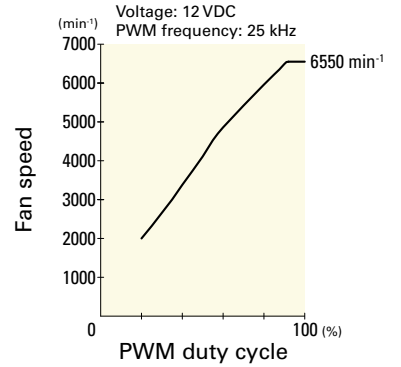

9LG1212P1S001 With pulse sensor with PWM control function

PWM duty cycle

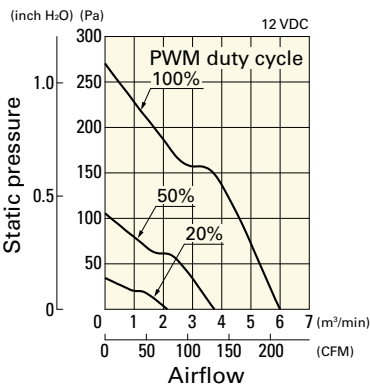

Operating voltage range

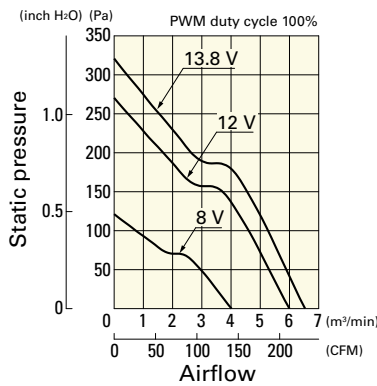

PWM duty - Speed characteristics example

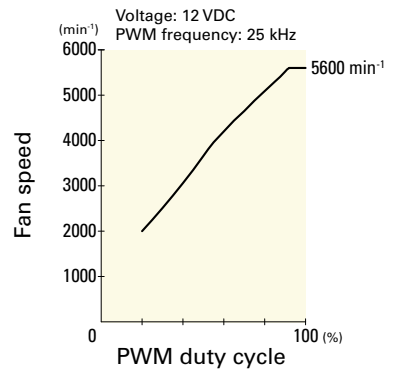

9LG1212P1H001 With pulse sensor with PWM control function

PWM duty cycle

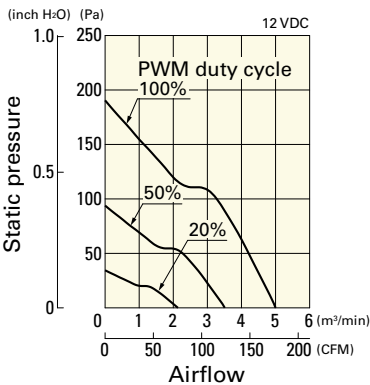

Operating voltage range

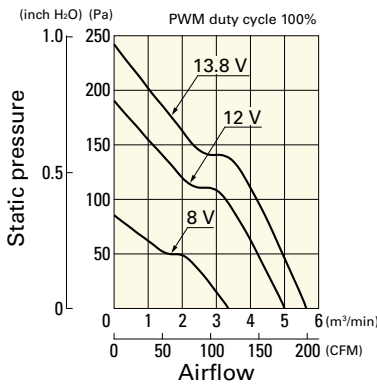

PWM duty - Speed characteristics example

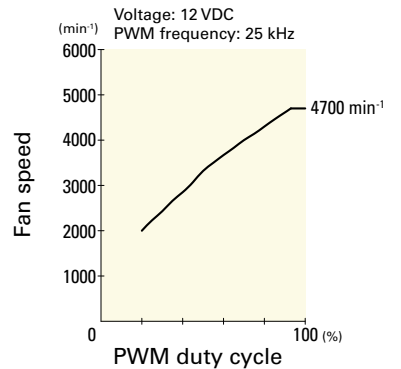

9LG1224P1G001 With pulse sensor with PWM control function

PWM duty cycle

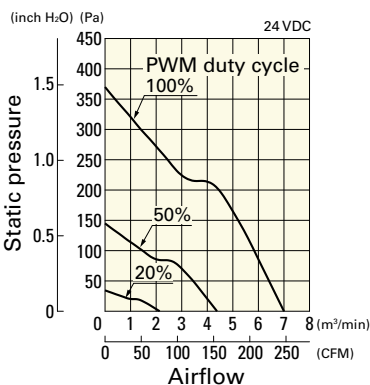

Operating voltage range

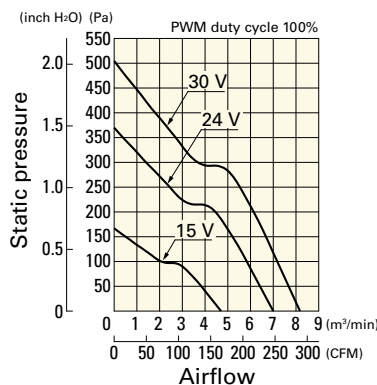

PWM duty - Speed characteristics example

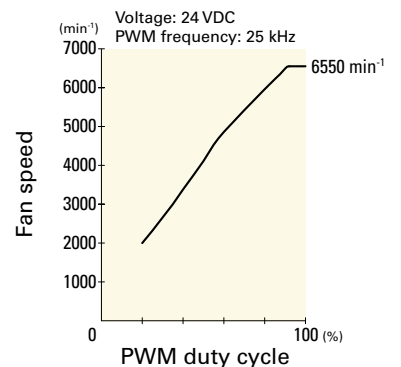

DC

Long Life Fan 120 mm sq.

Airflow - Static Pressure Characteristics / PWM Duty - Speed Characteristics Example

9LG1224P1S001 With pulse sensor with PWM control function

PWM duty cycle

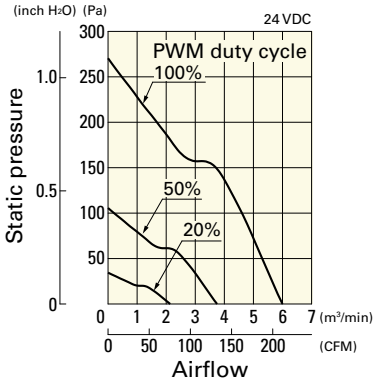

Operating voltage range

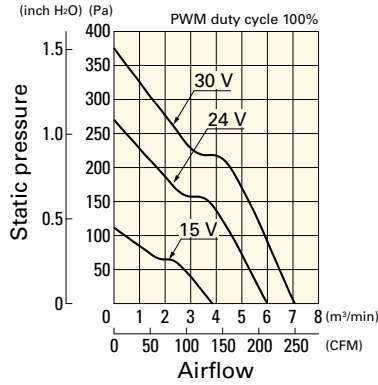

PWM duty - Speed characteristics example

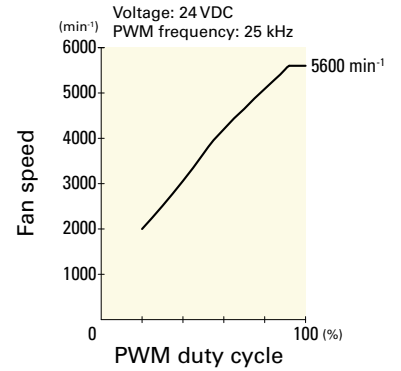

9LG1224P1H001 With pulse sensor with PWM control function

PWM duty cycle

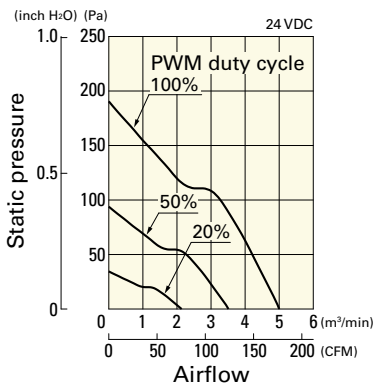

Operating voltage range

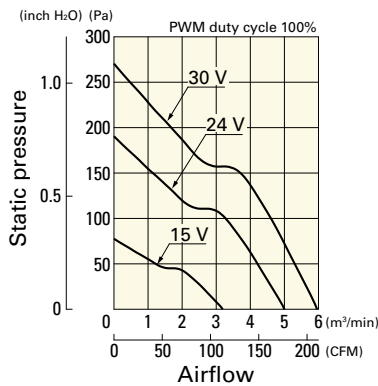

PWM duty - Speed characteristics example

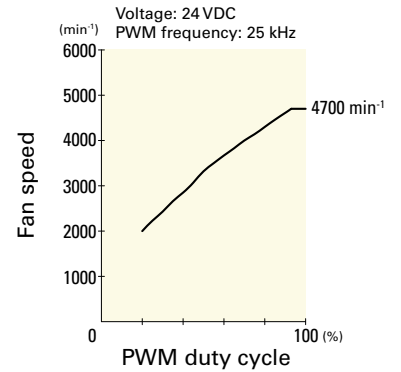

9LG1248P1G001 With pulse sensor with PWM control function

PWM duty cycle

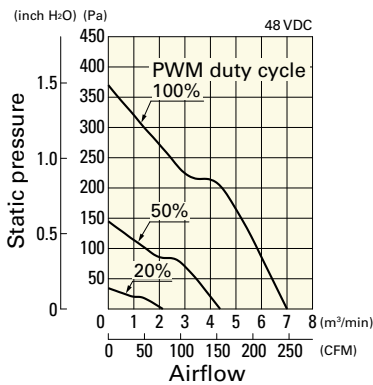

Operating voltage range

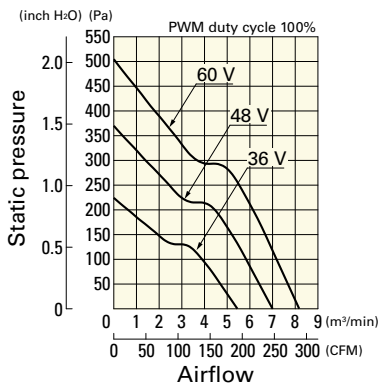

PWM duty - Speed characteristics example

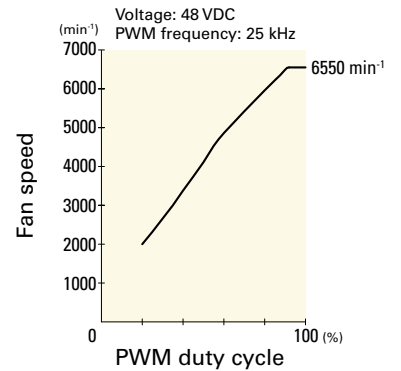

9LG1248P1S001 With pulse sensor with PWM control function

PWM duty cycle

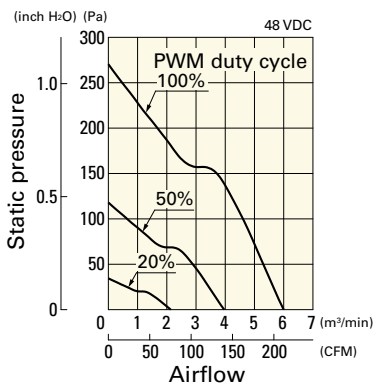

Operating voltage range

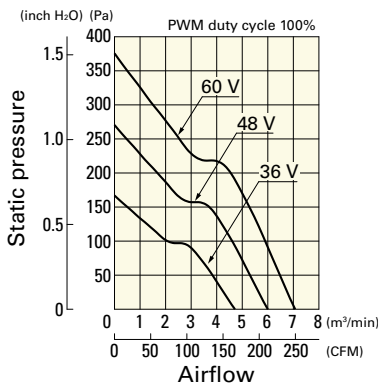

PWM duty - Speed characteristics example

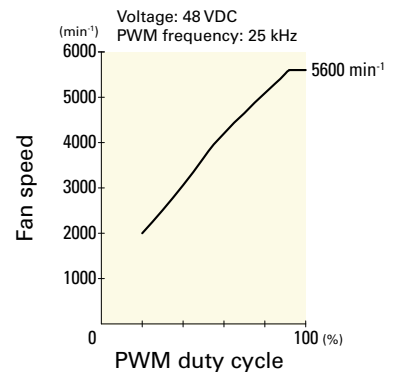

Airflow - Static Pressure Characteristics / PWM Duty - Speed Characteristics Example

9LG1248P1H001 With pulse sensor with PWM control function

PWM duty cycle

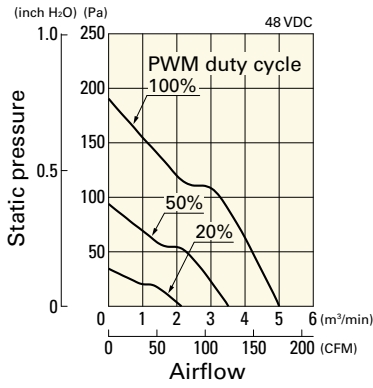

Operating voltage range

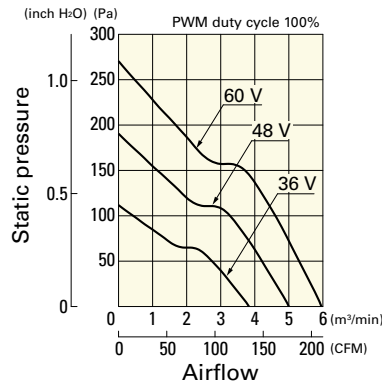

PWM duty - Speed characteristics example

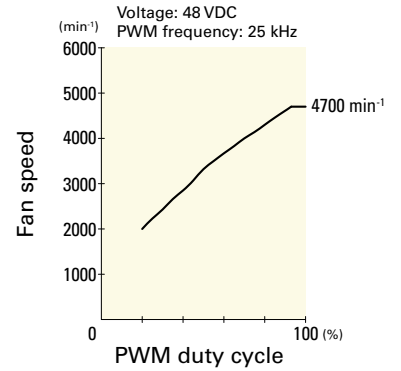

9LG1212F1001 With pulse sensor

Operating voltage range

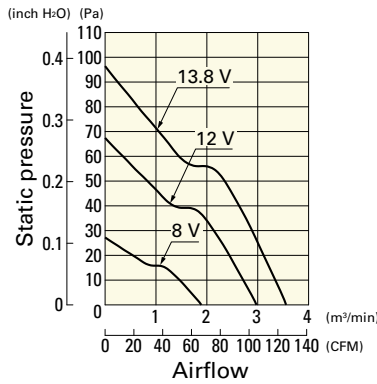

9LG1212M1001 With pulse sensor

Operating voltage range

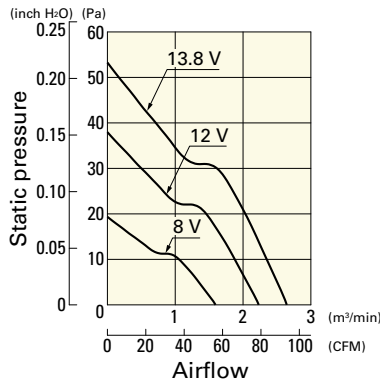

9LG1224A1001 With pulse sensor

Operating voltage range

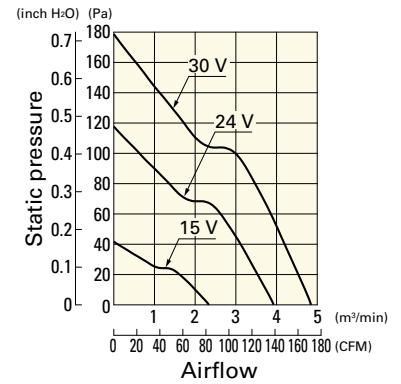

9LG1224F1001 With pulse sensor

Operating voltage range

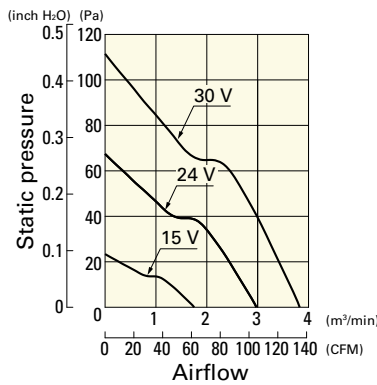

9LG1224M1001 With pulse sensor

Operating voltage range

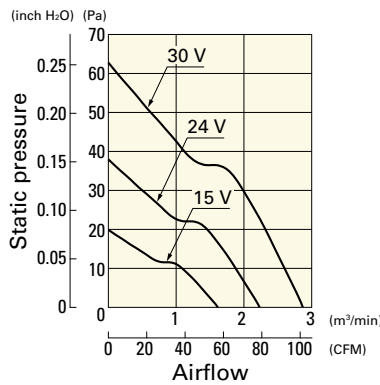

9LG1248F1001 With pulse sensor

Operating voltage range

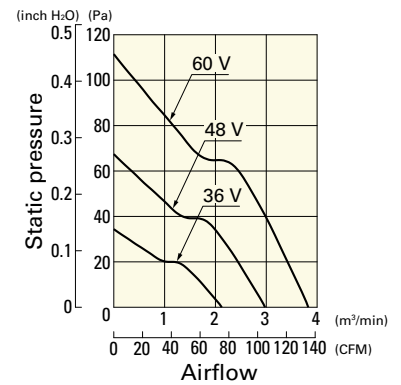

9LG1248M1001 With pulse sensor

Operating voltage range

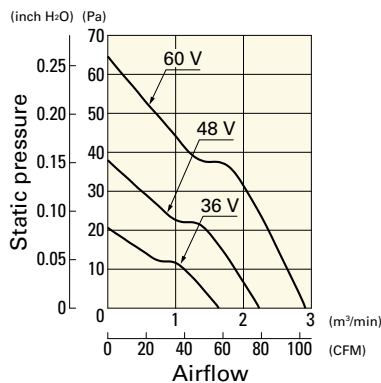

DC

Long Life Fan 120 mm sq.

Dimensions (unit: mm)

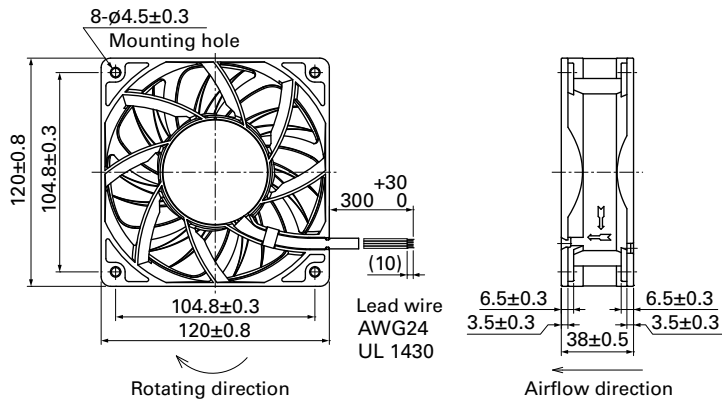

Reference Dimensions of Mounting Holes and Vent Opening (unit: mm)

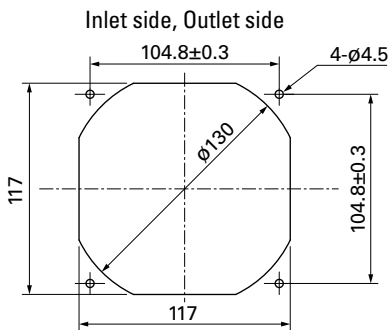

Options

Finger guards

page: p. 533

Model no.: 109-019E, 109-019K, 109-019C, 109-019H

Resin finger guards

page: p. 539

Model no.: 109-1000G

Resin filter kits

page: p. 540

Model no.: 109-1000F13 (13PPI), 109-1000F20 (20PPI),
 109-1000F30 (30PPI), 109-1000F40 (40PPI)