

Splash Proof Fan

勝特力電材超市-龍山店 886-3-5773766
 勝特力電材超市-光復店 886-3-5729570
 勝特力電子(上海) 86-21-34970699
 勝特力電子(深圳) 86-755-83298787
<http://www.100y.com.tw>

IP68 



92x92x25 mm

San Ace 92W 9WL type   

DC
 Splash Proof Fan 92 mm sq.

General Specifications

- Material Frame: Aluminum (Black coating), Impeller: Plastic (Flammability: UL 94V-1)
- Expected life See the table below. (L10 life: 90% survival rate for continuous operation in indoor free air at 60°C, rated voltage)
- Motor protection function Locked rotor burnout protection, Reverse polarity protection
 For details, please refer to p. 547.
- Dielectric strength 50/60 Hz, 500 VAC, for 1 minute (between lead wire conductors and frame)
- Insulation resistance 10 MΩ or more with a 500 VDC megger (between lead wire conductors and frame)
- Sound pressure level (SPL) At 1 m away from the air inlet
- Storage temperature -30 to +70°C (Non-condensing)
- Lead wire ⊕Red ⊖Black (Sensor) Yellow (Control) Brown
 (For models without PWM control function, there is no speed control wiring.)
- Mass 170 g
- Ingress protection IP68

Specifications

The models listed below **have pulse sensors with PWM control function.**

Model no.	Rated voltage [V]	Operating voltage range [V]	PWM duty cycle* [%]	Rated current [A]	Rated input [W]	Rated speed [min ⁻¹]	Max. airflow [m ³ /min] [CFM]	Max. static pressure [Pa] [inchH ₂ O]	SPL [dB (A)]	Operating temperature [°C]	Expected life [h]	
9WL0912P4J001	12	10.8 to 13.2	100	0.42	5.04	5000	2.2 77.7	105 0.42	44	-20 to +70	180000/60°C	
			20	0.04	0.48	1200	0.52 18.4	6.04 0.024	11			
9WL0912P4G001			100	0.3	3.6	4400	1.93 68.2	81 0.33	40			
			20	0.04	0.48	1000	0.43 15.1	4.18 0.016	8			
9WL0912P4S001			100	0.22	2.64	3850	1.69 59.7	62.1 0.25	37			
			30	0.04	0.48	1400	0.61 21.5	8.21 0.032	13			
9WL0912P4H001		100	0.15	1.8	3150	1.38 48.7	41.6 0.17	32				
		30	0.04	0.48	1100	0.48 16.9	5.07 0.02	9				
9WL0924P4J001		24	21.6 to 26.4	100	0.21	5.04	5000	2.2 77.7	105 0.42			44
				20	0.02	0.48	1100	0.48 16.9	5.07 0.02			9
9WL0924P4S001				100	0.11	2.64	3850	1.69 59.7	62.1 0.25			37
				30	0.02	0.48	1300	0.57 20.1	7.08 0.028			12
9WL0924P4H001	100			0.07	1.68	3150	1.38 48.7	41.6 0.17	32			
	30			0.02	0.48	1000	0.43 15.1	4.18 0.016	8			

* PWM frequency: 25 kHz. Fan does not rotate when PWM duty cycle is 0%.

The following sensor and control options are available for selection.

Differs according to the model. Refer to the table on p. 579. **Without sensor** **Pulse sensor** **Lock sensor**

The models listed below **have pulse sensors.**

Model no.	Rated voltage [V]	Operating voltage range [V]	Rated current [A]	Rated input [W]	Rated speed [min ⁻¹]	Max. airflow [m ³ /min] [CFM]	Max. static pressure [Pa] [inchH ₂ O]	SPL [dB (A)]	Operating temperature [°C]	Expected life [h]
9WL0912M4001	12	10.2 to 13.8	0.08	0.96	2400	1.05 37.1	24.1 0.097	24	-20 to +70	180000/60°C
9WL0924F4001	24	20.4 to 27.6	0.05	1.2	2800	1.22 43.1	32.8 0.13	29		
9WL0924M4001			0.04	0.96	2400	1.05 37.1	24.1 0.097	24		

The following sensor and control options are available for selection.

Available for all models. **Without sensor**

Differs according to the model. Refer to the table on p. 579. **Lock sensor**

Airflow - Static Pressure Characteristics / PWM Duty - Speed Characteristics Example

9WL0912P4J001 With pulse sensor with PWM control function

PWM duty cycle

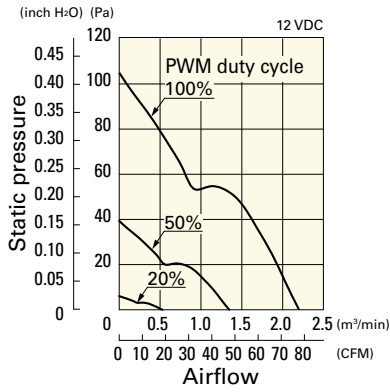

Operating voltage range

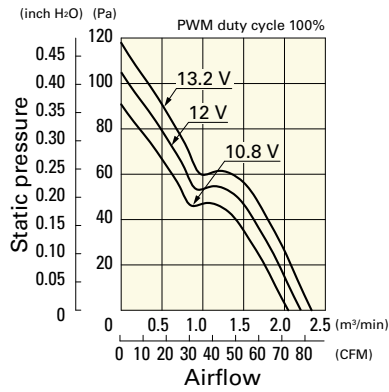

PWM duty - Speed characteristics example

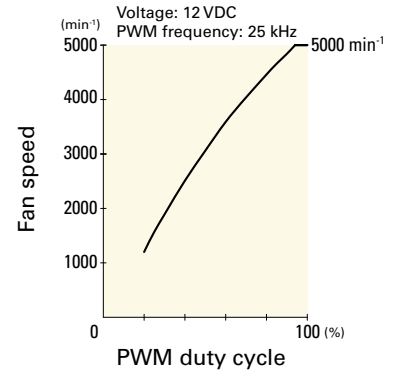

9WL0912P4G001 With pulse sensor with PWM control function

PWM duty cycle

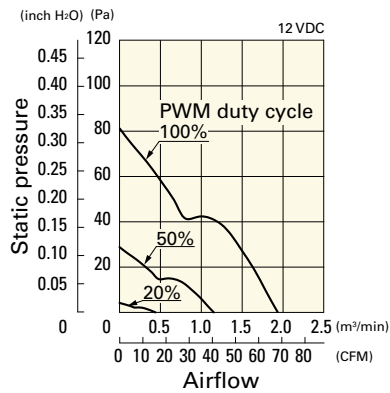

Operating voltage range

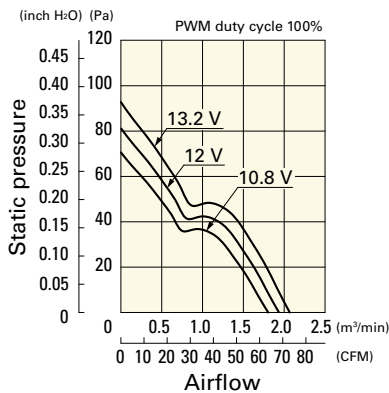

PWM duty - Speed characteristics example

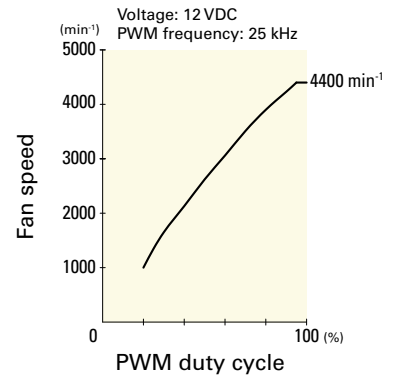

9WL0912P4S001 With pulse sensor with PWM control function

PWM duty cycle

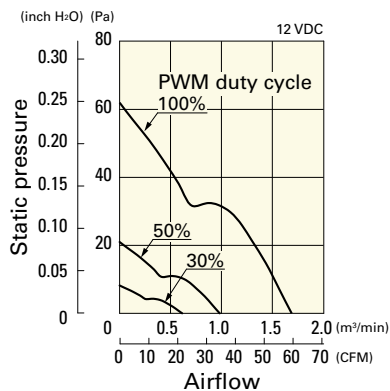

Operating voltage range

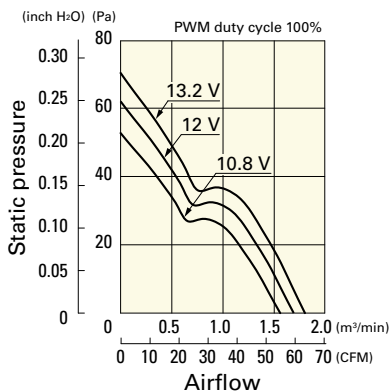

PWM duty - Speed characteristics example

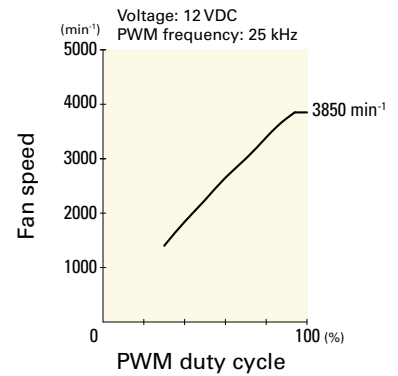

9WL0912P4H001 With pulse sensor with PWM control function

PWM duty cycle

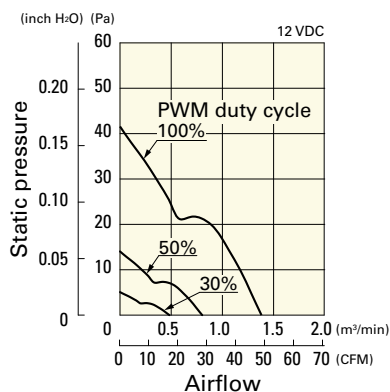

Operating voltage range

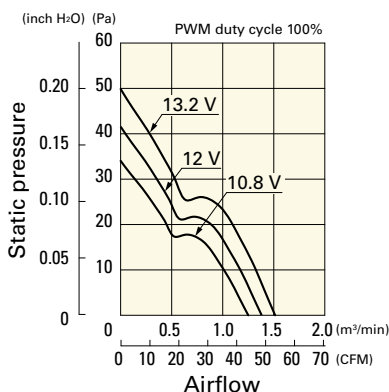

PWM duty - Speed characteristics example

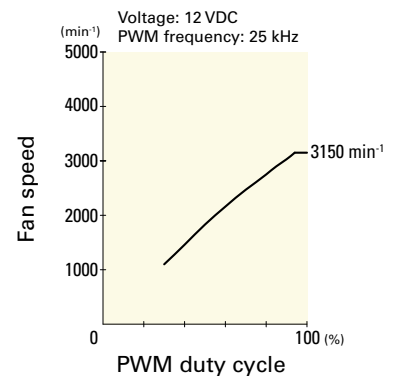

Airflow - Static Pressure Characteristics / PWM Duty - Speed Characteristics Example

9WL0924P4J001 With pulse sensor with PWM control function

PWM duty cycle

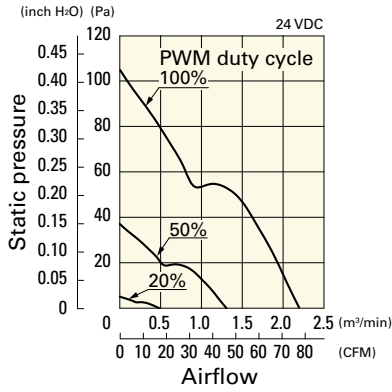

Operating voltage range

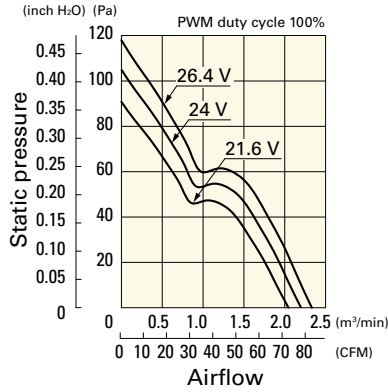

PWM duty - Speed characteristics example

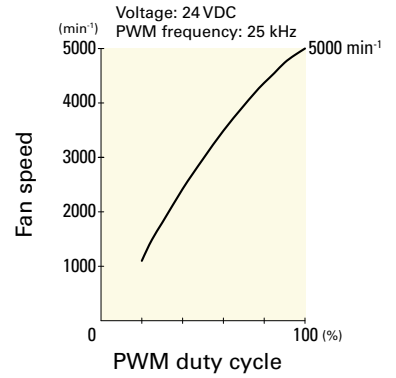

9WL0924P4S001 With pulse sensor with PWM control function

PWM duty cycle

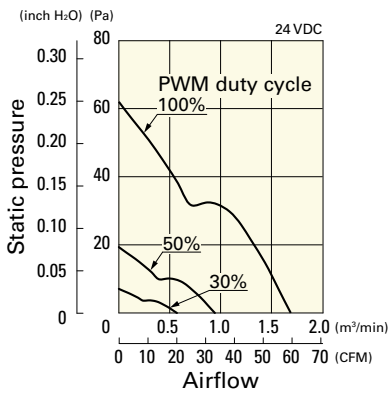

Operating voltage range

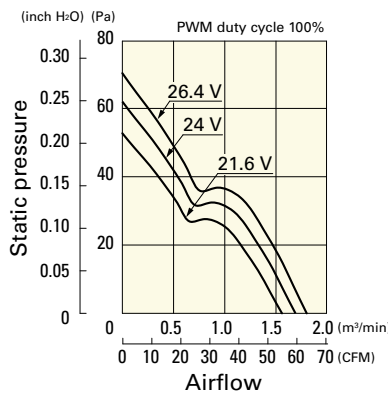

PWM duty - Speed characteristics example

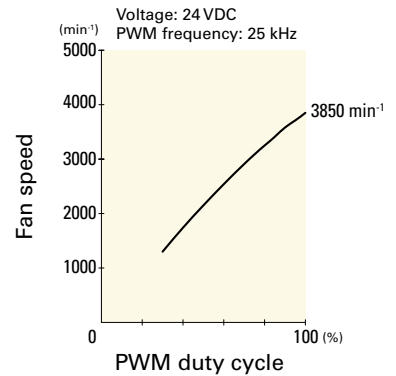

9WL0924P4H001 With pulse sensor with PWM control function

PWM duty cycle

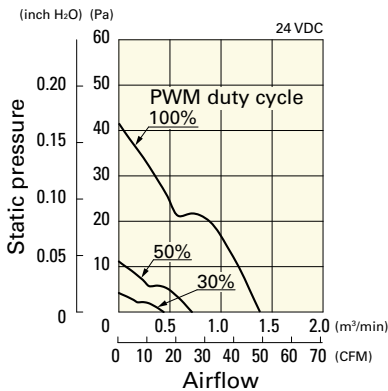

Operating voltage range

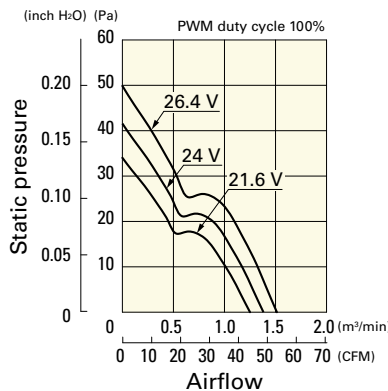

PWM duty - Speed characteristics example

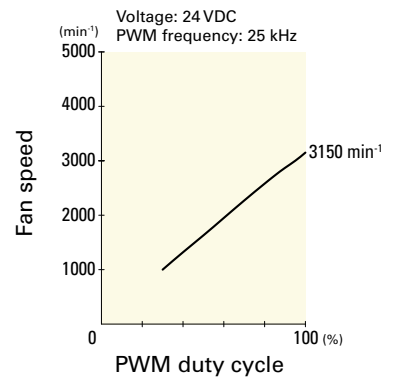

9WL0912M4001 With pulse sensor

Operating voltage range

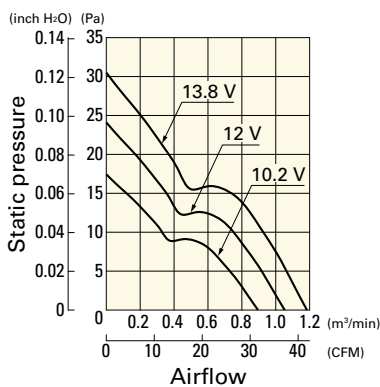

9WL0924F4001 With pulse sensor

Operating voltage range

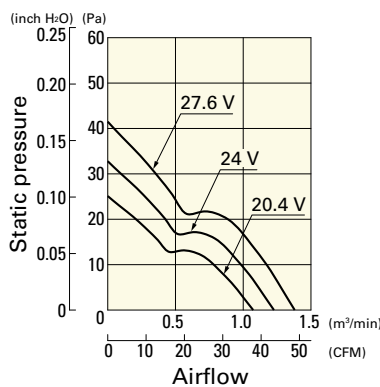

9WL0924M4001 With pulse sensor

Operating voltage range

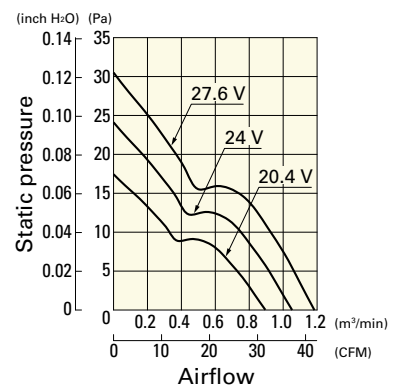

■ Dimensions (unit: mm)

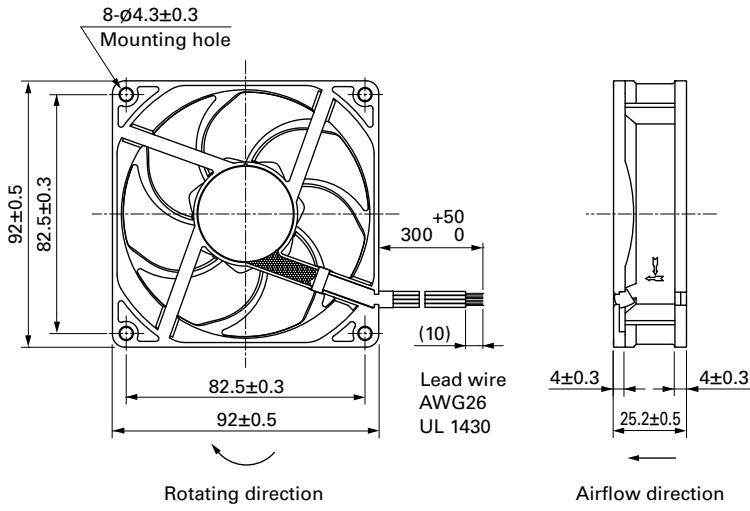

■ Reference Dimensions of Mounting Holes and Vent Opening (unit: mm)

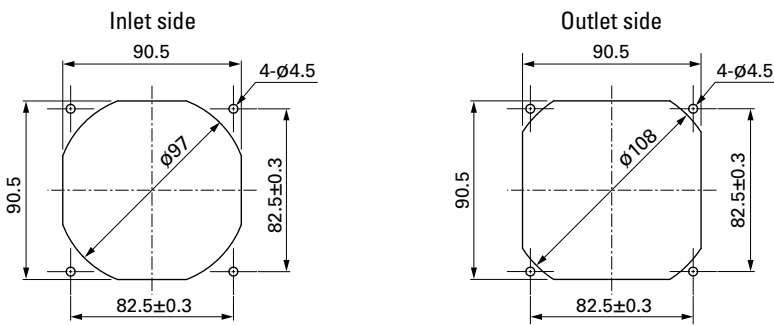

■ Options

Finger guards

page: p. 532

Model no.: 109-099E, 109-099H, 109-099C

Resin finger guards

page: p. 539

Model no.: 109-1001G