

AC AXIAL FAN

勝特力材料 886-3-5753170
 勝特力电子(上海) 86-21-34970699
 勝特力电子(深圳) 86-755-83298787
[Http://www.100y.com.tw](http://www.100y.com.tw)

Customer :

Model No : SA12038S2HL

SPECIFICATION

Item	Specification / Condition
Dimension 尺寸	: 120x120x38.5 mm
Bearing System 軸承	: Sleeve Bearing
Rated Voltage 額定電壓	: 220 VAC
Operating Voltage 工作電壓	: 200 VAC — 240 VAC
Start-up Voltage 啟動電壓	: 160 VAC Normally
Operating Frequency 操作頻率	: 50 / 60 HZ
Rated Current 額定電流	: 0.14 / 0.12 Amp Normally
Power Consumption 消耗功率	: 22 / 18 Watt Normally
Rated Speed 轉速	: 2600 / 2950 RPM ± 10%
Air Flow 風量	: 2.29 / 2.6 m ³ / min (81 / 92 CFM)
Static Air Pressure 靜壓	: 6.7 / 6.9 mmH2O
Noise Level 噪音	: 43 / 47 dBA
Motor Protection Type 馬達保護形式	: By Impedance
Life Expectancy 壽命	: 30000 Hours at 25°C
Operation Temperature 操作溫度	: - 10°C to + 70°C
Net Weight 淨重	: 480 Grams
Packing 包裝	: 40 Pcs Per Carton
Safety Approval 安規	: [V] UL [M] TUV [M] CE

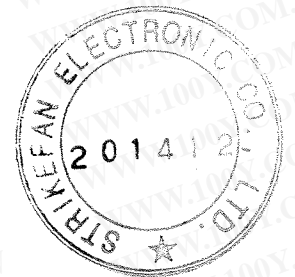

Strikefan Electronic Co., Ltd

A:MECHANICAL

- A-1 Dimension -----See Attached
- A-2) Frame----- Die Cast Aluminum Painted Black
- A-3) Fan Blade -----Plastic With Fiber Glass UL 94V-0

B:ENVIRONMENTAL

- B-1) Operating Temperature ---- -10°C TO $+70^{\circ}\text{C}$
- B-2) Storage Temperature----- -40°C TO $+80^{\circ}\text{C}$
- B-3) Drop Test:
In Minimum Packaging Condition Fans Withstands Each One Drop Of Three Faces From 30cm Distance Height Onto 10mm Thickness Of Wooden Board
- B-4) Vibration Test:
Frequency:10-50HZ Amplitude
X.Y.X Direction Each For 1HR
- B-5) Shock Test:
Apply Peak Acceleration 50g and Keep Duration of The Pulse For 11ms (Half Sine Wave)
- B-6) Insulation Resistance:
100M Ohm minimum at DC 500V.
- B-7) Dielectric Strength:
1500VAC For 01sec(<0.5mA ALLOWABLE,BETWEEN LEAD AND HOUSING.)

C:ACOUSTICAL NOISE:

C-1) Measurement Ste-up

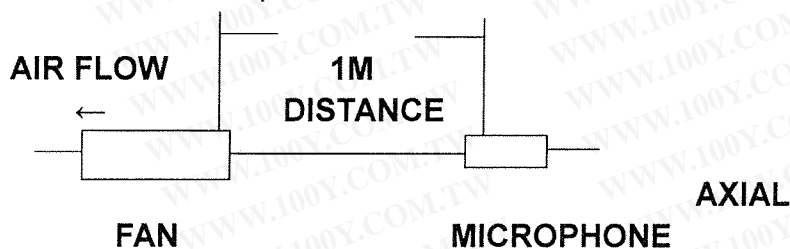

- C-2) Measurement Performed In Anechoic Est Chamber Under Free Air Condition
- C-3) Chamber Back Ground NOISE 17dB Max.
- C-4) Reading Taken From Spetroun Analyzer.

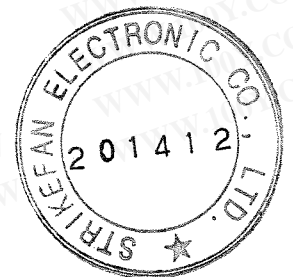

D:STATICS PRESSURE VS AIR FLOW CURVE :

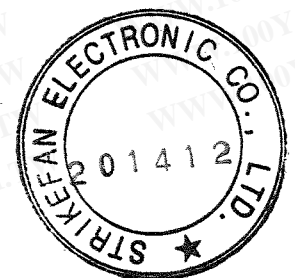
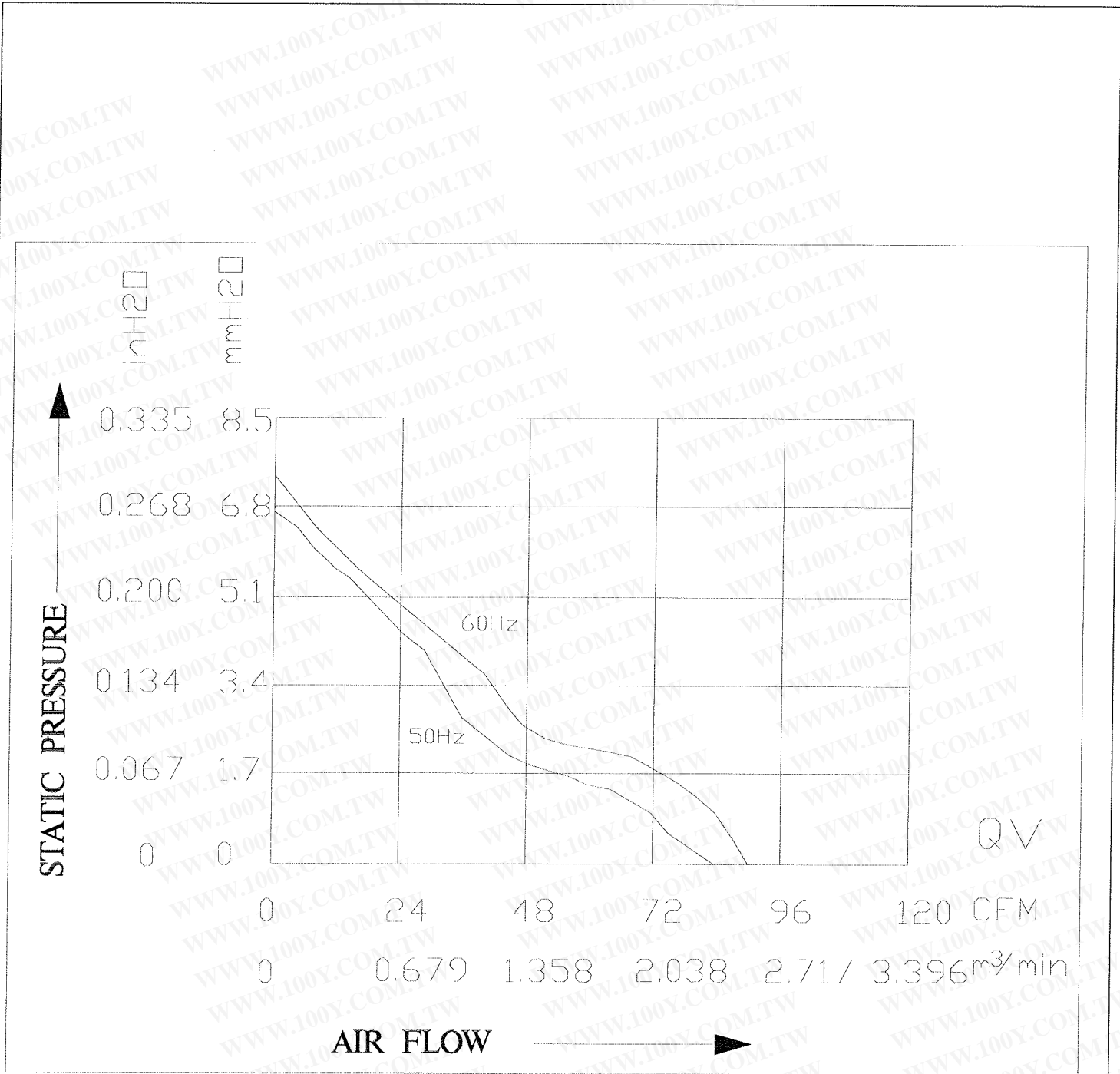

E:OUTLINE STYLING & DIMENSIONS :

Unit: MM

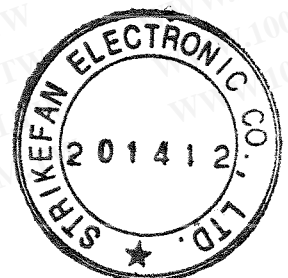
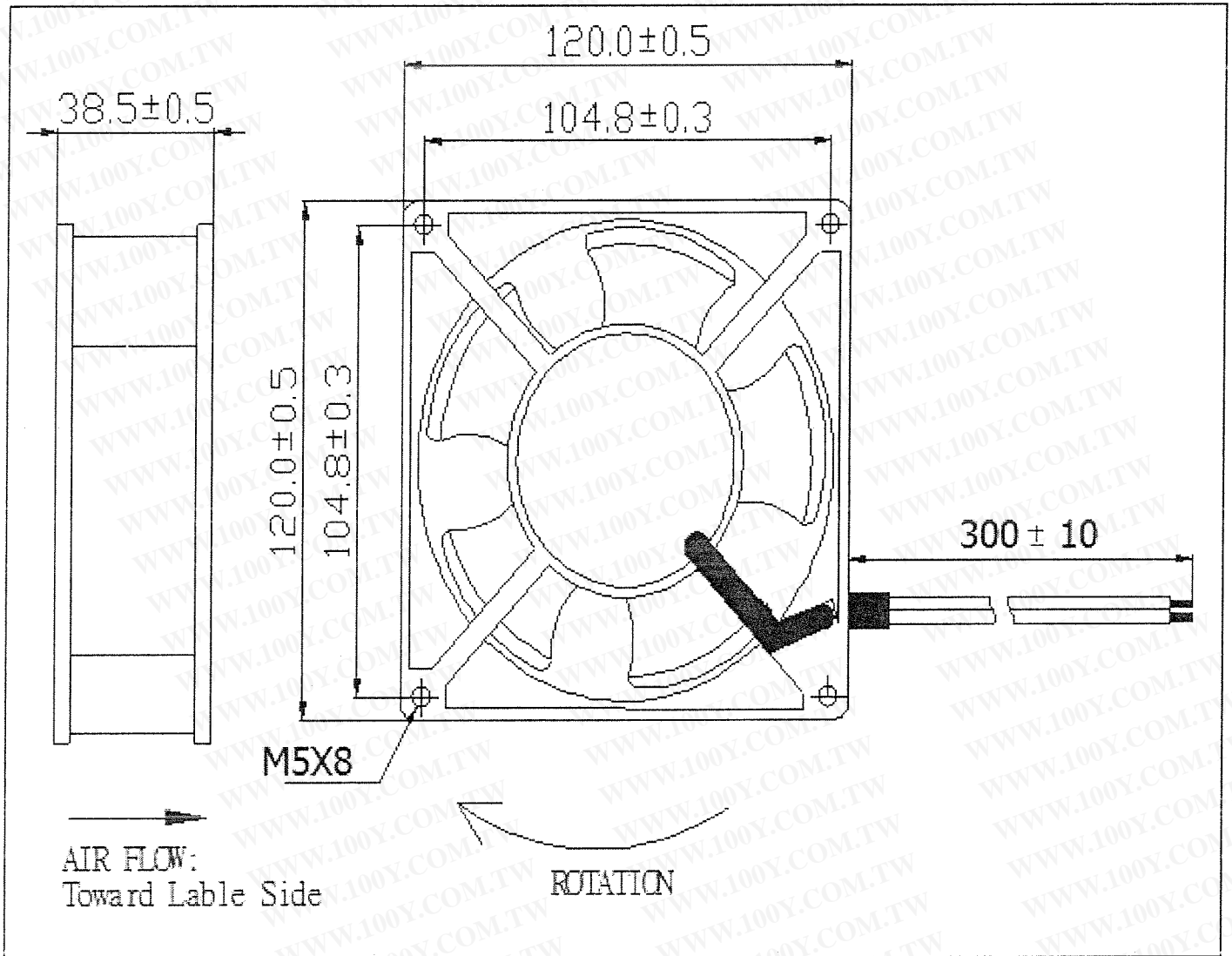



GPWV2.E350026
Fans, Electric - Component

[Page Bottom](#)

Fans, Electric - Component

[See General Information for Fans, Electric - Component](#)

STRIKEFAN ELECTRONIC CO LTD

E350026

3RD FL, 236 CHUNG HSING RD

HSICHIH

NEW TAIPEI, 221 TAIWAN

AC fans, Models SA8025(A)1HL(Y) (@), SA8038(A)1H(Y) (@), SA9225(A)1H(B)(Y) (@), SA12025(A)1H(B)(Y) (@), SA12038(A)1H(B)(Y) (@), SA15050(A)1H(B)(Y) (@).

Models SA8025(A)2(B)(C)(Y) (#), SA8038(A)2(B)(C)(Y) (#), SA9225(A)2(B)(C)(Y) (#), SA12025(A)2(B)(C)(Y) (#), SA12038(A)2(B)(C)(Y) (#), SA15050(A)2(B)(C)(Y) (#).

Note: (@) (A) may be S or B, (B) may be L or T, (Y) may be letter A through Z and/or 0 through 9, or blank

(#) (A) may be S or B, (B) may be X,H,M or L, (C) may be T or L, (Y) may be letter A through Z and/or 0 through 9, or blank

Marking: Company name and model designation.

[Last Updated](#) on 2011-09-26

[Questions?](#)

[Print this page](#)

[Notice of Disclaimer](#)

[Page Top](#)

[Copyright](#)

The appearance of a company's name or product in this database does not in itself assure that products so identified have been manufactured under UL's Follow-Up Service. Only those products bearing the UL Mark should be considered to be Listed and covered under UL's Follow-Up Service. Always look for the Mark on the product.

UL permits the reproduction of the material contained in the Online Certification Directory subject to the following conditions. The Guide Information, Designs and/or Listings (files) must be presented in their entirety and in a non-misleading manner, without any manipulation of the data (or drawings). 2. The statement "Reprinted from the Online Certifications Directory with permission from Underwriters Laboratories Inc." must appear adjacent to the extracted material. In addition, the reprinted material must include a copyright notice in the following format: "Copyright 2011 Underwriters Laboratories Inc."

An independent organization working for a safer world with integrity, precision and knowledge.

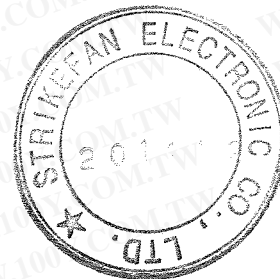

Zertifikat

Certificate

勝特力材料 886-3-5753170
勝特力电子(上海) 86-21-34970699
勝特力电子(深圳) 86-755-83298787
[Http://www.100y.com.tw](http://www.100y.com.tw)

TÜVRheinland®

Zertifikat Nr. Certificate No. Blatt Page
R 50217044 0001

Ihr Zeichen Client Reference Unser Zeichen Our Reference Ausstellungsdatum Date of Issue
05-JJH- 16026803 003 15.11.2011 (day/mo/yr)

Genehmigungsinhaber License Holder Fertigungsstätte Manufacturing Plant
Strikefan Electronic Co., Ltd 05-YL-16026803 001
C/O: 3F., No.236, Chung Hsing Rd.
Hsichih City, Taipei Hsien 22158
Taiwan

Prüfzeichen Test Mark

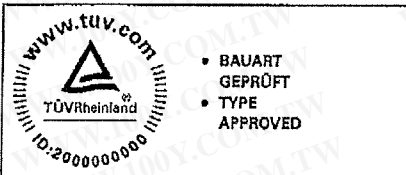

Geprüft nach Tested acc. to
EN 60335-1:2002+A1+A11+A12+A2+A13+A14
EN 60335-2-80:2003+A1+A2
EN 62233:2008

Zertifiziertes Produkt (Geräteidentifikation)
Certified Product (Product Identification)

Lizenzentgelte - Einheit
License Fee - Unit

Ventilator (AC Fan)

Type Designation	Rated Voltage	Rated Current	
SA8025a2bcd SA9225a2bcd	220-240V; 50/60Hz	0.11A	15
SA12025a2bcd	220-240V; 50/60Hz	0.15A	
SA8038a2bcd	220-240V; 50/60Hz	0.16A	
SA12038a2bcd	220-240V; 50/60Hz	0.17A	
SA15050a2bcd	220-240V; 50/60Hz	0.30A	
SA8038a1bcd	220-240V; 50/60Hz	0.23A	

Variable a = B stands for the ball bearing
S stands for the sleeve bearing
Variable b = H; L; M; X stands for the client code
Variable c = T stands for the terminal type
L stands for the lead type

Variable d = A-Z, 0-9 or blank stands for batch of product.

Remark: The labelling requirements acc. to EU Directive 2001/95 have to be observed for distribution within the EEA. The protection against electric shock must be ensured by built-in final appliances.

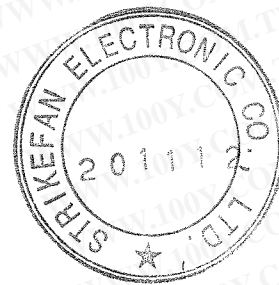

15

Dem Zertifikat liegt unsere Prüf- und Zertifizierungsordnung zugrunde und es bestätigt die Konformität des Produktes mit den oben genannten Standards und Prüfgrundlagen. Zusätzliche Anforderungen in Ländern, in denen das Produkt in Verkehr gebracht werden soll, müssen zusätzlich betrachtet werden. Die Herstellung des zertifizierten Produktes wird überwacht.
This certificate is based on our Testing and Certification Regulation and states the conformity of the product with the standards and testing requirements as indicated above. Any additional requirements in countries where the product is going to be marketed have to be considered additionally. The manufacturing of the certified product is subject to surveillance.

TÜV Rheinland LGA Products GmbH - Tillystraße 2 - 90431 Nürnberg
Tel.: (+49/221)8 06 - 13 71 e-mail: cert-validity@de.tuv.com
Fax: (+49/221)8 06 - 39 35 <http://www.tuv.com/safety>

Zertifizierungsstelle



Dipl.-Ing. (FH) T. Zimmer