

**RoHS** **Pb** **369 Series, TE5®, Time-Lag Fuse**



**Description**

TE5®, Time-lag type, 300V rated and designed in accordance to IEC60127-3.

**Features**

- Lead-free
- Reduced PCB space requirements
- Direct solderable or plug-in versions
- Internationally approved
- Low internal resistance
- Shocksafe casing
- Vibration resistant
- Halogen free

**Agency Approvals**

Agency	Agency File Number	Ampere Range
	E67006	800mA - 6.3A
	JET 1896-31007-2002	1A - 5A
	1023263	1A - 6.3A



**Applications**

- Electronic Ballast

**Electrical Characteristics for Series**

% of Ampere Rating	Opening Time
150%	1 Hour, Minimum
210%	120 sec., Maximum
275%	400 ms., Min.; 10 sec., Max.
400%	150 ms., Min.; 3 sec., Max.
1000%	20 ms., Min.; 150 ms., Max.

**Electrical Characteristics Specifications by Item**

Amp Code	Amp Rating (A)	Voltage Rating (V)	Breaking Capacity	Voltage Drop 1.0 x I <sub>N</sub> max. (mV)	Power Dissipation 1.5 x I <sub>N</sub> max. (mW)	Melting Integral 10 x I <sub>N</sub> min. (A <sup>2</sup> s)	Agency Approvals		
									
0800	0.800	300	50A@300VAC 50-60Hz/cosφ = 1	110	280	3.80	X		
1100	1.00	300		115	400	5.80	X	X	X
1160	1.60	300		95	600	13.50	X	X	X
1200	2.00	300		90	700	21.00	X	X	X
1315	3.15	300		80	1100	55.00	X	X	X
1400	4.00	300		75	1200	100.00	X	X	X
1500	5.00	300		70	1000	90.00	X	X	X
1630	6.30	300		65	1200	126.00	X		X

勝特力材料 886-3-5753170  
 勝特力电子(上海) 86-21-34970699  
 勝特力电子(深圳) 86-755-83298787  
[Http://www.100y.com.tw](http://www.100y.com.tw)

### Temperature Derating Curve

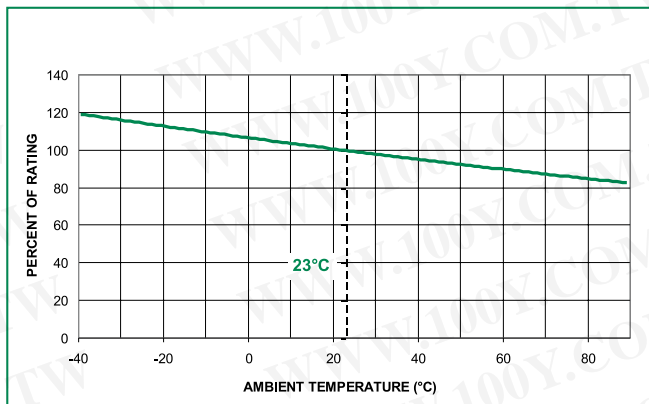

### Average Time Current Curves

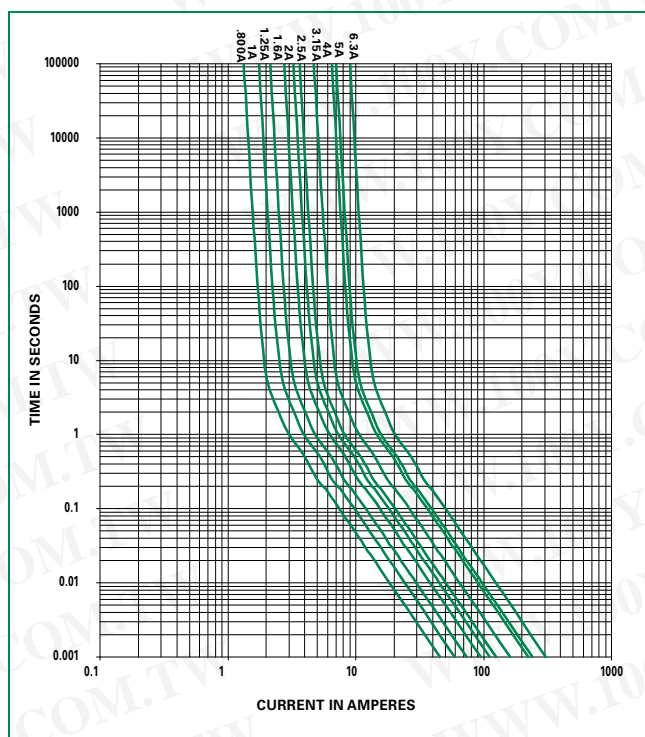

勝特力材料 886-3-5753170  
 勝特力电子(上海) 86-21-34970699  
 勝特力电子(深圳) 86-755-83298787  
[Http://www.100y.com.tw](http://www.100y.com.tw)

### Soldering Parameters - Wave Soldering

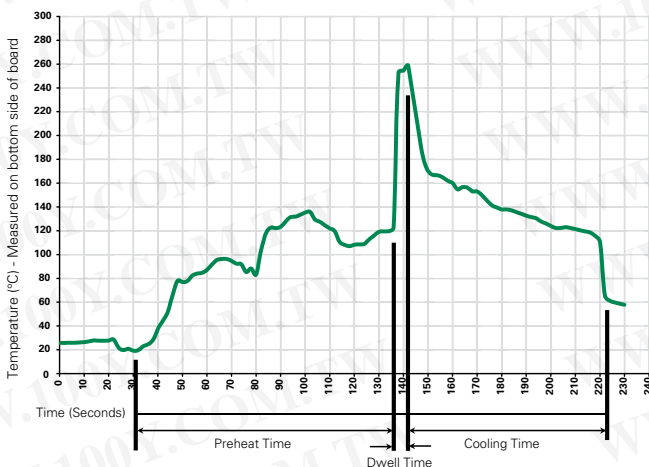

#### Recommended Process Parameters:

Wave Parameter	Lead-Free Recommendation
<b>Preheat:</b> (Depends on Flux Activation Temperature)	(Typical Industry Recommendation)
Temperature Minimum:	100° C
Temperature Maximum:	150° C
Preheat Time:	60-180 seconds
Solder Pot Temperature:	260° C Maximum
Solder Dwell Time:	2-5 seconds

#### Recommended Hand-Solder Parameters:

Solder Iron Temperature: 350° C +/- 5° C  
 Heating Time: 5 seconds max.

**Note: These devices are not recommended for IR or Convection Reflow process.**

## Product Characteristics

<b>Materials</b>	Base/Cap: Brown Thermoplastic Polyamide PA6.6, UL 94 V0 Round Pins: Tin-plated Copper
<b>Lead Pull Strength</b>	10 N (IEC 60068-2-21)
<b>Solderability</b>	260°C, ≤ 3s (Wave) 350°C, ≤ 1s (Soldering Iron)
<b>Soldering Heat Resistance</b>	260°C, 10s (IEC60068-2-20) 350°C, 3s (Soldering Iron)

<b>Operating Temperature</b>	-40°C to +85°C (consider de-rating)
<b>Climatic Category</b>	-40°C / +85°C / 21 days (EN60068-1,-2-1,-2-2,-2-78)
<b>Stock Condition</b>	+10°C to +60°C relative humidity 75% yearly average, without dew, maximum value for 30 days-95%
<b>Vibration Resistance</b>	24 cycles at 15min. Each (EN60068-2-6) 10 - 60 Hz at 0.75 mm amplitude 60 - 2000 Hz at 10g acceleration

## Dimensions

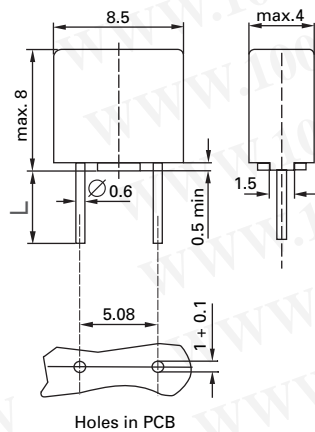

Long Leads (L=18.8mm)  
Short Leads (L=4.3mm)

## Part Numbering System

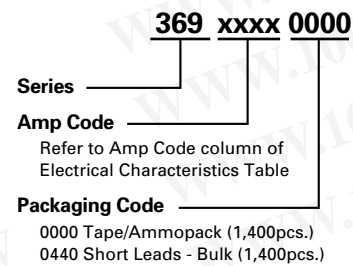

## Packaging

Packaging Option	Packaging Specification	Quantity	Quantity & Packaging Code	Taping Width
<b>369 Series</b>				
Tape & Ammopack	N/A	1,400	0000	N/A
Short Leads	N/A	1,400	0440	N/A

勝特力材料 886-3-5753170  
 勝特力电子(上海) 86-21-34970699  
 勝特力电子(深圳) 86-755-83298787  
[Http://www.100y.com.tw](http://www.100y.com.tw)