

Miniature Fuse, 5 x 20 mm, Time-Lag T, L, 250 VAC



勝特力材料 886-3-5753170
 勝特力电子(上海) 86-21-34970699
 勝特力电子(深圳) 86-755-83298787
[Http://www.100y.com.tw](http://www.100y.com.tw)

IEC 60127-2 · 250VAC · Time-Lag T



Description

- IEC Standard Fuse
- L = Low Breaking Capacity (Glass Tube)

Standards

- IEC 60127-2/3
- UL 248-14
- CSA C22.2 no. 248.14
- Telcordia GR-1089
- UL 60950 / IEC 60950
- ITU-T K.20 and K.21
- TIA-968-A

Approvals

- VDE Certificate Number: 40016601
- UL File Number: E41599

Applications

- Primary Protection in Equipment

References

- Pigtail Type [FST 5x20 Pigtail](#)
- Assembled Fuseholder [OGN-SMD](#)
- Fuse Kit [Fuse Kit FST 5x20](#); [Fuse Kit FST 5x20 / SP 5x20](#)

Weblinks

[pdf-datasheet](#), [html-datasheet](#), [General Product Information](#), [Packaging details](#), [Approvals](#), [CE declaration of conformity](#), [RoHS](#), [CHINA-RoHS](#), [REACH](#), [Distributor-Stock-Check](#), [Detailed request for product](#)

Technical Data

Rated Voltage	250VAC
Rated current	0.02 - 20A
Breaking Capacity	35A - 200A
Characteristic	Time-Lag T
Admissible Ambient Air Temp.	-55 °C to 125 °C
Climatic Category	55/125/21 acc. to IEC 60068-1
Material: Tube	Glass
Material: Endcaps	Nickel-Plated Copper Alloy
Unit Weight	1 g
Storage Conditions	0 °C to 60 °C, max. 70% r.h.
Product Marking	 Rated current, Rated Voltage, Characteristic, Breaking Capacity, Approvals

Dimension

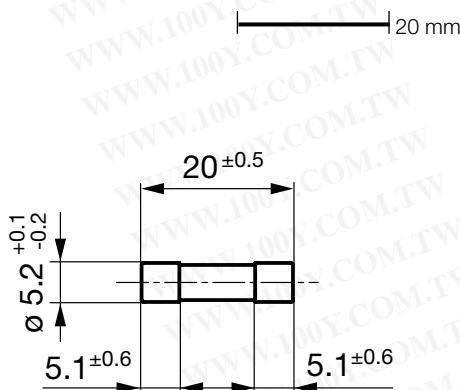





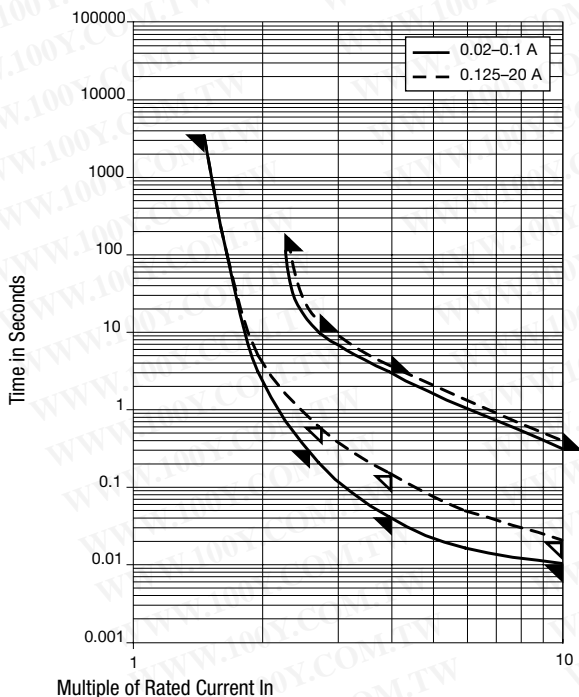

Pre-Arcing Time







Rated Current I_n	1.5 x I_n min.	2.1 x I_n max.	2.75 x I_n min.	2.75 x I_n max.	4.0 x I_n min.	4.0 x I_n max.	10.0 x I_n min.	10.0 x I_n max.
0.02 A	60 min	-	-	-	40 ms	3 s	10 ms	300 ms
0.032 A - 0.1 A	60 min	120 s	200 ms	10 s	40 ms	3 s	10 ms	300 ms
0.125 A - 6.3 A	60 min	120 s	600 ms	10 s	150 ms	3 s	20 ms	300 ms
8 A - 20 A	30 min	120 s	600 ms	10 s	150 ms	3 s	20 ms	300 ms

Time-Current-Curves



All Variants

Rated Current [A]	Rated Voltage [VAC]	Breaking Capacity	Voltage Drop 1.0 I_n max. [mV]	Voltage Drop 1.0 I_n typ. [mV]	Power Dissipation 1.5 I_n max. [mW]	Power Dissipation 1.5 I_n typ. [mW]	Melting I ² t 10.0 Intyp. [A ² s]	     	Order Number
0.02	250	1)	-	2700	-	100	0.0012		0034.3101
0.032	250	1)	5000	3000	1600	200	0.0019	●	0034.3102
0.04	250	1)	4000	2100	1600	200	0.0027	● ● ●	0034.3103
0.05	250	1)	3500	950	1600	125	0.0363	● ● ●	0034.3104
0.063	250	1)	3000	1300	1600	200	0.0401	● ● ●	0034.3105
0.08	250	1)	3000	1100	1600	300	0.057	● ● ●	0034.3106
0.1	250	1)	2500	565	1600	155	0.107	● ● ●	0034.3107
0.125	250	1)	2000	400	1600	200	0.064	● ● ●	0034.3108
0.16	250	1)	1900	415	1600	185	0.23	● ● ●	0034.3109
0.2	250	1)	1500	270	1600	200	0.256	● ● ●	0034.3110
0.25	250	1)	1300	210	1600	200	0.238	● ● ●	0034.3111
0.315	250	1)	1100	170	1600	200	0.544	● ● ●	0034.3112
0.4	250	1)	1000	150	1600	200	0.768	● ● ●	0034.3113
0.5	250	1)	900	160	1600	200	3	● ● ●	0034.3114
0.63	250	1)	300	160	1600	300	4.35	● ● ●	0034.3115
0.8	250	1)	250	120	1600	300	3.85	● ● ●	0034.3116
1	250	1)	150	60	1600	200	3.3	● ● ● ●	0034.3117
1.25	250	1)	150	60	1600	300	5.5	● ● ● ●	0034.3118
1.6	250	1)	150	60	1600	300	10.5	● ● ● ●	0034.3119
2	250	1)	150	60	1600	300	16	● ● ● ●	0034.3120

Rated Current [A]	Rated Voltage [VAC]	Breaking Capacity	Voltage Drop 1.0 I _n max. [mV]	Voltage Drop 1.0 I _n typ. [mV]	Power Dissipation 1.5 I _n max. [mW]	Power Dissipation 1.5 I _n typ. [mW]	Melting I ² t 10.0 Intyp. [A ² s]	     	Order Number
2.5	250	1)	120	60	1600	400	21.9	● ● ● ●	0034.3121
3.15	250	1)	100	60	1600	500	47	● ● ● ●	0034.3122
4	250	2)	100	60	1600	800	68.3	● ● ● ●	0034.3123
5	250	2)	100	60	1600	900	102	● ● ● ●	0034.3124
6.3	250	2)	100	60	1600	1000	190	● ● ● ●	0034.3125
8	250	2)	100	60	4000	1300	275	● ● ● ●	0034.3126
10	250	2)	100	60	4000	1300	520	● ● ● ●	0034.3127
12.5	250	2)	-	60	-	2500	750	● ● ● ●	0034.3128
16	250	2)	-	60	-	3300	1638	● ● ● ●	0034.3129
20	250	2)	-	60	-	4200	3057	● ● ● ●	0034.3130

Most Popular:

Availability for all products can be searched real-time: <http://www.schurter.com/Stock-Check/Stock-Check-SCHURTER>

1) 35 A @ 250 VAC

2) 10 x I_n @ 250 VAC

Packaging Unit	xxxx.xxxx xxxx.xxxx.G	Small Box Pack (10 pcs.) Bulk 128 x 91 x 60 mm (1000 pcs.)
----------------	--------------------------	---

勝特力材料 886-3-5753170
 勝特力电子(上海) 86-21-34970699
 勝特力电子(深圳) 86-755-83298787
[Http://www.100y.com.tw](http://www.100y.com.tw)