

# Electronic Fuses

## Section Contents

	Page
5 x 15mm ferrule fuses . . . . .	54
<b>5 x 20mm European (IEC) ferrule fuses . . . . .</b>	<b>55</b>
5 x 20mm North American (UL) ferrule fuses . . . . .	56
¼" Dia. x ½" to 1" length ferrule fuses . . . . .	57
¼" Dia. x 1¼" length fast-acting ferrule fuses . . . . .	58
¼" Dia. x 1¼" length time-delay ferrule fuses . . . . .	59
<b>PCB mount fuse holders . . . . .</b>	<b>60-61</b>
PCB fuseclips for 5mm dia. fuses . . . . .	62
PCB fuseclips for ¼" dia. fuses . . . . .	63
PCB fuseclips for 1 <sup>3</sup> / <sub>32</sub> " dia. and ATC® fuses . . . . .	64
PCB fuseclips for ¼", ⅜", 1 <sup>3</sup> / <sub>32</sub> " & ⅝" fuses . . . . .	65

**RED indicates NEW information**



**5 x 15mm ferrule fuses**

**C515 (axial leads)**

**C519**

**Specifications**  
**Description:**  
Time-delay fuse.

**Construction:**  
Glass tube.

**Ratings:**

- Volts — 125Vac (3.5-7A)
- 250Vac (125mA-3A)
- Amps — 125mA-7A
- IR — 35A (125mA-1A @ 250Vac, p.f. = 0.7-0.8)
- 10kA (125mA-3A @ 125Vac, p.f. = 0.7-0.8)
- 25A (350mA @ 600V, p.f. = 0.7-0.8)
- 100A (1.25-3A @ 250Vac, p.f. = 0.7-0.8)
- 400A (3.5-7A @ 125Vac, p.f. = 1.0)

**Agency Information:** CE, UL Listing File E19180, Guide JDYX 125mA-250mA and 375mA-3A CSA Certification File LR65063, Class 1422-01, 125mA-250mA and 375mA-3A, UL Recognized, File E19180, Guide JDYX2, 350mA and 3.5A-7A.

**Features and Benefits**

- Time-delay for closer sizing on inductive circuits.

**Typical Application**

- Electronic Circuits
- Printed Circuit Boards

**Catalog Numbers (Amps)**

**With Axial Leads**

C515-125-R	C515-750-R	C515-2.25-R
C515-250-R	C515-1-R	C515-3-R
C515-350-R	C515-1.25-R	C515-3.5-R
C515-375-R	C515-1.5-R	C515-4-R
C515-500-R	C515-1.6-R	C515-5-R
C515-600-R	C515-2-R	C515-7-R

**Without Axial Leads**

C519-125-R	C519-750-R	C519-2.25-R
C519-250-R	C519-1-R	C519-3-R
C519-350-R	C519-1.25-R	C519-3.5-R
C519-375-R	C519-1.5-R	C519-4-R
C519-500-R	C519-1.6-R	C519-5-R
C519-600-R	C519-2-R	C519-7-R

**Data Sheet: 2006 (C515) & 2007 (C519)**

**C518 (axial leads)**

**C520**

**Specifications**  
**Description:**  
Fast-acting fuse.

**Construction:**  
Glass tube.

**Ratings:**

- Volts — 250Vac
- Amps — 100mA-5A
- IR — 35A (100mA-750mA @ 250V, p.f. = 0.7-0.8)
- 10kA (100mA-5A @ 125V, p.f. = 0.7-0.8)
- 100A (1-3.5A @ 250V, p.f. = 0.7-0.8)
- 200A (4-5A @ 250V, p.f. = 0.7-0.8)

**Agency Information:** CE, UL Listing File E19180, Guide JDYX CSA Certification File LR65063, Class 1422-01.

**Features and Benefits**

- Small footprint saves space in equipment.
- Fast-acting for maximum component protection.
- Available in clip mount and solder-in configurations

**Typical Applications**

- Electronic Circuits
- Printed circuit Boards

**Catalog Numbers (Amps)**

**With Axial Leads**

C518-100-R	C518-750-R	C518-3-R
C518-125-R	C518-1-R	C518-3.5-R
C518-250-R	C518-1.5-R	C518-4-R
C518-375-R	C518-2-R	C518-5-R
C518-500-R	C518-2.5-R	

**Without Axial Leads**

C520-100-R	C520-750-R	C520-3-R
C520-125-R	C520-1-R	C520-3.5-R
C520-250-R	C520-1.5-R	C520-4-R
C520-375-R	C520-2-R	C520-5-R
C520-500-R	C520-2.5-R	

**Data Sheet: 2026 (C518) & 2027 (C520)**

**C517 (axial leads)**

**Specifications**

**Description:** Fast-acting fuse.

**Construction:** Glass tube.

**Ratings:**

- Volts — 350Vac\*
- Amps — 3A
- IR — 100A @ 350Vac, p.f. = 1.0
- 100A @ 250Vac, p.f. = 0.7-0.8
- 10kA @ 125Vac, p.f. = 0.7-0.8

\*350Vac/100A is UL Recognized

**Agency Information:** CE, UL Listing File E19180, Guide JDYX CSA Certification File LR65063, Class 1422-01 UL Recognized, File E19180, Guide JDYX2.

- Small footprint saves space in equipment.
- Fast-acting for maximum component protection.
- 350Vac rating for 277V ballast circuit protection.

**Typical Applications**

- Electronic Circuits
- Printed Circuit Boards
- Electronic Ballast Protection

**Catalog Number (Amps)**

**With Axial Leads**  
C517-3



**5 x 20mm European (IEC) ferrule fuses**

**S500-V (GDB-V) (axial leads)**

**S500 (GDB)**

**Specifications**

**Description:** Fast-acting, low-breaking capacity fuse.

**Construction:**

Glass tube, nickel-plated brass end-caps.

**Ratings:**

- Volts — 250Vac (or less)
- Amps — 32mA-16A
- IR — 35A @ 250Vac



**Agency Information:** CE, Designed to IEC 60127-Sheet II British Standard Approval SEMKO Approval VDE Approval, IMQ UL Recognized, Guide JDYX2, File E19180, 32mA-6.3A.

**Features and Benefits**

- Fast-acting for maximum protection, conforms to IEC standards.

**Typical Applications**

- Electronic Circuits

**Catalog Numbers (Amps)**

Catalog Numbers	i <sup>2</sup> t	Max Voltage Drop (mV)
S500-32	0.00047	1000
S500-40	0.0011	800
S500-50	0.0020	320
S500-63	0.0057	250
S500-80	0.012	220
S500-100	0.03	210
S500-125	0.05	200
S500-160	0.08	195
S500-200	0.16	160
S500-250	0.28	140
S500-315	0.58	115
S500-400	0.18	95
S500-500	0.18	220
S500-630	0.35	220
S500-800	0.67	180
S500-1	0.60	200
S500-1.25	0.84	200
S500-1.6	1.6	190
S500-2	4.2	160
S500-2.5	6.1	145
S500-3.15	13	130
S500-4	22	120
S500-5	42	115
S500-6.3	69	110
S500-8*	—	—
S500-10*	—	—
S500-12*	—	—
S500-16*	—	—

\*IEC Standard 127 Sheet II does not include ratings above 6.3A.

**Options**

Axial leads, put "V" in P/N, RoHS compliant, put "R" suffix in P/N. Example: S500-V-1.25-R.

**Data Sheet: 2015**

**S501-V (GDA-V) (axial leads)**

**S501 (GDA)**

**Specifications**

**Description:** Fast-acting, high-breaking capacity fuse.

**Construction:**

Ceramic tube, nickel-plated brass end-caps.

**Ratings:**

- Volts — 250Vac (or less)
- Amps — 50mA-6.3A
- IR — 1500A @ 250Vac



**Agency Information:** CE, UL Recognized, Guide JDYX2, File E19180, 50mA and 315mA-6.3A SEMKO Approval 50mA, 200mA and 315mA-6.3A, IEC 60127-Sheet I, VDE Approval 1.25A-6.3A.

**Features and Benefits**

- Fast-acting for maximum protection.
- High break capacity for use in higher fault energy electronic circuitry.
- Conforming to IEC standards.

**Typical Applications**

- Electronic Circuits

**Catalog Numbers (Amps)**

Catalog Numbers	i <sup>2</sup> t	Max Voltage Drop (mV)
S501-50	0.0017	9000
S501-63	0.0005	3300
S501-80	0.0011	2600
S501-100	0.0018	2300
S501-125	0.0037	1900
S501-160	0.008	1600
S501-200	0.020	1350
S501-250	0.027	1300
S501-315	0.010	1400
S501-400	0.018	1200
S501-500	0.038	1050
S501-630	0.064	1200
S501-800	0.097	490
S501-1	0.480	230
S501-1.25	0.9	200
S501-1.6	1.9	180
S501-2	2.0	205
S501-2.5	3.9	190
S501-3.15	8.1	160
S501-4	14	160
S501-5	25	155
S501-6.3	48	150

**Options**

Axial leads, put "V" in P/N, RoHS compliant, put "R" suffix in P/N. Example: S501-V-1.25-R.

**Data Sheet: 2014**

**S506-V (GDC-V) (axial leads)**

**S506 (GDC)**

**Specifications**

**Description:** Time-delay, low-breaking capacity fuse.

**Construction:**

Glass tube, nickel-plated brass end-caps.

**Ratings:**

- Volts — 250Vac (or less)
- Amps — 32mA-6.3A
- IR — 35A @ 250Vac



**Agency Information:** CE, Designed to IEC 60127-Sheet III British Standard Approval SEMKO Approval VDE Approval, IMQ UL Recognized, Guide JDYX2, File E19180, 32mA-6.3A.

**Features and Benefits**

- Time-delay compatibility for inductive circuits.
- Conforming to IEC standards.

**Typical Applications**

- Electronic Circuits

**Catalog Numbers (Amps)**

Catalog Numbers	i <sup>2</sup> t	Max Voltage Drop (mV)
S506-32	0.0014	1050
S506-40	0.0034	920
S506-50	0.006	800
S506-63	0.012	760
S506-80	0.015	580
S506-100	0.022	490
S506-125	0.034	390
S506-160	0.052	320
S506-200	0.078	340
S506-250	0.17	270
S506-315	0.41	250
S506-400	0.61	210
S506-500	0.75	168
S506-630	1.3	158
S506-800	3.1	132
S506-1	3.6	85
S506-1.25	7	80
S506-1.6	10	80
S506-2	17	80
S506-2.5	34	80
S506-3.15	56	75
S506-4	91	75
S506-5	133	75
S506-6.3	270	65

**Options**

Axial leads, put "V" in P/N, RoHS compliant, put "R" suffix in P/N. Example: S506-V-1.25-R.

**Data Sheet: 2016**

Electronic Fuses

**5 x 20mm North American (UL) ferrule fuses**

**GMA-V (axial leads)**

**GMA**

**Specifications**  
**Description:**  
Fast-acting fuse.

**Construction:**  
Glass tube,  
nickel-plated brass  
endcaps.

**Ratings:**

- Volts — 250Vac (63mA-2.5A)
- 125Vac (3.15-15A)
- Amps — 63mA-15A
- IR — 35A (63mA- 1A @ 250Vac, p.f. = 0.7-0.8)
- 10kA (63mA-6A @ 125Vac, p.f. = 0.7-0.8)
- 100A (1.25-2.5A @ 250Vac, p.f. = 0.7-0.8)
- 200A (7-8A @ 125Vac, p.f. = 1.0)
- 150A (10-15A @ 125Vac, p.f. = 1.0)

**Agency Information:** CE, Std. 248-14 UL Listed Guide JDYX, File E19180, 0-6A, UL Recognized, Guide JDYX2, File E19180, 7-15A, CSA Certified, Class 1422-01, File E65063, 0-6.

**Features and Benefits**

- Fast-acting for maximum protection.

**Typical Applications**

- Electronic Circuits

**Catalog Numbers (Amps)**

**With Axial Leads**

GMA-V-63-R	GMA-V-800-R	GMA-V-4-R
GMA-V-100-R	GMA-V-1-R	GMA-V-5-R
GMA-V-125-R	GMA-V-1.25-R	GMA-V-6-R
GMA-V-200-R	GMA-V-1.5-R	GMA-V-7-R
GMA-V-250-R	GMA-V-1.6-R	GMA-V-8-R
GMA-V-300-R	GMA-V-2-R	GMA-V-10-R
GMA-V-500-R	GMA-V-2.5-R	GMA-V-15-R
GMA-V-600-R	GMA-V-3.15-R	
GMA-V-750-R	GMA-V-3.5-R	

**Without Axial Leads**

GMA-63-R	GMA-800-R	GMA-4-R
GMA-100-R	GMA-1-R	GMA-5-R
GMA-125-R	GMA-1.25-R	GMA-6-R
GMA-200-R	GMA-1.5-R	GMA-7-R
GMA-250-R	GMA-1.6-R	GMA-8-R
GMA-300-R	GMA-2-R	GMA-10-R
GMA-500-R	GMA-2.5-R	GMA-15-R
GMA-600-R	GMA-3.15-R	
GMA-750-R	GMA-3.5-R	

Data Sheet: 2017

**GMC-V (axial leads)**

**GMC**

**Specifications**  
**Description:** Medium time-delay fuse.

**Construction:** Glass tube, nickel-plated brass endcaps.

**Ratings:**

- Volts — 250Vac (63mA-3.15A)
- 125Vac (3.5-10A)
- Amps — 63mA-10A
- IR — 35A (63mA- 1A @ 250Vac, p.f. = 0.7-0.8)
- 10kA (63mA-6A @ 125Vac, p.f. = 0.7-0.8)
- 100A (1.25-3.15A @ 250Vac, p.f. = 0.7-0.8)
- 200A (6.3-10A @ 125Vac, p.f. = 1.0)

**Agency Information:** CE, Std. 248-14, UL Listed Guide JDYX, File E19180, 0-6.3A, UL Recognized, Guide JDYX2, File E19180, 7-8A, CSA Certified, Class 1422-01, File 65063, 0-6.3A.

**Features and Benefits**

- Conforming to UL standards.

**Typical Applications**

- Electronic Circuits

**Catalog Numbers (Amps)**

**With Axial Leads**

GMC-V-63-R	GMC-V-500-R	GMC-V-2.5
GMC-V-80-R	GMC-V-600-R	GMC-V-3.15
GMC-V-100-R	GMC-V-630-R	GMC-V-3.5
GMC-V-125-R	GMC-V-750-R	GMC-V-4
GMC-V-150-R	GMC-V-800-R	GMC-V-5
GMC-V-200-R	GMC-V-1-R	GMC-V-6
GMC-V-250-R	GMC-V-1.25-R	GMC-V-6.3
GMC-V-300-R	GMC-V-1.5-R	GMC-V-7
GMC-V-315-R	GMC-V-1.6-R	GMC-V-8
GMC-V-400-R	GMC-V-2-R	GMC-V-10

**Without Axial Leads**

GMC-63mA	GMC-500-R	GMC-2.5-R
GMC-80mA	GMC-600-R	GMC-3.15-R
GMC-100mA	GMC-630-R	GMC-3.5-R
GMC-125mA	GMC-750-R	GMC-4-R
GMC-150mA	GMC-800-R	GMC-5-R
GMC-200mA	GMC-1-R	GMC-6-R
GMC-250mA	GMC-1.25-R	GMC-6.3-R
GMC-300mA	GMC-1.5-R	GMC-7-R
GMC-315mA	GMC-1.6-R	GMC-8-R
GMC-400mA	GMC-2-R	GMC-10-R

Data Sheet: 2018

**GMD-V (axial leads)**

**GMD**

**Specifications**  
**Description:** Time-delay fuse.

**Construction:** Glass tube, nickel-plated brass endcaps.

**Ratings:**

- Volts — 250Vac
- Amps — 125mA-4A
- IR — 10kA (125mA-3A @ 125Vac, p.f. = 0.7-0.8)
- 10kA (4A @ 125Vac, p.f. = 1.0)
- 100A (125mA-3.A @ 250Vac, p.f. = 0.7-0.8)
- 200A (4A @ 250Vac, p.f. = 1.0)

**Agency Information:** CE, Std. 248-14, UL Listed Guide JDYX, File E19180, 0-3A, UL Recognized, Guide JDYX2, File E19180, 4A, CSA Certified, Class 1422-01, File 65063, 0-3A.

**Features and Benefits**

- Time-delay compatibility for inductive circuits.
- Conforming to UL standards.

**Typical Applications**

- Electronic Circuits

**Catalog Numbers (Amps)**

**With Axial Leads**

GMD-V-125-R	GMD-V-500-R	GMD-V-1.5-R
GMD-V-150-R	GMD-V-630-R	GMD-V-1.6-R
GMD-V-200-R	GMD-V-750-R	GMD-V-2-R
GMD-V-250-R	GMD-V-800-R	GMD-V-2.5-R
GMD-V-300-R	GMD-V-1-R	GMD-V-3-R
GMD-V-315-R	GMD-V-1.2-R	GMD-V-4-R
GMD-V-400-R	GMD-V-1.25-R	

**Without Axial Leads**

GMD-125-R	GMD-500-R	GMD-1.5-R
GMD-150-R	GMD-630-R	GMD-1.6-R
GMD-200-R	GMD-750-R	GMD-2-R
GMD-250-R	GMD-800-R	GMD-2.5-R
GMD-300-R	GMD-1-R	GMD-3-R
GMD-315-R	GMD-1.2-R	GMD-4-R
GMD-400-R	GMD-1.25-R	

Data Sheet: 2019

**Electronic — PCB & Small Dimension Fuses**

**¼" Dia. x ⅝" to 1" length ferrule fuses**

**AGA-V (axial leads)**

**AGA**

**Specifications**  
**Description:** Fast-acting fuse.

**Dimensions:**  
¼" x ⅝"  
(6.4 x 15.9mm).

**Construction:**  
Glass tube.

**Ratings:**  
Volts — 125Vac (or less)  
Amps — ⅙-30A

IR — 10,000 (⅙-1½A @ 125Vac)  
— 200A (2-5A @ 125Vac)  
— 1000A (6-30A @ 32Vac)

**Agency Information:** CE, Std. 248-14, UL File E19180, UL Listed, Guide JDYX 0-1½A UL Recognized, Guide JDYX2 2-12A.

**Features and Benefits**

- Fast-acting for maximum protection.
- Size rejects insertion of other fuse types.

**Typical Applications**

- Electronic Circuits

**Catalog Numbers (Amps) With Axial Leads\***

AGA-V-⅙	AGA-V-1	AGA-V-7 ½
AGA-V-⅓	AGA-V-1 ½	AGA-V-10
AGA-V-½	AGA-V-2	AGA-V-15
AGA-V-¾	AGA-V-2 ½	AGA-V-20
AGA-V-1	AGA-V-3	AGA-V-25
AGA-V-1 ½	AGA-V-5	AGA-V-30
AGA-V-2	AGA-V-6	
AGA-V-3	AGA-V-7	

**Without Axial Leads**

AGA-⅙	AGA-1	AGA-7 ½
AGA-⅓	AGA-1 ½	AGA-10
AGA-½	AGA-2	AGA-15
AGA-¾	AGA-2 ½	AGA-20
AGA-1	AGA-3	AGA-25
AGA-1 ½	AGA-5	AGA-30
AGA-2	AGA-6	
AGA-3	AGA-7	

\*AGA-V is UL Listed 0-5A, UL Recognized 6-12A.



**AGW**

**Specifications**  
**Description:** Fast-acting fuse.

**Dimensions:** ¼" x ⅝"  
(6.4 x 22.2mm).

**Construction:** Glass tube.

**Ratings:**  
Volts — 32Vac  
Amps — 1-30A  
IR — 100A

**Features and Benefits**

- Fast-acting for maximum protection.
- Size rejects insertion of other fuse types.

**Typical Applications**

- Electronic Circuits

**Catalog Numbers (Amps)**

AGW-1	AGW-4	AGW-15
AGW-1 ½	AGW-5	AGW-20
AGW-2	AGW-6	AGW-25
AGW-2 ½	AGW-7 ½	AGW-30
AGW-3	AGW-10	



**AGX-V (axial leads)**

**AGX**

**Specifications**  
**Description:** Fast-acting fuse.

**Dimensions:** ¼" x 1"  
(6.4 x 25.4mm).

**Construction:** Glass tube.

**Ratings:**  
Volts — 250Vac (⅙-2A)  
— 125Vac (2½-7A)  
— 32V (8-30A)

Amps — ⅙-30A  
IR — 35A (⅙-2A @ 250Vac)  
— 10,000A (2½-7A @ 125Vac)  
— 1000A (8-30A @ 32V)

**Agency Information:** CE, Std. 248-14, UL File E19180 UL Listed, Guide JDYX, 0-5A UL Recognized, Guide JDYX2, 6-20A CSA File 47233; Class 1422-01, 0-5A.

**Features and Benefits**

- Size rejects insertion of other fuse types.

**Typical Applications**

- Electronic Circuits

**Catalog Numbers (Amps) With Axial Leads\*\***

AGX-V-⅙	AGX-V-⅓	AGX-V-5
AGX-V-⅓	AGX-V-⅙	AGX-V-6
AGX-V-⅓	AGX-V-½	AGX-V-7
AGX-V-⅓	AGX-V-¾	AGX-V-8
AGX-V-⅓	AGX-V-1	AGX-V-10
AGX-V-⅓	AGX-V-1 ½	AGX-V-15
AGX-V-⅓	AGX-V-1 ½	AGX-V-20
AGX-V-⅓	AGX-V-2	AGX-V-25
AGX-V-⅓	AGX-V-2 ½	AGX-V-30
AGX-V-⅓	AGX-V-3	
AGX-V-⅓	AGX-V-4	

**Without Axial Leads**

AGX-⅙	AGX-⅓	AGX-5
AGX-⅓	AGX-⅙	AGX-6
AGX-⅓	AGX-½	AGX-7
AGX-⅓	AGX-¾	AGX-8
AGX-⅓	AGX-1	AGX-10
AGX-⅓	AGX-1 ½	AGX-15
AGX-⅓	AGX-1 ½	AGX-20
AGX-⅓	AGX-2	AGX-25
AGX-⅓	AGX-2 ½	AGX-30
AGX-⅓	AGX-3	
AGX-⅓	AGX-4	

\*\*AGX-V is UL Recognized from 6-20A @ 32Vac



Electronic Fuses

**Electronic — PCB & Small Dimension Fuses**

**1/4" Dia. x 1 1/4" length fast-acting ferrule fuses**

**AGC-V (axial leads)**

**AGC**

**Specifications**

**Description:** Fast-acting fuse.

**Dimensions:** 1/4" x 1 1/4"  
(6.4 x 31.7mm).

**Construction:** Glass tube with nickel-plated brass endcaps.

**Ratings:**

Volts — 250Vac (1/20-10A)  
— 32Vac (11-45A)

Amps — 1/20-30A

IR\* — 35A (1/20-1A @ 250Vac)  
— 100A (1 1/4-3A @ 250Vac)  
— 200A (4-10A @ 250Vac)  
— 1000A (15-30A @ 32Vac)

\*Interrupting ratings were measured at 70% – 80% power factor on AC, and at a time constant described in UL 248.

**Agency Information:** CE, Std. 248-14, UL Listed, Guide JDYX, File E19180, 0-10A UL Recognized, Guide JDYX2, File E19180, 15-30A CSA Certification, Class 1422-01, File 53787.

**Features and Benefits**

- Original electronic glass tube fuse.
- Fast-acting for maximum protection.
- Wide amp/volt ratings allow versatility of protecting electronic circuits.

**Typical Applications**

- Electronic Circuits

**Catalog Numbers (Amps)**

**With Axial Leads**

AGC-V-1/20	AGC-V-1/2	AGC-V-5
AGC-V-1/10	AGC-V-3/4	AGC-V-6
AGC-V-1/10	AGC-V-1	AGC-V-7
AGC-V-1/8	AGC-V-1 1/4	AGC-V-8
AGC-V-3/10	AGC-V-1 1/2	AGC-V-9
AGC-V-3/10	AGC-V-2	AGC-V-10
AGC-V-1/4	AGC-V-2 1/4	AGC-V-15
AGC-V-3/10	AGC-V-2 1/2	AGC-V-20
AGC-V-3/8	AGC-V-3	AGC-V-25
AGC-V-4/100	AGC-V-4	AGC-V-30

**Without Axial Leads**

AGC-1/20	AGC-1/2	AGC-5
AGC-1/10	AGC-3/4	AGC-6
AGC-1/10	AGC-1	AGC-7
AGC-1/8	AGC-1 1/4	AGC-8
AGC-3/10	AGC-1 1/2	AGC-9
AGC-1/4	AGC-2	AGC-10
AGC-3/10	AGC-2 1/4	AGC-15
AGC-3/10	AGC-2 1/2	AGC-20
AGC-3/8	AGC-3	AGC-25
AGC-4/100	AGC-4	AGC-30

Data Sheet: 2001

**ABC-V (axial leads)**

**ABC**

**Specifications**

**Description:** Fast-acting fuse.

**Dimensions:** 1/4" x 1 1/4"  
(6.4 x 31.7mm).

**Construction:** Ceramic tube with nickel-plated brass endcaps.

**Ratings:**

Volts — 250Vac/125Vdc (1/4-20A)  
— 125Vac/125Vdc (25-30A)

Amps — 1/4-30A

IR\*\* — 35A (1/4-1A @ 250Vac)  
— 10kA (1/4-20A @ 250Vdc)  
— 100A (1 1/2-3A @ 250Vac)  
— 200A (4-10A @ 250Vac)  
— 750A (15A @ 250Vac)  
— 400A (20A @ 250Vac)  
— 400A (25-30A @ 250Vdc)  
— 1kA (25-30A @ 125Vac)

\*\*Interrupting ratings were measured at 70% – 80% power factor on AC, and at a time constant described in UL 248.

**Agency Information:** CE, Std. 248-14 UL Listed, Guide JDYX File E19180, 0-15A UL Recognized, Guide JDYX2, File E19180, 20-25A CSA Certification, Class 1422-01, File 53787, 0-15A, Class 1422-30, File 53787, 20-25A.

**Features and Benefits**

- Ceramic body allows for higher amp/volt rating combinations.
- Consolidate inventory by replacing AGC fuses for reduced SKU investment and minimizing potential for misapplying fuse.

**Typical Applications**

- Electronic Circuits

**Catalog Numbers (Amps)**

**With Axial Leads**

ABC-V-1/4	ABC-V-2 1/2	ABC-V-8
ABC-V-1/2	ABC-V-3	ABC-V-10
ABC-V-3/4	ABC-V-4	ABC-V-15
ABC-V-1	ABC-V-5	ABC-V-20
ABC-V-1 1/2	ABC-V-6	ABC-V-25
ABC-V-2	ABC-V-7	ABC-V-30

**Without Axial Leads**

ABC-1/4	ABC-2 1/2	ABC-8
ABC-1/2	ABC-3	ABC-10
ABC-3/4	ABC-4	ABC-15
ABC-1	ABC-5	ABC-20
ABC-1 1/2	ABC-6	ABC-25
ABC-2	ABC-7	ABC-30

Data Sheet: 2000

**GBB-V (axial leads)**

**GBB**

**Specifications**

**Description:** Very fast-acting fuse.

**Dimensions:** 1/4" x 1 1/4"  
(6.4 x 31.7mm).

**Construction:** Ceramic cartridge with nickel-plated brass endcaps.

**Ratings:**

Volts — 250Vac/125Vdc  
Amps — 1-30A  
IR — 200A @ 250Vac  
— 200A (20-30A @ 125Vac/dc)  
— 10,000A (1A -15A @ 125Vac/dc)

**Agency Information:** CE, Std. 248-14, UL Recognized, 1-30, 125Vdc/250Vac, File E56412, Guide JFHR2, CSA Certified, 1-10, 125Vdc/250Vac, File 53787, Class 1422-01.

**Features and Benefits**

- Very fast-acting performance allows protection of highly sensitive electronic circuitry.

**Typical Applications**

- Electronic Circuits

**Catalog Numbers (Amps)**

**With Axial Leads**

GBB-V-1	GBB-V-6	GBB-V-15
GBB-V-1 1/4	GBB-V-7	GBB-V-20
GBB-V-2	GBB-V-8	GBB-V-25
GBB-V-3	GBB-V-9	GBB-V-30
GBB-V-4	GBB-V-10	
GBB-V-5	GBB-V-12	

**Without Axial Leads**

GBB-1	GBB-6	GBB-15
GBB-1 1/4	GBB-7	GBB-20
GBB-2	GBB-8	GBB-25
GBB-3	GBB-9	GBB-30
GBB-4	GBB-10	
GBB-5	GBB-12	

Data Sheet: 2013

1/4" Dia. x 1 1/4" length time-delay ferrule fuses

**MDL-V (axial leads)**

**MDL**

**Specifications**  
**Description:** Time-delay fuse.

**Dimensions:** 1/4" x 1 1/4"  
(6.4 x 31.7mm).

**Construction:** Glass tube with nickel-plated brass endcaps.

**Ratings:**

- Volts — 250Vac (1/6-8A)
- 32Vac (9-30A)
- Amps — 1/6-30A
- IR\* — 35A (1/6-1A @ 250Vac)
- 100A (1 1/4-3A @ 250Vac)
- 200A (4-8A @ 250Vac)
- 1000A (9-30A @ 32Vac)

\*Interrupting ratings were measured at 70% – 80% power factor on ac, and at a time constant described in UL 198L.

**Agency Information:** CE, Std. 248-14, UL Listed, Guide JDYX, File E19180; 1/6-8A CSA Certification Class 1422-01, File 53787, 1/6-8A, UL Recognized, Guide JDYX2, File E19180, 8.1-30A.

**Features and Benefits**

- Time-delay allows close sizing on inductive circuits.
- Broad amp size range allows improved compatibility between fuse and circuit operating characteristics.

**Typical Applications**

- Electronic Circuits

**Catalog Numbers (Amps)**

**With Axial Leads**

MDL-V-1/6	MDL-V-1	MDL-V-7
MDL-V-1/10	MDL-V-1 1/4	MDL-V-8
MDL-V-1/6	MDL-V-1 1/2	MDL-V-9
MDL-V-1/10	MDL-V-2	MDL-V-10
MDL-V-1/6	MDL-V-2 1/4	MDL-V-12
MDL-V-1/4	MDL-V-2 1/2	MDL-V-15
MDL-V-1/10	MDL-V-3	MDL-V-20
MDL-V-1/6	MDL-V-4	MDL-V-25
MDL-V-1/2	MDL-V-5	MDL-V-30
MDL-V-1/4	MDL-V-6	

**Without Axial Leads**

MDL-V-1/6	MDL-1	MDL-7
MDL-V-1/10	MDL-1 1/4	MDL-8
MDL-V-1/6	MDL-1 1/2	MDL-9
MDL-V-1/10	MDL-2	MDL-10
MDL-V-1/6	MDL-2 1/4	MDL-12
MDL-V-1/4	MDL-2 1/2	MDL-15
MDL-V-1/10	MDL-3	MDL-20
MDL-V-1/6	MDL-4	MDL-25
MDL-V-1/2	MDL-5	MDL-30
MDL-V-1/4	MDL-6	

Data Sheet:2004

**MDQ-V (axial leads)**

**MDQ**

**Specifications**  
**Description:** Dual-element, time-delay fuse.

**Dimensions:** 1/4" x 1 1/4"  
(6.4 x 31.7mm).

**Construction:** Glass tube with nickel-plated brass endcaps.

**Ratings:**

- Volts — 250Vac (1/100-7A)
- 32Vac (7 1/2-15A)
- Amps — 1/100-15A
- IR — 35A (1/100-1A @ 250Vac)
- 100A (1 1/4-3A @ 250Vac)
- 200A (4-7A @ 250Vac)
- 1000A (7 1/2-12A @ 32Vac)

**Agency Information:** CE, Std. 248-14, UL Listed, File E19180; Guide JDYX, 1/6-7A CSA Certification, File 47233, Class 1422-01, 1/6-7A, UL Recognized, Guide JDYX2, File E19180, 7.1-30A.

**Features and Benefits**

- Dual-element design allows closer sizing to inductive circuits than any other fuses.

**Typical Applications**

- Electronic Relay and Control Circuits

**Catalog Numbers (Amps)**

**With Axial Leads**

MDQ-V-1/100	MDQ-V-1/6	MDQ-V-1 1/2	MDQ-V-5
MDQ-V-1/50	MDQ-V-1/3	MDQ-V-1 3/4	MDQ-V-6
MDQ-V-1/10	MDQ-V-1/2	MDQ-V-1 9/10	MDQ-V-6 1/2
MDQ-V-1/6	MDQ-V-1/2	MDQ-V-1 1/10	MDQ-V-6 3/4
MDQ-V-1/10	MDQ-V-1/2	MDQ-V-2	MDQ-V-7
MDQ-V-1/6	MDQ-V-1/2	MDQ-V-2 1/4	MDQ-V-7 1/2
MDQ-V-1/100	MDQ-V-1/2	MDQ-V-2 1/2	MDQ-V-8
MDQ-V-1/1000	MDQ-V-1/2	MDQ-V-2 3/4	MDQ-V-9
MDQ-V-1/6	MDQ-V-1	MDQ-V-3	MDQ-V-10
MDQ-V-1/10	MDQ-V-1 1/10	MDQ-V-3 1/10	MDQ-V-12
MDQ-V-1/4	MDQ-V-1 1/2	MDQ-V-4	MDQ-15

**Without Axial Leads**

MDQ-1/100	MDQ-1/6	MDQ-1 1/2	MDQ-5
MDQ-1/50	MDQ-1/3	MDQ-1 3/4	MDQ-6
MDQ-1/10	MDQ-1/2	MDQ-1 9/10	MDQ-6 1/2
MDQ-1/6	MDQ-1/2	MDQ-2	MDQ-7
MDQ-1/10	MDQ-1/2	MDQ-2 1/4	MDQ-7 1/2
MDQ-1/100	MDQ-1/2	MDQ-2 1/2	MDQ-8
MDQ-1/1000	MDQ-1/2	MDQ-2 3/4	MDQ-9
MDQ-1/6	MDQ-1	MDQ-3	MDQ-10
MDQ-1/10	MDQ-1 1/10	MDQ-3 1/10	MDQ-12
MDQ-1/4	MDQ-1 1/2	MDQ-4	MDQ-15

Data Sheet: 2044

**MDA-V (axial leads)**

**MDA**

**Specifications**  
**Description:** Time-delay fuse.

**Dimensions:** 1/4" x 1 1/4"  
(6.4 x 31.7mm).

**Construction:** Ceramic tube with nickel-plated brass endcaps.

**Ratings:**

- Volts — 250Vac (or less)
- 125Vdc (20A- 30A)
- Amps — 1/10-30A
- IR\*\* — 35A (1/10-1A @ 250Vac)
- 100A (2 1/2-3A @ 250Vac)
- 200A (4-10A @ 250Vac)
- 1500A (15-30A @ 250Vac)
- 10,000A (20-30A @ 125Vdc)

\*\*Interrupting ratings were measured at 70% – 80% power factor on ac, and at a time constant described in UL 248.

**Agency Information:** CE, Std. 248-14, UL Listed, Guide JDYX, File E19180, 0-15A CSA Certification, Class 1422-01, File 53787, 0-15A.

**Features and Benefits**

- Ceramic body allows for higher amp/volt rating combinations.
- Inventory consolidation by replacing MDL fuses allows for reduced SKU investment and minimizing potential for misapplying fuse.

**Typical Applications**

- Electronic Circuits

**Catalog Numbers (Amps)**

**With Axial Leads**

MDA-V-1/10	MDA-V-2 1/2	MDA-V-10
MDA-V-1/6	MDA-V-3	MDA-V-12
MDA-V-1/2	MDA-V-4	MDA-V-15
MDA-V-1/3	MDA-V-5	MDA-V-20
MDA-V-1	MDA-V-6	MDA-V-25
MDA-V-1 1/2	MDA-V-7	MDA-V-30
MDA-V-2	MDA-V-8	

**Without Axial Leads**

MDA-1/10	MDA-2 1/2	MDA-10
MDA-1/6	MDA-3	MDA-12
MDA-1/2	MDA-4	MDA-15
MDA-1/3	MDA-5	MDA-20
MDA-1	MDA-6	MDA-25A
MDA-1 1/2	MDA-7	MDA-30A
MDA-2	MDA-8	

Data Sheet: 2002

Electronic  
Fuses

**PC board mount fuse holders**

**HTC-45M**



**PCB Vertical Mount**

**Specifications**

**Description:** PCB vertical mount bayonet cap and fuse holder.

**Dimensions:** See Dimensions illustration.

**Ratings:**

See Specifications table.

**Dimensions**

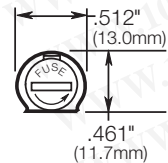
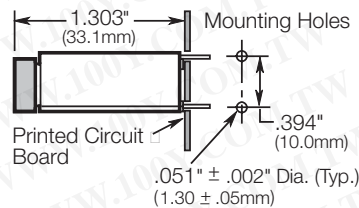

**RoHS  
2002/95/EC**

Data Sheet 2110

**HTC-50M**



**PCB Horizontal Mount**

**Specifications**

**Description:** PCB horizontal mount bayonet cap and fuse holder.

**Dimensions:** See Dimensions illustration.

**Ratings:**

See Specifications table.

**Dimensions**

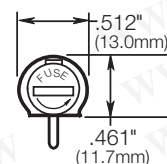
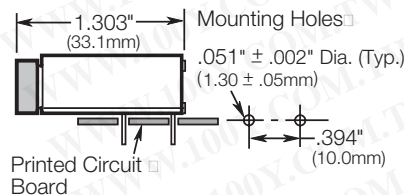

**RoHS  
2002/95/EC**

Data Sheet 2110

**HTC-60M, HTC-65M**



**PCB Stand-Off Mount**

**Specifications**

**Description:** Two-leg (HTC-60M) and four-leg (HTC-65M) PCB stand-off fuse holder.

**Dimensions:** See Dimensions illustration.

**Construction:** Valox DR48 body material, phosphor bronze terminals.

**Ratings:**

Volts: — 250V

Amps: — 6.3A

**Dimensions**

**HTC-60M  
(2-leg)**

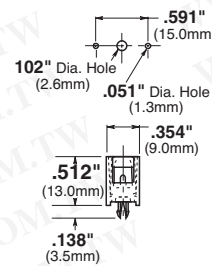

**HTC-65M  
(4-Leg)**

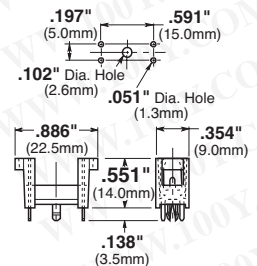

**RoHS  
2002/95/EC**

Data Sheet 2110

**Specifications**

Volts: 250V

Amps: 6.3A

Terminals: For HTC-45M, HTC-50M Tin-plated.

Molded Materials: High temperature thermoplastic that meets the flammability ratings of UL 94V0; Glow Wire Test: 960°C per IEC 60695-2-1.

Solderability: In accordance with IEC 68-2-20.

Electrical: Contact Resistance: ≤ 10mΩ; Insulation Resistance: ≥ 10mΩ; Dielectric Strength ≥ 2000 Vac.

Shock Safety: PC2 (fuse holders).

Agency Information: CE, HTC-45M, HTC-50M UL Recognized, (Guide IZLT2, File E14853; 6.3A, 250V; CSA Certified, (Class 6225-01, File 47235; 6.3A, 250V) SEMKO: (9226032; 6.3A, 250V).

Packaging: Standard Qty 10 (No Prefix), Bulk Qty 100 (Prefix Catalog Number with BK).



**PC board mount fuse holders**

**HBH-I (for ¼" x 1¼" fuses)**

**HBH-M (for 5 x 20mm fuses)**

**PCB Horizontal Mount**

**Specifications**  
**Description:** PCB horizontal mount fuse holder.

**Dimensions:** See Dimensions illustration.

**Ratings:**  
 See Specifications table.

**Dimensions**

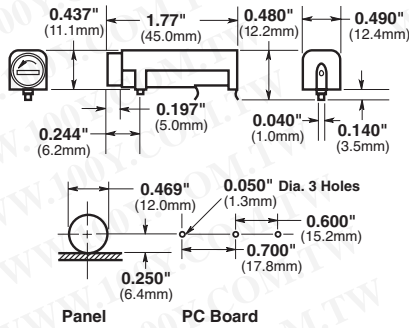

**Data Sheet: 2118**

**HBV-I (for ¼" x 1¼" fuses)**

**HBV-M (for 5 x 20mm fuses)**

**PCB Vertical Mount with Stability Pins**

**Specifications**  
**Description:** PCB vertical mount fuse holder with stability pins.

**Dimensions:** See Dimensions illustration.

**Ratings:**  
 See Specifications table.

**Dimensions**

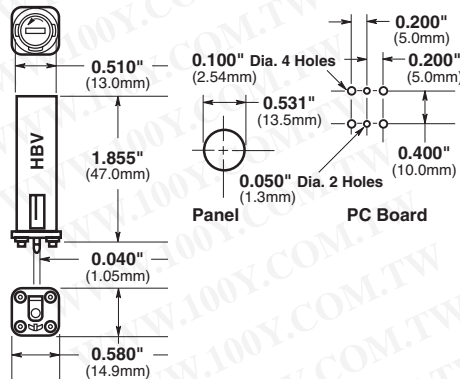

**Data Sheet: 2118**

**HBW-I (for ¼" x 1¼" fuses)**

**HBW-M (for 5 x 20mm fuses)**

**PCB Vertical Mount without Stability Pins**

**Specifications**  
**Description:** PCB vertical mount fuse holder without stability pins.

**Dimensions:** See Dimensions illustration.

**Ratings:**  
 See Specifications table.

**Dimensions**

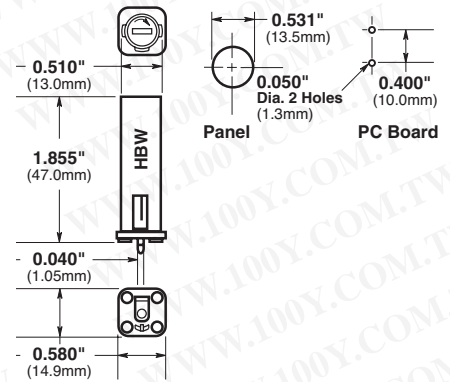

**Data Sheet: 2118**

Electronic Fuses



**FBI**



**FBM**

**Fuse Holder Caps (Fit all three shown above)**

**Specifications**

**Electrical Ratings:** UL — 16A @ 250V; CSA — 12A @ 250V; VDE — 6.3A @ 250V; SEMKO — 10A @ 250V  
 Insulation resistance — 10,000 megohm at 500Vdc. Contact resistance — less than 0.005 ohms @ 20mV. Dielectric strength — over 200V/mil.

**Molded Material:** High dielectric molded phenolic with a UL 94VO flammability rating.

**Fuse Carrier & Knob:** Spring-loaded, bayonet-type. Tin plated brass. Screwdriver slotted.

**Mounting:** "Kicked" terminals (all models) and stabilizer pins on HBV model for increased stability.

**Environmental:** Maximum operating temperature — (-40°C to +85°C).

**Agency Information:** CE, UL Recognized — Guide IZLT2, File EI4853;  
 CSA Certified — Class 6225-01, File 47235  
 VDE — 41421  
 SEMKO — 9308147 (HBH, HBV) 9222106 (HBW)

**Electronic — PCB & Small Dimension Fuses**

**PC board fuseclips for 5mm diameter fuses**

**HTC-15M, HTC-140M**

**PCB Mounted Fuse Holder & Snap-On Cover**

Voltage Rating: 250V, 6.3A, 1.6W

HTC-15M (fuse holder), HTC-140M (natural cover),  
HTC-150M\* (transparent cover)

\*Available in bulk only. Use this format: BK/HTC-150M  
**Data Sheet: 2110**

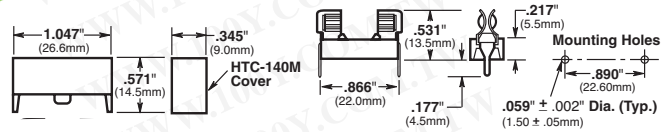

**HTC-200M**

**PCB Mounted Fuseclip**

Construction: Tin-plated bronze

Tape and Fan Fold packed

Ammo Pack (AP/HTC-200M) 1000 pieces per box  
**Data Sheet: 2110**

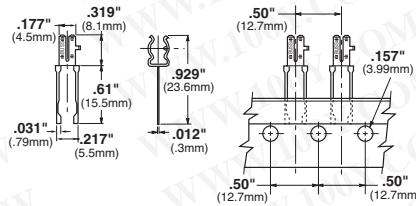

**HTC-210M**

**PCB Mounted Fuseclip with End Stops**

**Data Sheet: 2110**

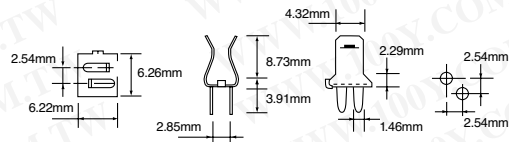

**1A3399 Series**

**PCB Fuseclips with End Stops & Straight Leads**

Catalog Numbers	Clip Material*	Finish
1A3399-01	Beryllium copper*	Silver
1A3399-04	Beryllium copper*	Bright tin
1A3399-10	Spring bronze	Bright tin

\*Beryllium copper recommended for amps higher than 15 amps (1/2" clips).  
**Data Sheet: 2131**

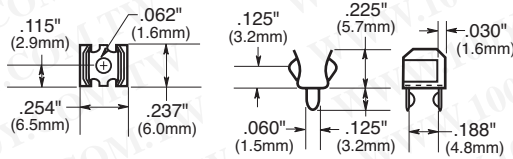

**1A5018 Series**

**PCB High Profile Fuseclips with End Stops & Straight Leads**

Catalog Numbers	Clip Material*	Finish
1A5018-7	Spring bronze	Silver
1A5018-10	Spring bronze	Bright tin

\*Beryllium copper recommended for amps higher than 15 amps (1/2" clips).  
**Data Sheet: 2131**

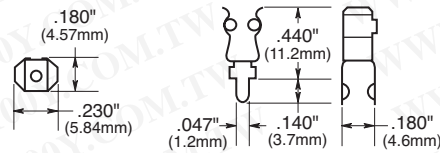

**1A5601 Series**

**PCB Fuseclips (0-7A)**

Catalog Number	Clip Material	Finish
1A5601	Cartridge brass	Bright tin

**Data Sheet: 2131**

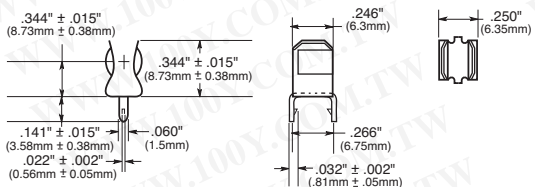

**1A5602 Series**

**PCB Fuseclips (0-7A)**

Catalog Number	Clip Material	Finish
1A5602	Cartridge brass	Bright tin

**Data Sheet: 2131**

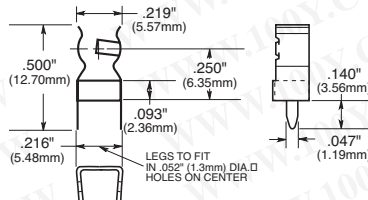

**Electronic — PCB & Small Dimension Fuses**

**PC board fuseclips for 1/4" diameter fuses**

**1A3398 Series**

**PCB Fuseclips without End Stops or Straight Leads**

Catalog Numbers	Clip Material	Finish
1A3398-07	Cartridge brass	Bright tin
1A3398-08	Spring bronze	Bright tin

**Data Sheet: 2131**

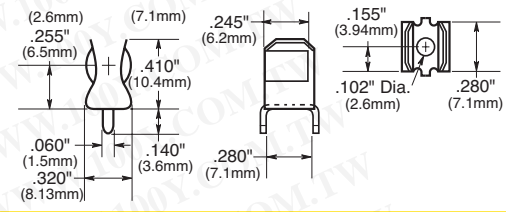

**1A1907 Series**

**PCB Fuseclips with End Stops & Straight Leads**

Catalog Numbers	Clip Material*	Finish
1A1907-02	Cartridge brass	None/bright dipped
1A1907-03	Beryllium copper*	Bright tin
1A1907-05	Beryllium copper*	Silver
1A1907-06	Cartridge brass	Bright tin
1A1907-08	Spring bronze	None/bright dipped
1A1907-09	Spring bronze	Bright tin

\*Beryllium copper recommended for amps higher than 15A (1/2" clips).

**Data Sheet: 2131**

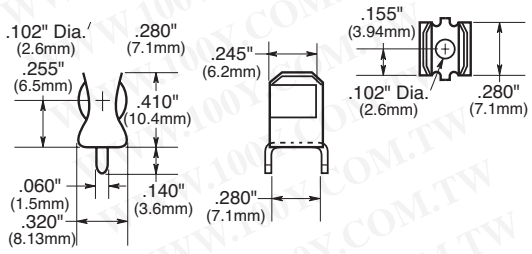

**1A4533 Series**

**PCB Fuseclips without End Stops or Angled Out Leads**

Catalog Numbers	Clip Material*	Finish
1A4533-01	Beryllium copper*	Bright tin
1A4533-06	Cartridge brass	Bright tin
1A4533-07	Spring bronze	Bright tin

\*Beryllium copper recommended for amps higher than 15A (1/2" clips).

**Data Sheet: 2131**

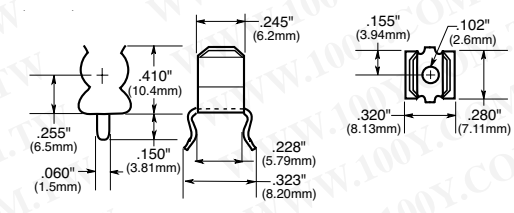

**1A4534 Series**

**PCB Fuseclips with End Stops & Angled Out Leads**

Catalog Numbers	Clip Material*	Finish
1A4534-01	Beryllium copper*	Bright tin
1A4534-06	Cartridge brass	Bright tin
1A4534-07	Spring bronze	Bright tin

\*Beryllium copper recommended for amps higher than 15A (1/2" clips).

**Data Sheet: 2131**

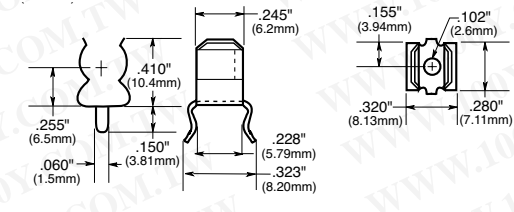

**1A1119 Series**

**Fuseclips with End Stops & Angled In Leads**

Catalog Numbers	Clip Material*	Finish
1A1119-04	Beryllium copper*	Bright tin
1A1119-05	Beryllium copper*	Silver
1A1119-10	Cartridge brass	Bright tin
1A1119-13	Spring bronze	Bright tin

\*Beryllium copper recommended for amps higher than 15A (1/2" clips).

**Data Sheet: 2131**

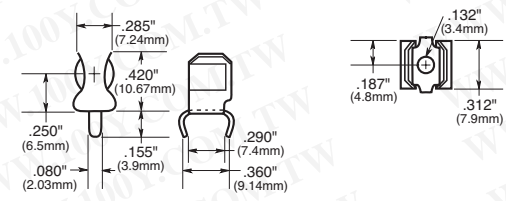

**1A1120 Series**

**PCB Fuseclips without End Stops or Angled In Leads**

Catalog Numbers	Clip Material*	Finish
1A1120-02	Cartridge brass	None/bright dipped
1A1120-05	Beryllium copper*	Silver
1A1120-06	Beryllium copper*	Bright tin
1A1120-09	Cartridge brass	Bright tin
1A1120-11	Spring bronze	None/bright dipped
1A1120-12	Spring bronze	Bright tin

\*Beryllium copper recommended for amps higher than 15A (1/2" clips).

**Data Sheet: 2131**

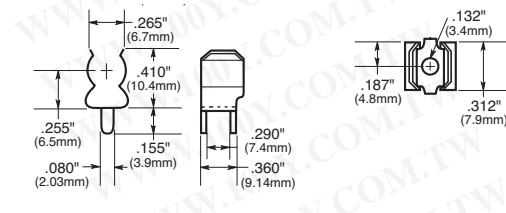

Electronic  
Fuses

**PC Board fuseclips for 1<sup>3</sup>/<sub>32</sub>" diameter and ATC® fuses**

**1A3400 Series**

PCB Fuseclips for 1<sup>3</sup>/<sub>32</sub>" diameter fuses with End Stops & Straight Leads

Catalog Number	Amp Rating	Clip Material	Finish
1A3400-09	20A Max.	Spring bronze	Bright tin

**Data Sheet 2131**

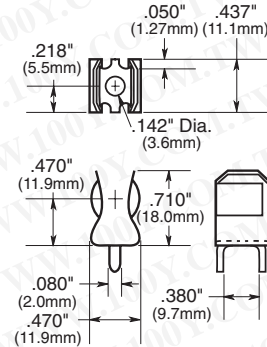

**1A5600 Series**

PCB Fuseclips for ATC® Fuses (0-20A)

Catalog Number	Clip Material	Finish
1A5600	Brass	Satin finish tin

**Data Sheet 2131**

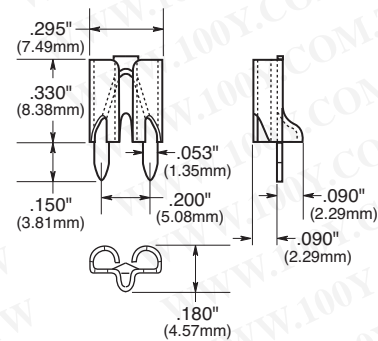

**Did You Know?**

**The POWER of Cooper Bussmann® Branded Merchandising**

The Cooper Bussmann brand name is recognized as the leader in circuit protection products by the majority of electrical end-users. Just like our circuit protection products, our branded merchandise is the highest quality. You can now find everything you need, from apparel to sporting goods at [www.BussShop.com](http://www.BussShop.com).

Shopping on-line will also give you:

- Up-to-date inventory counts
- Seasonally updated merchandise
- Immediate e-mail order acknowledgment and shipping notification
- Buss®Shop special pricing on sale items

**PC Board fuseclips for 1/4", 3/32", 13/32" and 9/16" diameter fuses**

**5681 & 5682 Series**

**PCB Fuseclips with Mounting Holes For 1/4" Diameter Fuses**

**Catalog Numbers**

Catalog Numbers	End Stop	Clip Mat.**	Finish	Dimensions (in)				Hole Dia.	Fig. Ref.
				B (To End Stop)	C (Contact)	D (Height)	E (Width)		
5681-08	No	Spg. Br.	Nickel	†	0.265	0.410	0.320	0.132	2
5681-15		Spg. Br.	Bright tin						
5682-01		BeCU	Silver	0.106					
5682-02	Yes	BeCU	Silver	0.132					
5682-41		Spg. Br.	Bright tin	0.106	0.260	0.410	0.320	0.132	1
5682-44		Spg. Br.	Bright tin	0.132					

\*\*Spg. Br. — Spring Bronze; BeCU — Beryllium Copper.

†Hole in center of both clip and contact area.

**Data Sheet: 2132**

**5672 & 5674 Series**

**PCB Fuseclips with Mounting Holes For 3/32" Diameter Fuses**

Catalog Numbers	End Stop	Clip Mat.**	Finish	Dimensions (in)				Hole Dia.	Fig. Ref.
				B (To End Stop)	C (Contact)	D (Height)	E (Width)		
5672-11	No	Spg. Br.	Bright tin	†	0.362	0.520	0.380	0.172	2
5674-01		BeCU	Silver						
5674-10	Yes	BeCU	Bright tin	0.168	0.356	0.520	0.380	0.172	1
5674-41		Spg. Br.	Bright tin						

\*\*Spg. Br. — Spring Bronze; BeCU — Beryllium Copper.

†Hole in center of both clip and contact area.

**Data Sheet: 2132**

**5956 & 5960 Series**

**PCB Fuseclips with Mounting Holes For 13/32" Diameter Fuses**

Catalog Numbers	End Stop	Clip Mat.**	Finish	Dimensions (in)				Hole Dia.	Fig. Ref.
				B (To End Stop)	C (Contact)	D (Height)	E (Width)		
5956-16	No	Spg. Br.	Bright tin	†	0.312	0.710	0.470	0.172	2
5960-07		BeCU	Silver	0.168				0.196	
5960-09		BeCU	Silver	0.200				0.172	
5960-51	Yes	Spg. Br.	Bright dip*	0.168	0.389	0.710	0.470	0.196	1
5960-53		Spg. Br.	Bright dip*	0.200				0.172	
5960-61		Spg. Br.	Bright tin	0.168				0.196	
5960-62		Spg. Br.	Bright tin	0.168				0.132	
5960-63		Spg. Br.	Bright tin	0.200				0.172	
5960-64		Spg. Br.	Bright tin	0.200				0.128	

\*Bright dip is actually treated bare metal with no plating.

\*\*Spg. Br. = Spring Bronze; BeCU = Beryllium Copper.

†Hole in center of both clip and contact area.

**Data Sheet: 2132**

**5591 & 5592 Series**

**PCB Fuseclips with Mounting Holes For 9/16" Diameter Fuses**

Catalog Number	End Stop	Clip Mat.**	Finish	Dimensions (in)				Hole Dia.	Fig. Ref.
				B (To End Stop)	C (Contact)	D (Height)	E (Width)		
5591-42	Yes	Spg. Br.	Bright dip*	0.260	0.510	0.890	0.600	0.172	1
5592-01		BeCU	Silver					0.200	
5592-11	No	Spg. Br.	Silver	†	0.505	0.890	0.600	0.200	2
5592-33		Spg. Br.	Bright dip*					0.172	

\*Bright Dip is actually treated bare metal with no plating.

\*\*Spg. Br. — Spring Bronze; BeCU — Beryllium Copper.

†Hole in center of both clip and contact area.

**Data Sheet: 2132**

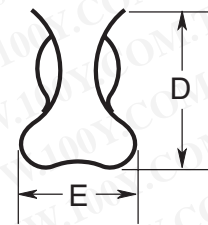
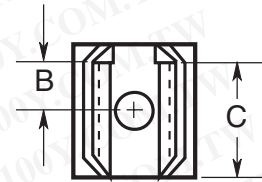

**FIGURE 1**

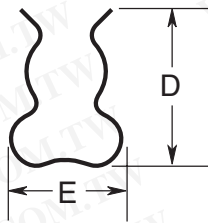
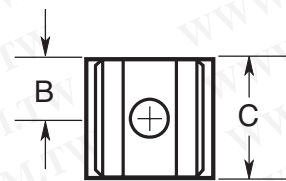

**FIGURE 2**

Electronic Fuses

**COOPER Bussmann**

勝特力材料 886-3-5753170  
勝特力电子(上海) 86-21-34970699  
勝特力电子(深圳) 86-755-83298787  
[Http://www.100y.com.tw](http://www.100y.com.tw)



## Downtime Reduction. Workplace Safety. Code Compliance

Cooper Bussmann® Services increase your productivity through protection.

With our innovative OSCAR™ Compliance Software and arc-flash engineering services, we help you take the confusion out of UL508A SCCR and NFPA70E arc-flash requirements. Cooper Bussmann engineering, training and testing services help you get the most value out of your limited resources.

Contact your local Cooper Bussmann representative for information on our newly expanded services offering, or visit [www.cooperbussmann.com/services](http://www.cooperbussmann.com/services)

**COOPER**

The Power Behind The Brands.



**COOPER** Lighting



**COOPER** Crouse-Hinds



**COOPER** Power Systems



**COOPER** Wiring Devices



**COOPER** B-Line