

勝特力材料 886-3-5753170  
 勝特力电子(上海) 86-21-54151736  
 勝特力电子(深圳) 86-755-83298787  
[Http://www.100y.com.tw](http://www.100y.com.tw)

1SS355

Diodes

# Switching diode

## 1SS355

### ●Applications

High speed switching

### ●Features

- 1) Small surface mounting type.(UMD2)
- 2) High Speed.( $t_{rr}$ =1.2ns Typ.)
- 3) High reliability with high surge current handling capability.

### ●Construction

Silicon epitaxial planar

### ●External dimensions (Units : mm)

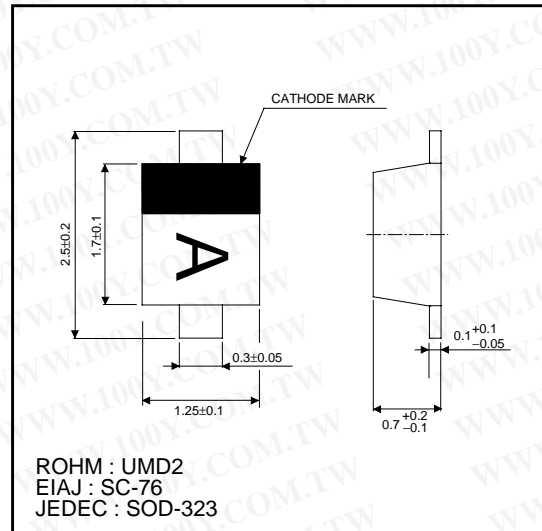

### ●Absolute maximum ratings (Ta=25°C)

Parameter	Symbol	Limits	Unit
Peak reverse voltage	$V_{RM}$	90	V
DC reverse voltage	$V_R$	80	V
Peak forward current	$I_{FM}$	225	mA
Mean rectifying current	$I_o$	100	mA
Surge current (1s)	$I_{surge}$	500	mA
Junction temperature	$T_j$	125	°C
Storage temperature	$T_{stg}$	-55~+125	°C

### ●Electrical characteristics (Ta=25°C)

Parameter	Symbol	Min.	Typ.	Max.	Unit	Conditions
Forward voltage	$V_F$	-	-	1.2	V	$I_F=100mA$
Reverse current	$I_R$	-	-	0.1	$\mu A$	$V_R=80V$
Capacitance between terminals	$C_T$	-	-	3.0	pF	$V_R=0.5V, f=1MHz$
Reverse recovery time	$t_{rr}$	-	-	4	ns	$V_R=6V, I_F=10mA, R_L=100\Omega$

**ROHM**

勝特力材料 886-3-5753170  
 勝特力电子(上海) 86-21-54151736  
 勝特力电子(深圳) 86-755-83298787  
[Http://www.100y.com.tw](http://www.100y.com.tw)

1SS355

Diodes

●Electrical characteristic curves (Ta=25°C)

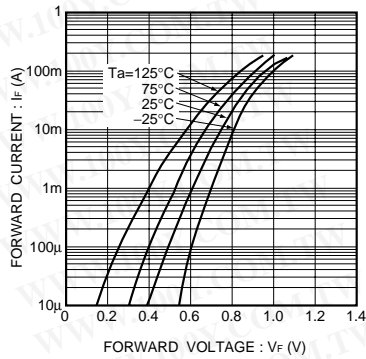

Fig.1 Forward characteristics

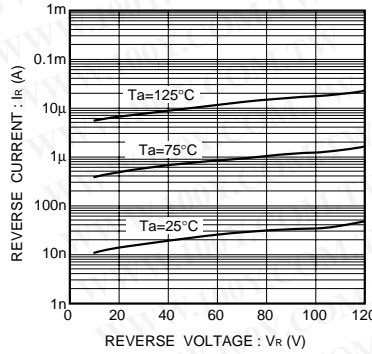

Fig.2 Reverse characteristics

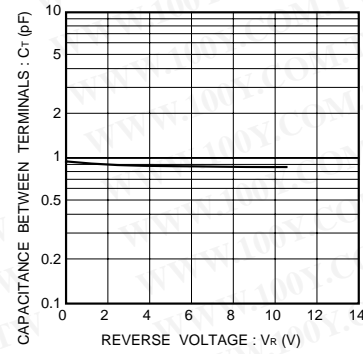

Fig.3 Capacitance between terminals characteristics

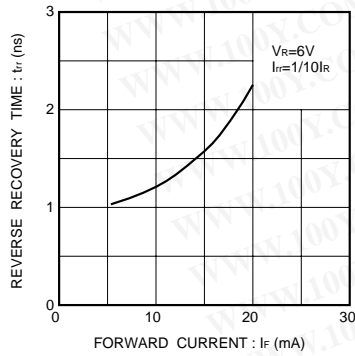

Fig.4 Reverse recovery time characteristics

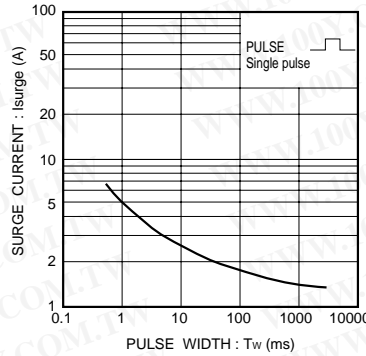

Fig.5 Surge current characteristics

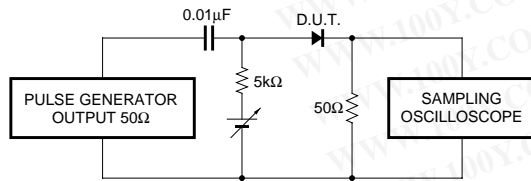

Fig.6 Reverse recovery time (trr) measurement circuit

