

Incandescent reflector

Infrared heat lamps/industrial



R125 E27 Red



R125 E27 CL



R125 E27 FR



PAR38 E27 Red



PAR38 E27 CL

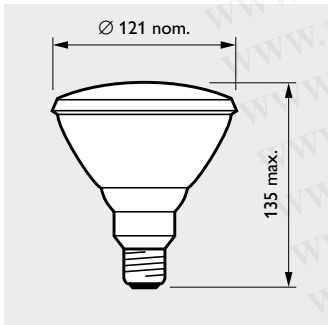

PAR38 IR E26

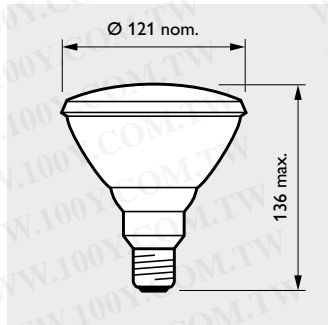

PAR38 IR E27

Features

- 90% of energy is transmitted as infrared
- Lamp lifetime 5000 hours
- Instant, accurately controllable radiant heat
- Easy installation

Benefits

- Simple, safe and clean heat source
- High-efficiency, low energy costs
- Faster-growing, healthier animals

Optimum heating economy and efficiency

Philips infrared lamps are the optimum choice for maximum economy and efficiency in the rearing of pigs, chickens and other livestock, as well as in many other situations where heat is needed. These compact reflector lamps offer instant, accurately controllable heat where and when it is needed. Installation is quick and easy, with no need for costly building work, and the location and intensity of heating can easily be changed at any time.

Ideal for animal rearing

Experience shows that infrared radiant heat makes a significant contribution to optimising animal rearing results.

Growth is more rapid because animals do not need to expend energy on maintaining body temperature. In addition, the risk of infection is reduced because bedding is kept dry, and radiant heat is draught-free.

Earlier farrowing is promoted, especially during winter, and mortality rates are greatly reduced, as young animals can be separated from the mother at an earlier age under infrared heating.

Precisely controllable heat delivery

Optimum economy is achieved not only by low-cost installation, but also by high-efficiency heat delivery to exactly where it is needed. Low thermal inertia of the infrared lamps means there is no delay for warming-up, and conversely heating stops virtually instantly when the lamps are switched off.

Heat delivery is precisely controllable, either manually or by the use of an electronic control system.

Choice of lamp types

Philips offers a choice of two infrared lamp types for radiant heating applications. The R125 blown-bulb types give the lowest possible initial investment, and are available in a wide range of wattages from 150W to 375W. These lamps are also available with a hard glass bulb with high mechanical and thermal strength, and resistance to sudden cooling and water splashes. The optional red lacquered types reduce visible light output (glare) by 75% in situations where visible light is not required.

Optimum economy with PAR38

The alternative PAR38 pressed glass reflector lamps offer optimum lifetime economy thanks to their higher efficiency. These lamps allow energy savings of around 30% to be achieved as a result of their highly efficient reflector and refractor lens design, which ensures that heat is directed precisely to the area where it is needed with minimal spillage. For example a 100W PAR38 lamp radiates the same amount of heat in an 80 cm circle at a 65 cm height as a 150W R125 lamp, while a 175W PAR38 has the same heating effect as a 250W R125 lamp. These PAR38 lamps have a hard glass bulb for optimum resistance to breakage caused by mechanical or thermal shock. PAR38 lamps are also available with red lacquered glass to reduce visual light output.

Long 5,000 hour lifetime

Contributing further to their outstanding economy, all the Philips infrared lamps have a long 5,000 hour lifetime. All types have a universal burning position, except for PAR38 with red lacquered glass, which have a base-up $\pm 45^\circ$ burning position.

Applications

- Agricultural: breeding and rearing of pigs, poultry, calves, foals, dogs etc.
- Veterinary clinics, pet shops, zoos, beauty parlours
- Industrial: heating, drying, baking, carbonising, melting, etc.
- Personal care, hair drying, beauty care, solariums
- General: hot food displays, bathrooms, cookerhoods, space heaters, hobbies.

勝特力材料 886-3-5753170
 勝特力电子(上海) 86-21-34970699
 勝特力电子(深圳) 86-755-83298787
[Http://www.100y.com.tw](http://www.100y.com.tw)



PHILIPS

Incandescent reflector

Infrared heat lamps/industrial

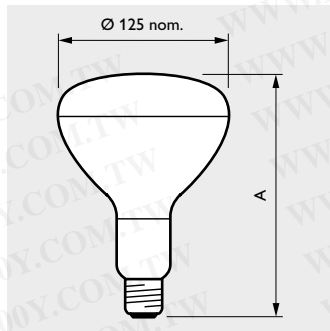

Dimensions in mm

Type	A max.
Cap/base E27	
IR250CH/-S/-300CH	179.0
IR150R/-S/-250R	181.0
IR375CH/-SH	183.0

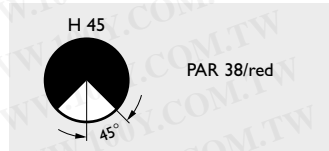
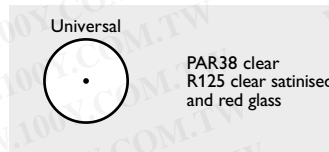

Burning positions

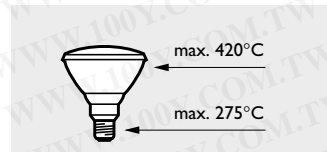

PAR38 100/175 W clear

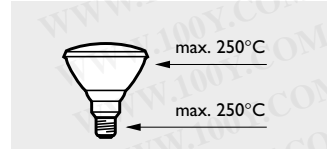

PAR38 100/175 W red

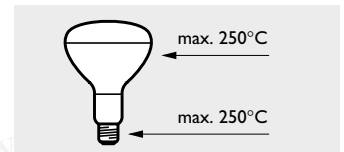

IR150 R / IR250 R

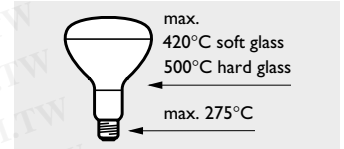

IR150 CS - IR250 CH/-S
IR300 CH/375 CH/375 SH

Permissible bulb base/pinch temperatures

勝特力材料 886-3-5753170
 勝特力电子(上海) 86-21-34970699
 勝特力电子(深圳) 86-755-83298787
[Http://www.100y.com.tw](http://www.100y.com.tw)

Type	Wattage W	Voltage V	Cap/base	Finish	Lamp life 100% h	Nett weight g	Ordering number	EOC
PAR38 IR								
IR100C PAR38	100W	120V	E26	CLEAR	5000	308.00	9238 008 36300	221911
IR100C PAR38	100W	230V	E27	CLEAR	5000	308.00	9238 012 44200	115782
IR100C PAR38	100W	240-250V	E27	CLEAR	5000	308.00	9238 012 45700	128935
IR100R PAR38	100W	115-125V	E26	RED	5000	308.00	9238 004 34600	116255
IR100R PAR38	100W	120V	E26	RED	5000	308.00	9238 004 36300	347260
IR100R PAR38	100W	230V	E27	RED	5000	308.00	9238 011 44200	600523
IR100R PAR38	100W	240-250V	E27	RED	5000	308.00	9238 011 45700	128911
IR175C PAR38	175W	115-125V	E26	CLEAR	5000	308.00	9238 135 34600	112394
IR175C PAR38	175W	230V	E27	CLEAR	5000	308.00	9238 013 44200	115799
IR175C PAR38	175W	240-250V	E27	CLEAR	5000	308.00	9238 013 45700	128959
IR175R PAR38	175W	115-125V	E26	RED	5000	308.00	9238 136 34600	116279
IR175R PAR38	175W	230V	E27	RED	5000	308.00	9238 014 44200	600530
IR175R PAR38	175W	240-250V	E27	RED	5000	308.00	9238 014 45700	128980
R125 HARD GLASS								
IR250CH R125	250W	230-250V	E27	CLEAR	5000	137.10	9232 219 43800	126498
IR300CH R125	300W	230-250V	E27	CLEAR	5000	137.10	9232 230 43800	126566
IR375CH R125	375W	230-250V	E27	CLEAR	5000	137.10	9232 235 43800	126597
IR375SH R125	375W	230V	E27	SAT	5000	137.10	9232 236 44200	126610
R125 SOFT GLASS								
IR150R R125	150W	230-250V	E27	RED	5000	110.20	9232 443 43800	126399
IR150R R125	150W	230V	E27	RED	5000	110.20	9232 443 44200	126382
IR150S R125	150W	230-250V	E27	SAT	5000	110.20	9232 208 43800	-
IR150S R125	150W	230V	E27	SAT	5000	110.20	9232 208 44200	126405
IR250R R125	250W	110-120V	E27	RED	5000	110.20	9232 444 32200	126528
IR250R R125	250W	230-250V	E27	RED	5000	110.20	9232 444 43800	126542
IR250R R125	250W	230V	E27	RED	5000	110.20	9232 444 44200	126535
IR250S R125	250W	110-120V	E27	SAT	5000	110.20	9232 216 32200	122681
IR250S R125	250W	230-250V	E27	SAT	5000	110.20	9232 216 43800	-
IR250S R125	250W	230V	E27	SAT	5000	110.20	9232 216 44200	126443

Note:

The abbreviations as used in the subheader/pridcode have the following meanings:
C = Clear R = Red S = Satinised H = Hard glass



Incandescent reflector

Infrared heat lamps/industrial

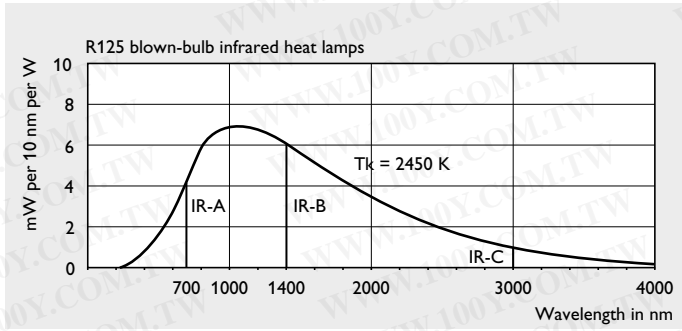

Spectral power distribution

勝特力材料 886-3-5753170
 勝特力电子(上海) 86-21-34970699
 勝特力电子(深圳) 86-755-83298787
[Http://www.100y.com.tw](http://www.100y.com.tw)

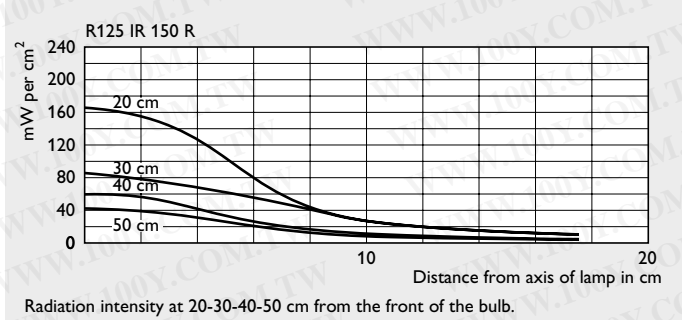

Radiation intensity at 20-30-40-50 cm from the front of the bulb.

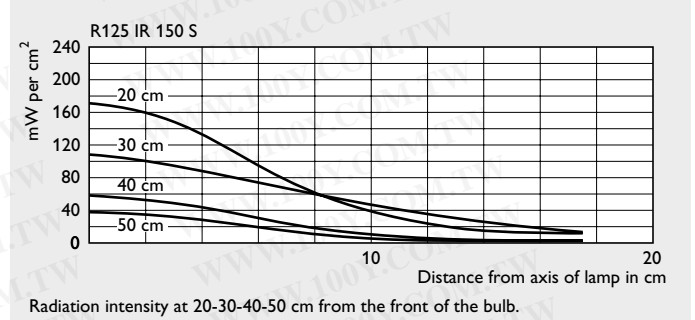

Radiation intensity at 20-30-40-50 cm from the front of the bulb.

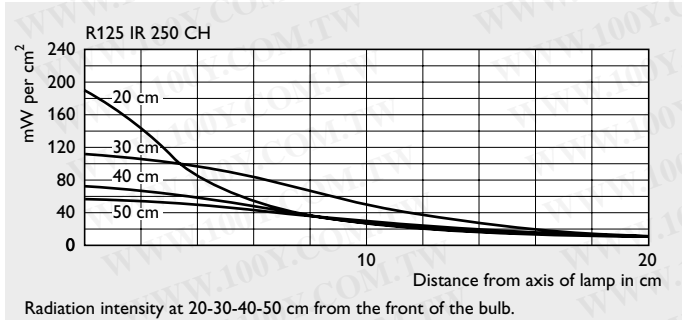

Radiation intensity at 20-30-40-50 cm from the front of the bulb.

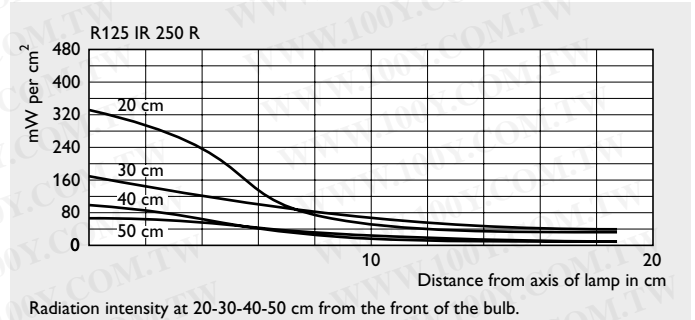

Radiation intensity at 20-30-40-50 cm from the front of the bulb.

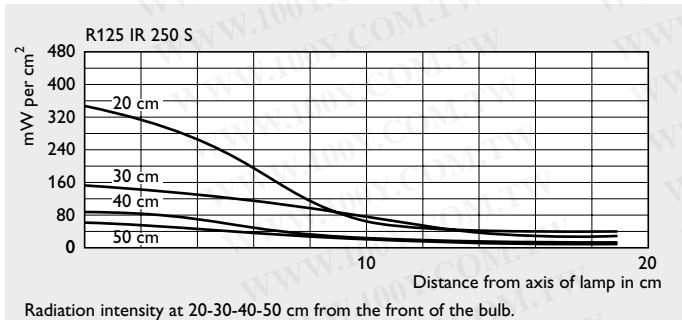

Radiation intensity at 20-30-40-50 cm from the front of the bulb.

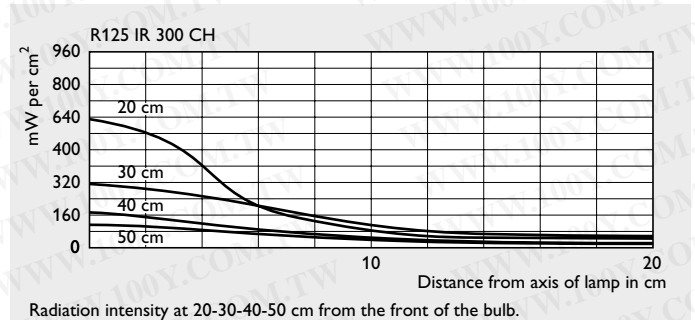

Radiation intensity at 20-30-40-50 cm from the front of the bulb.

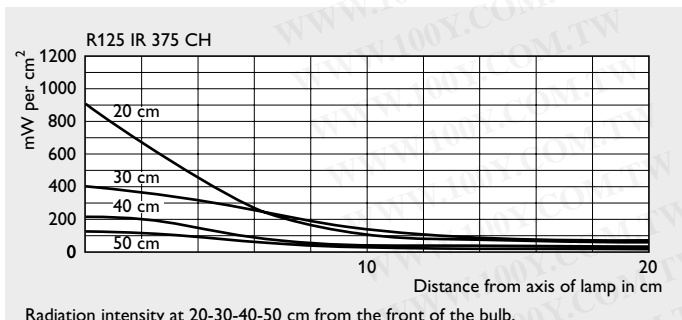

Radiation intensity at 20-30-40-50 cm from the front of the bulb.

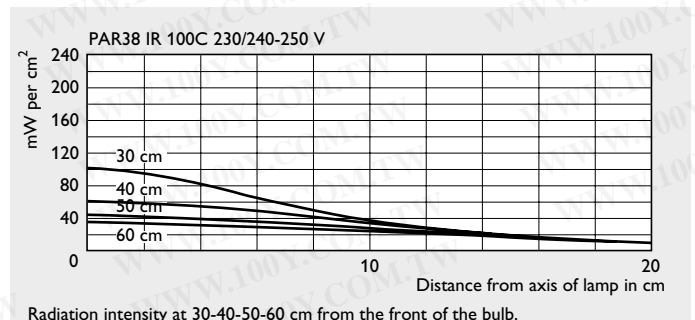

Radiation intensity at 30-40-50-60 cm from the front of the bulb.

Radiation distributions



Incandescent reflector

Infrared heat lamps/industrial

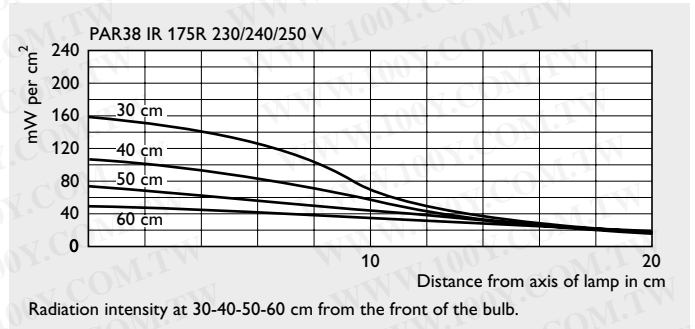
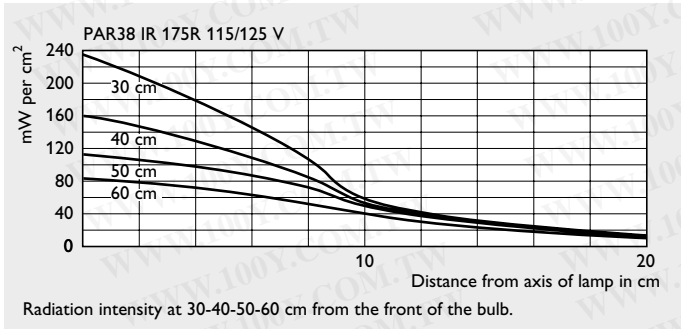
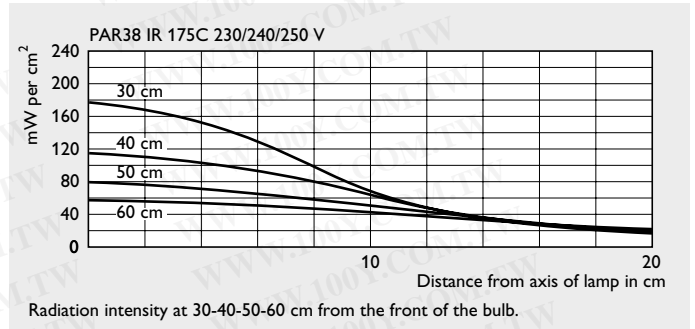
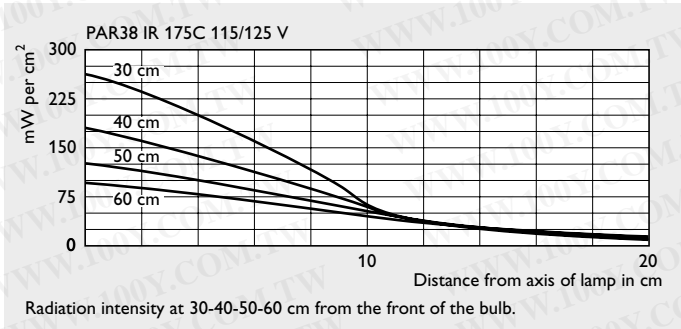
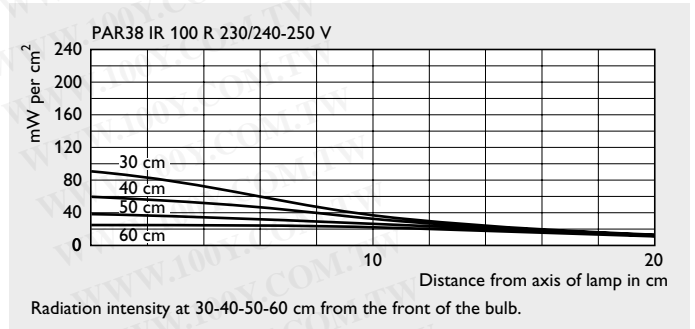
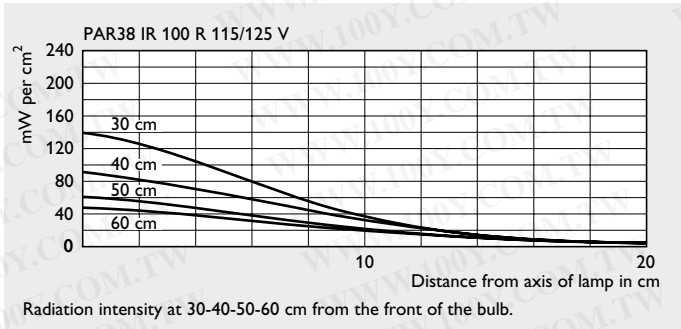

Radiation distributions



勝特力材料 886-3-5753170
 勝特力电子(上海) 86-21-34970699
 勝特力电子(深圳) 86-755-83298787
[Http://www.100y.com.tw](http://www.100y.com.tw)



PHILIPS