

Button Adjustment Fiber Optic Amplifiers



BF4 Series PRODUCT MANUAL

For your safety, read and follow the considerations written in the instruction manual, other manuals and Autonics website.

The specifications, dimensions, etc. are subject to change without notice for product improvement. Some models may be discontinued without notice.

Features

- High response time: max. 0.5 ms
- Auto sensitivity setting (button setting) / remote sensitivity setting type
- External synchronization input, mutual interference protection, self-diagnosis
- Reverse power protection and output short overcurrent protection circuit
- Timer function: OFF delay timer approx. 40 ms fixed.
(standard type, remote sensitivity setting type only)
- Automatically selectable Light ON / Dark ON
- Precise detection of small target and easy to install in the complicated place

Safety Considerations

- Observe all 'Safety Considerations' for safe and proper operation to avoid hazards.
- ⚠ symbol indicates caution due to special circumstances in which hazards may occur.

⚠ Warning Failure to follow instructions may result in serious injury or death.

- 01. Fail-safe device must be installed when using the unit with machinery that may cause serious injury or substantial economic loss.** (e.g., nuclear power control, medical equipment, ships, vehicles, railways, aircraft, combustion apparatus, safety equipment, crime/disaster prevention devices, etc.)
Failure to follow this instruction may result in personal injury, economic loss or fire.
- 02. Do not use the unit in the place where flammable/explosive/corrosive gas, high humidity, direct sunlight, radiant heat, vibration, impact or salinity may be present.**
Failure to follow this instruction may result in explosion or fire.
- 03. Install the unit on DIN rail or panel to use.**
Failure to follow this instruction may result in fire.
- 04. Do not disassemble or modify the unit.**
Failure to follow this instruction may result in fire.
- 05. Do not connect, repair, or inspect the unit while connected to a power source.**
Failure to follow this instruction may result in fire.
- 06. Check 'Connections' before wiring.**
Failure to follow this instruction may result in fire.

⚠ Caution Failure to follow instructions may result in injury or product damage.

- 01. Use the unit within the rated specifications.**
Failure to follow this instruction may result in fire or product damage.
- 02. Use a dry cloth to clean the unit, and do not use water or organic solvent.**
Failure to follow this instruction may result in fire.

Cautions during Use

- Follow instructions in 'Cautions during Use'. Otherwise, it may cause unexpected accidents.
- When connecting an inductive load such as a DC relay, remove surge by using a diode or varistor.
- Use the product after 3 sec of the power input.
- The power supply should be insulated and limited voltage/current or Class 2, SELV power supply device.
- Wire as short as possible and keep it away from high voltage lines or power lines to prevent surge and inductive noise.
- When using switching mode power supply (SMPS), ground F.G. terminal and connect a condenser between 0V and F.G. terminal to remove noise.
- Since external disturbance light (sunlight, fluorescent lighting, etc.) can cause product malfunction, use the product with a light shield or slit.
- When sensing an object with the maximum sensitivity, an error of sensing distance can occur due to the deviation of each feature.
- Turn off the power of the fiber optic amplifier before installation or removal.
- When installing the fiber optic unit, check the bend radius of each unit written on the product manual. If the installed unit that has the bend radius under the rated range, causing optical loss so the sensing distance is shortened.
- Be sure not to scratch the surface of the fiber optic unit.
- Do not pull the cable of the fiber optic unit that is connected to the amplifier.
- This unit may be used in the following environments.
 - Indoors (in the environment condition rated in 'Specifications')
 - Altitude max. 2,000 m
 - Pollution degree 2
 - Installation category III

勝特力電材超市-龍山店 886-3-5773766
 勝特力電材超市-光復店 886-3-5729570
 勝特力電子(上海) 86-21-34970699
 勝特力電子(深圳) 86-755-83298787
<http://www.100y.com.tw>

Ordering Information

This is only for reference, the actual product does not support all combinations. For selecting the specified model, follow the Autonics website.

BF4 ① ② - ③

① Light source

R: Red LED
G: Green LED

③ Features

No mark: Standard type
E: External synchronization input type
R: Remote sensitivity setting type

② Control output

No mark: NPN open collector output
P: PNP open collector output

Product Components

- Product
- Bracket
- Instruction manual
- Bolt / Nut × 2

Sold Separately

- Fiber optic units

Dimensions

- Unit: mm, For the detailed drawings, follow the Autonics website.

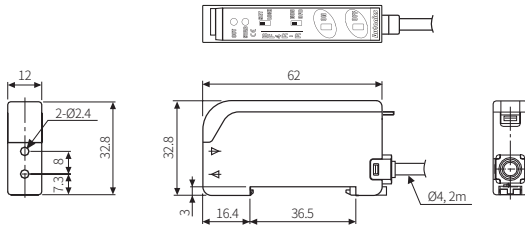

■ Bracket

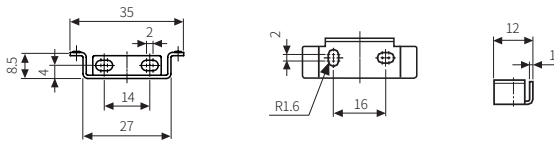

Unit Descriptions

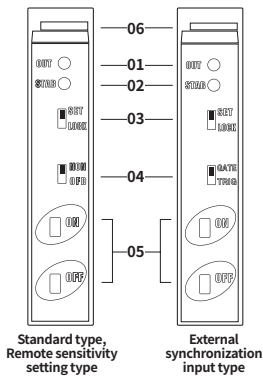

- 01. Operation indicator (red)**
- 02. Stability indicator (green)**
- 03. Setting switch for the mode**
- SET: function setting
- LOCK: lock mode
- 04. Setting switch for the timer / external synchronization**
- NON: not used,
- OFD: OFF Delay mode
- GATE: gate synchronization,
- TRIG: trigger synchronization
- 05. Sensitivity setting button**
- 06. Lever lock**
It is used to fix the fiber optic unit.

Supporting Functions of Each Model

- For more detailed information on functions and settings, refer to the manual.

	Standard type	External synchronization input type	Remote sensitivity setting type
Sensitivity setting by the button	○	○	○
Remote sensitivity setting	-	-	○
Sensitivity setting output (Answer back)	-	-	○
Operation mode of the timer (OFF Delay 40 ms fixed)	○	-	○
Mutual interference prevention	○	○	○
Self-diagnosis output	○	○	○
External synchronization input	-	○	-
Emitter OFF function	-	○	-

Connections

- Connect the diode at the external terminal for inductive load.
- For wiring, refer to the table below.

Color	Function		
	Standard type	External synchronization input type ⁰¹⁾	Remote sensitivity setting type ⁰¹⁾
Brown	+V		
Black	Control output		
White	Self-diagnosis output		
Blue	0 V		
Pink	-	External synchronization input	Remote sensitivity setting ON
Orange	-	Emitter OFF input	Remote sensitivity setting OFF

01) Signal condition
High: 4.5-30 VDC≐ or Open, Low: 0-1 VDC≐

■ Standard type

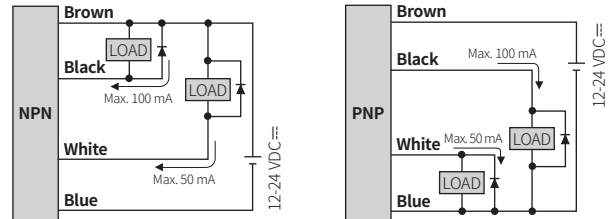

■ External synchronization input type / Remote sensitivity setting type

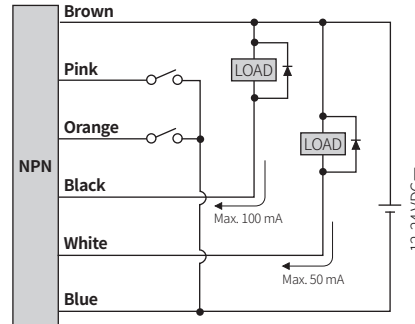

Circuit

■ Standard type

- NPN open collector output
- PNP open collector output

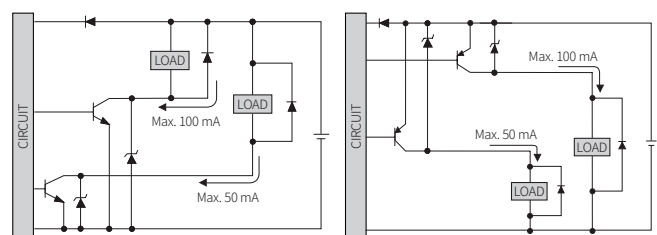

■ External synchronization input type / Remote sensitivity setting type

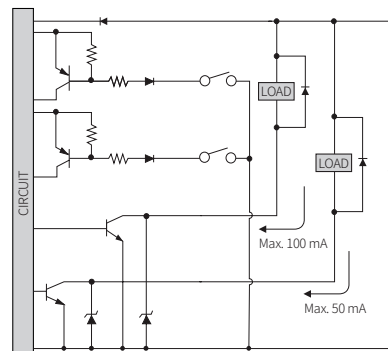

Specifications

Model	BF4R□□-□	BF4G□□-□
Light source	Red LED	Green LED
Peak emission wavelength	660 nm, modulated	525 nm, modulated
Response time	Built-in 2 differential frequencies (frequency 1: ≤ 0.5 ms, frequency 2: ≤ 0.7 ms)	
Sensitivity setting	Button / Remote sensitivity setting	
Operation mode	Light ON / Dark ON selectable	
Self-diagnosis output	YES	
Load voltage	≤ 30 VDC≐	
Load current	≤ 50 mA	
Residual voltage	NPN: ≤ 1 VDC≐ (load current: 50 mA), ≤ 0.4 VDC≐ (load current: 16 mA) PNP: ≤ 2.5 VDC≐	
Indicator	Operation indicator (red), stability indicator (green)	
Approval	CE 标志	CE 标志
Unit weight (packaged)	≈ 65 g (≈ 120 g)	≈ 65 g (≈ 120 g)

Power supply	12-24 VDC≐ ± 10% (ripple P-P: ≤ 10%)
Current consumption	≤ 45 mA
Control output	NPN open collector output / PNP open collector output model
Load voltage	≤ 30 VDC≐
Load current	≤ 100 mA
Residual voltage	NPN: ≤ 1 VDC≐ (load current: 100 mA), ≤ 0.4 VDC≐ (load current: 16 mA) PNP: ≤ 2.5 VDC≐
Protection circuit	Reverse power protection circuit, output short overcurrent protection circuit
Insulation resistance	≥ 20 MΩ (500 VDC≐ megger)
Noise immunity	± 240 VDC≐: the square wave noise (pulse width: 1 μs) by the noise simulator
Dielectric strength	Between the charging part and the case: 1,000 VAC ~ 50 / 60 Hz for 1 min
Vibration	1 mm double amplitude at frequency 10 to 55 Hz in each X, Y, Z direction for 2 hours
Shock	500 m/s ² (≈ 50 G) in each X, Y, Z directions for 3 times
Ambient illuminance (receiver)	Sunlight: ≤ 11,000 lx, incandescent lamp: ≤ 3,000 lx
Ambient temperature	-10 to 50 °C, storage: -20 to 70 °C (no freezing or condensation)
Ambient humidity	35 to 85%RH, storage: 35 to 85%RH (no freezing or condensation)
Cable spec.	Standard type: Ø 4 mm, 4-wire, 2 m External synchronization input, remote sensitivity setting type: Ø 4 mm, 6-wire, 2 m
Wire spec.	Standard type: AWG22 (0.08 mm, 60-core), insulator outer diameter: Ø 1.25 mm External synchronization input, remote sensitivity setting type: AWG24 (0.08 mm, 40-core), insulator outer diameter: Ø 1 mm
Material	Case: heat-resistance ABS, cover: PC

DIN Rail Mount and Removal

Mount

- Hang up the holder on the backside of the amplifier to the DIN rail (35 mm).
- Press the front side of the amplifier toward the DIN rail.

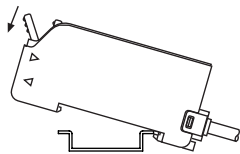

Removal

- Slide the amplifier to direction ①.
- Lift the front side of the amplifier to direction ②.

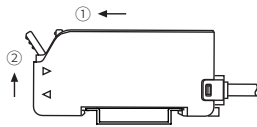

Insert Fiber Optic Unit

- Lift the protective cover and lower down the lever lock.
- Insert the cable of the fiber optic unit to the slot completely.
(▷ : receiver part, ◁ : emitter part)

Length (mm)	Receiver part	Emitter part
a ⁰¹⁾	11	
b		10

Amplifier 01) With the adaptor attached

- Lift the lever lock to fix the fiber optic unit and close the protective cover.

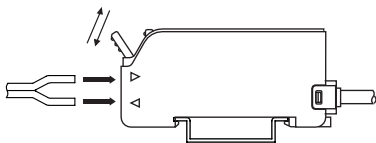

Operation Timing Chart and Indicators

Operation mode	Light ON	Dark ON
Received light	Received Interrupted	Received Interrupted
Operation indicator (red)	ON OFF	ON OFF
Transistor output	ON OFF	ON OFF

Sensitivity Setting

- For wiring, refer to the 'Connections.'
- After the power is turned off, the settings are saved.
- Before the sensitivity setting, mount the fiber optic unit first.

Sensitivity of the operation

STEP	State		Descriptions
	Light ON	Dark ON	
01	-	-	Select [SET] on the setting switch for the mode.
02	Received	Interrupted	Press [ON] button.
03	Received	Interrupted	The stability indicator (green) flashes under the ON state.
04	Interrupted	Received	Press [OFF] button.
05	-	-	- Stable sensing condition: the stability indicator (green) flashes once. - Unstable sensing condition: the stability indicator (green) flashes 5 times.
06	-	-	Select [LOCK] on the setting switch for the mode to prevent changing the sensitivity.

Maximum sensitivity

The max. sensitivity supports the stable performance of the sensor in the following environments.

- Through-beam type: poor sensing environment that there is lots of dust.
- Reflective type: sensing distance should be extended for detecting targets with high or low reflectivity.

STEP	State	Descriptions
01	-	Select [SET] on the setting switch for the mode.
02	Through-beam type : received Reflective type : interrupted	Light ON: press the buttons [ON] → [OFF]. Dark ON: press the buttons [OFF] → [ON].
03	-	Select [LOCK] on the setting switch for the mode to prevent changing the sensitivity.

Remote sensitivity setting

You can adjust the sensitivity with the externally connected switches without the setting switch for the mode.

Be aware that the sensitivity setting is available under the [LOCK] condition of the mode. Otherwise, it may result in malfunction of the amplifier. Refer to the 'Sensitivity Setting Output (Answer back)' function.

STEP	State	Light ON	Dark ON
01	Received	Switch (SW1): ON → OFF	Switch (SW2): ON → OFF
02	Interrupted	Switch (SW2): ON → OFF	Switch (SW1): ON → OFF

Sensitivity Setting Output (Answer back)

- When ON or OFF input of remote sensitivity setting is applied, after approx. 300 ms, the answer back function activates for 40 ms to alert detectable state. Be sure to maintain the value of received light level about 300 ms.
- The answer back function deactivates under unstable sensing performance. But ON or OFF input of remote sensitivity setting is applied, after 340 ms, it is possible to the detectable state.
- Refer to the timing chart below. This is based on the Light ON.

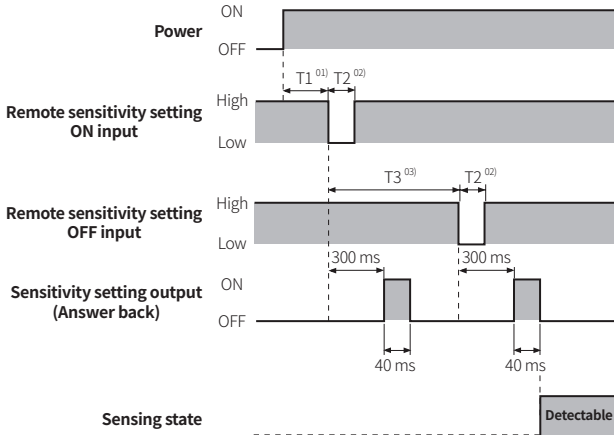

01) After the power on, it can be set after about 1 sec: $T1 \geq 1,000$ ms

02) Input time of the remote sensitivity setting: $T2 \geq 5$ ms

03) When ON input of remote sensitivity setting is applied, and after 500 ms, apply OFF input of remote sensitivity setting.

Timer Operation Mode

- You can select the operation mode of the timer via the setting switch for the timer.
- OFF Delay mode: delay the OFF timing of the control output about 40 ms (fixed).

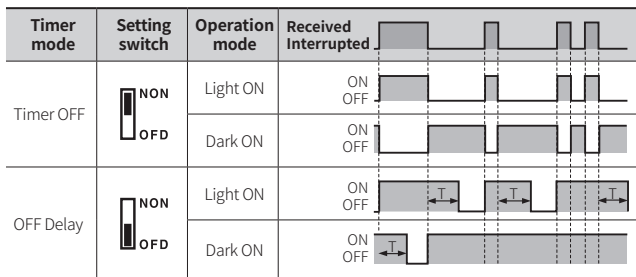

• T: ≈ 40 ms

Mutual Interference Prevention

- Different transmission frequencies make 2 amplifiers to be mounted very closely.
- Response time: frequency 1 ≤ 0.5 ms, frequency 2 ≤ 0.7 ms

STEP		Amplifier 1 (frequency 1)	Amplifier 2 (frequency 2)
01	SET LOCK	Select [SET] on the setting switch for the mode.	
02	ON OFF	Press [ON] and [OFF] buttons at the same time for 2 sec.	
03	ON OFF	The stability indicator (green) flashes.	
04	-	Press [ON] button.	Press [OFF] button.
06	SET LOCK	The stability indicator (green) turns OFF. Select [LOCK] on the setting switch for the mode.	

Self-diagnosis Output

- The output of self-diagnosis turns ON in these conditions: the contaminated hood of fiber optic units, lowered light level of the emitter, missing of the optical axis, overload, and short of control output.
- Refer to the operation timing chart below. This is based on the Light ON.
- The output of self-diagnosis turns ON when the sensing state remains over 300 ms under unstable light level, whereas, the output turns OFF under the stable level (section ①).

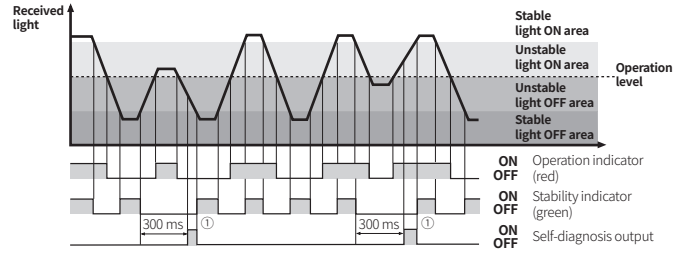

External Synchronization Input

- For wiring, refer to the 'Connections.'
- You can select the synchronization input type and control the timing of the control output via the switch for the external synchronization input.

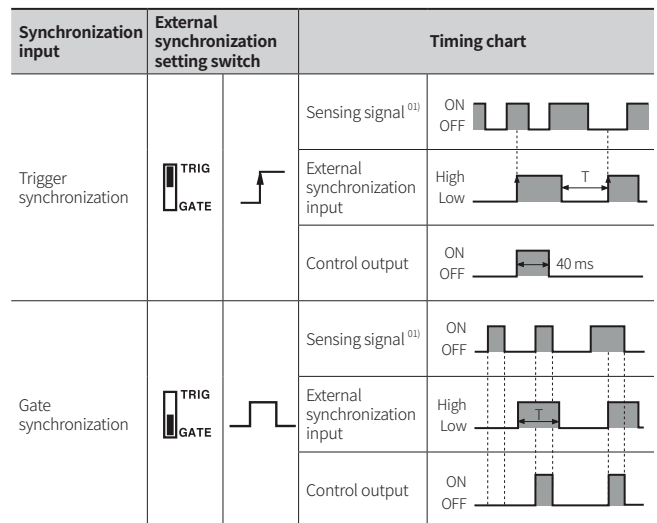

01) Sensing signal: the state that the sensing signal is unreached the control output.

• $T \geq 0.5$ ms (when using the mutual interference prevention: $T \geq 0.7$ ms)

Emitter OFF

- For wiring, refer to the 'Connections.'
- This function helps to check the sensor operates in a normal state and is activated when the light is received.

Input of the emitter OFF	Function
High or Open	Activate emitting
Low	Stop emitting

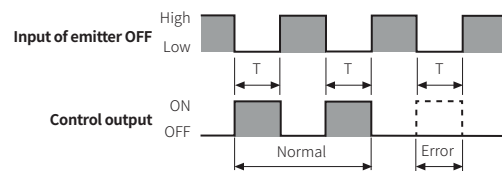

• Control output: Dark ON mode

• $T \geq 0.5$ ms (when using the mutual interference prevention: $T \geq 0.7$ ms)

• Error state of the sensor: when the control output dose not turn ON

Characteristic Curves: Through-beam Type

Fiber optic unit model: FT-420-10

■ Sensing area

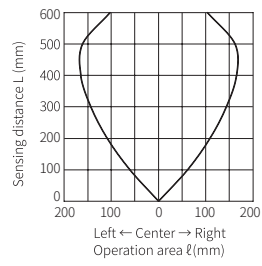
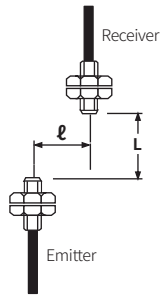

Characteristic Curves: Reflective Type

Fiber optic unit model: FD-620-10

■ Sensing area

