

Programmable Digital Counters / Timers



CT Series PRODUCT MANUAL

For your safety, read and follow the considerations written in the instruction manual, other manuals and Autonics website.

The specifications, dimensions, etc. are subject to change without notice for product improvement. Some models may be discontinued without notice.

Features

- Communication function supported (communication model): RS485 (Modbus RTU)
- One-shot output time setting range: 0.01 sec to 99.99 sec by setting per 10ms

[Counter]

- Prescale value setting range: 6-digit model: 0.00001 to 99999.9 / 4-digit model: 0.001 to 999.9
- Various input / output modes (9 input / 11 output modes)
- BATCH counter, count Start Point (counting initial value) setting function

[Timer]

- Various output modes (13 modes)
- Various time setting range: 6-digit model: 0.001 sec to 99999.9 hour / 4-digit model: 0.001 sec to 9999 hour
- '0' time setting function
- Selectable timer memory retention function for indicator model.

Safety Considerations

- Observe all 'Safety Considerations' for safe and proper operation to avoid hazards.
- **⚠** symbol indicates caution due to special circumstances in which hazards may occur.

⚠ Warning Failure to follow instructions may result in serious injury or death.

- 01. Fail-safe device must be installed when using the unit with machinery that may cause serious injury or substantial economic loss. (e.g. nuclear power control, medical equipment, ships, vehicles, railways, aircraft, combustion apparatus, safety equipment, crime / disaster prevention devices, etc.)**
Failure to follow this instruction may result in personal injury, economic loss or fire.
- 02. Do not use the unit in the place where flammable / explosive / corrosive gas, humidity, direct sunlight, radiant heat, vibration, impact, or salinity may be present.**
Failure to follow this instruction may result in explosion or fire.
- 03. Install on a device panel to use.**
Failure to follow this instruction may result in fire or electric shock.
- 04. Do not connect, repair, or inspect the unit while connected to a power source.**
Failure to follow this instruction may result in fire or electric shock.
- 05. Check 'Connections' before wiring.**
Failure to follow this instruction may result in fire.
- 06. Do not disassemble or modify the unit.**
Failure to follow this instruction may result in fire or electric shock.

⚠ Caution Failure to follow instructions may result in injury or product damage.

- 01. When connecting the power / sensor input, relay output and communication, use AWG 20 (0.50 mm²) cable or over, and tighten the terminal screw with a tightening torque of 0.74 to 0.90 N m.**
Failure to follow this instruction may result in fire or malfunction due to contact failure.
- 02. Use the unit within the rated specifications.**
Failure to follow this instruction may result in fire or product damage.
- 03. Use a dry cloth to clean the unit, and do not use water or organic solvent.**
Failure to follow this instruction may result in fire or electric shock.
- 04. Keep the product away from metal chip, dust, and wire residue which flow into the unit.**
Failure to follow this instruction may result in fire or product damage.

Cautions during Use

- Follow instructions in 'Cautions during Use'.
Otherwise, it may cause unexpected accidents.
- Power supply should be insulated and limited voltage / current or Class 2, SELV power supply device.
- Use the product, 0.1 sec after supplying power.
- When supplying or turning off the power, use a switch or etc. to avoid chattering.
- Install a power switch or circuit breaker in the easily accessible place for supplying or disconnecting the power.
- When the counter is operating, in case of contact input, set count speed to low speed mode (1 cps or 30 cps) to operate. If set to high speed mode (1 k, 5 k, 10 kcps), counting error occurs due to chattering.
- Use twisted pair wire for communication line.
- Keep away from high voltage lines or power lines to prevent inductive noise.
In case installing power line and input signal line closely, use line filter or varistor at power line and shielded wire at input signal line.
Do not use near the equipment which generates strong magnetic force or high frequency noise.
- This unit may be used in the following environments.
 - Indoors (in the environment condition rated in 'Specifications')
 - Altitude max. 2,000 m
 - Pollution degree 2
 - Installation category II

勝特力電材超市-龍山店 886-3-5773766
 勝特力電材超市-光復店 886-3-5729570
 勝特力電子(上海) 86-21-34970699
 勝特力電子(深圳) 86-755-83298787
<http://www.100y.com.tw>

Ordering Information

This is only for reference, the actual product does not support all combinations.
For selecting the specified model, follow the Autonics website.

CT ① ② - ③ ④ ⑤

① Display digits

4: 4-digit
6: 6-digit

② Size

S: DIN W 48 × H 48 mm
Y: DIN W 72 × H 36 mm
M: DIN W 72 × H 72 mm

③ Output

1P: 1-stage preset
2P: 2-stage preset
I: indicator

④ Power supply

2: 24 VAC ~ ± 10 % 50 / 60 Hz,
24 - 48 VDC = ± 10 %
4: 100 - 240 VAC ~ ± 10 % 50 / 60 Hz

⑤ Communication

No mark: none
T: RS485 communication output

Manual

For proper use of the product, refer to the manuals and be sure to follow the safety considerations in the manuals.
Download the manuals from the Autonics website.

Dimensions

• Unit: mm, For the detailed drawings, follow the Autonics website.

■ CTS

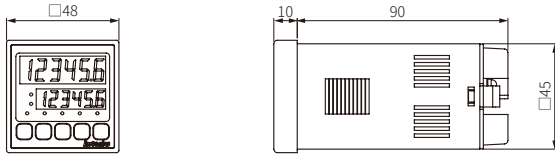

■ CTY

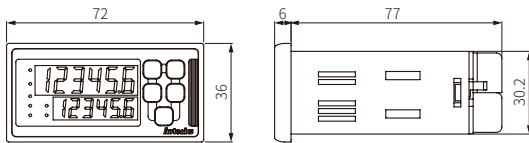

■ CTM

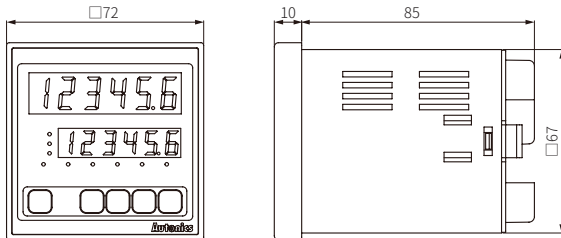

■ Bracket

• CTS

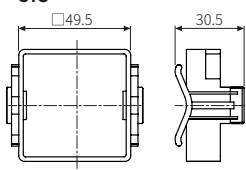

• CTY

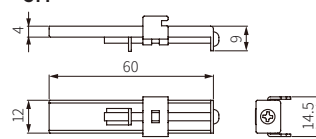

• CTM

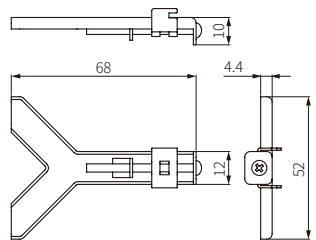

■ Panel cut-out

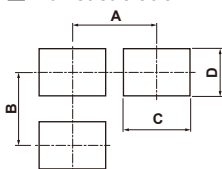

	A	B	C	D
CTS	≥ 65	≥ 65	45 ^{+0.6}	45 ^{+0.6}
CTY	≥ 91	≥ 40	68 ^{+0.7}	31.5 ^{+0.5}
CTM	≥ 91	≥ 91	68 ^{+0.7}	68 ^{+0.7}

Unit Descriptions

• CTS

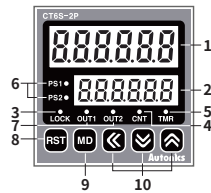

• CTY

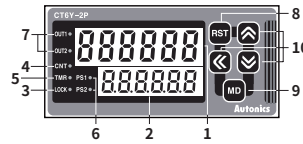

• CTM

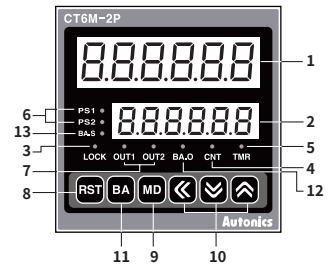

No.	Part name	Name plate	Function
1	Counting value display part (red)	-	RUN mode: Displays counting value, time progress value Parameter 1, 2 group: Displays setting item
2	Setting value display part (green)	-	RUN mode: Displays setting value Parameter 1, 2 group: Displays setting content
3	Key LOCK indicator	LOCK	Turns ON for key LOCK setting
4	Counter indicator	CNT	Turns ON for counter operation
5	Timer indicator	TMR	In timer operation - Flashes: time progress / turns ON: stopping time
6	Preset value checking, changing indicator	PS1, PS2	Turns ON when checking and changing preset value
7	Output indicator	OUT1, OUT2	Turns ON for the dedicated control output ON
8	RESET key	[RST]	Counting value RESET, BATCH counting value RESET
9	MODE key	[MD]	RUN mode ↔ Parameter 1, 2 group Move to the next when the parameter setting
10	Setting key	[◀]	Enter preset value change mode and move digits
		[▼], [▲]	Preset value of preset value change mode and setting content of parameter 1, 2 group Enter function setting check mod and move check items
		[▶]	Enter preset value change mode and move digits
11	BATCH key	[BA]	Enter BATCH counter indication mode
12	BATCH output indicator (red)	BA.O	Turns ON when BATCH output ON
13	BATCH setting value checking, changing indicator (green)	BA.S	Turns ON when checking and changing BATCH setting value

Connections

- Counter operation: If INHIBIT signal is applied, count input will be prohibited.
- Timer operation: If INHIBIT signal is applied, time progressing will stop.(HOLD)
- SOURCE: 100 - 240 VAC ~ 50 / 60 Hz 12 VA
24 VAC ~ 50 / 60 Hz 10 VA, 24 - 48 VDC = 8 W

■ CTS

• 1-stage preset, standard model (CT□S-1P□)

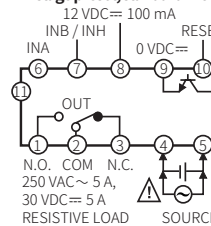

• 1-stage preset, comm. model (CT□S-1P□T)

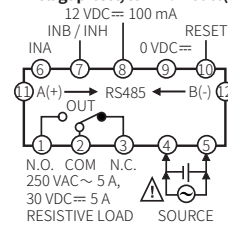

• 2-stage preset, standard model (CT□S-2P□)

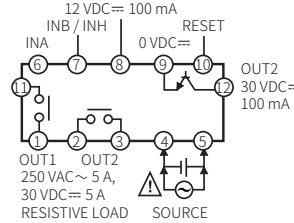

• 2-stage preset, comm. model (CT□S-2P□T)

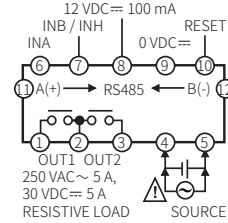

• Indicator, standard model (CT6S-I□)

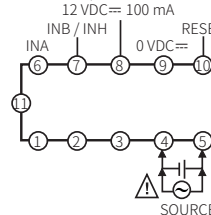

• Indicator, comm. model (CT6S-I□T)

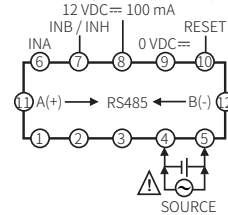

CTY

1-stage preset, standard model (CT6Y-1P□□)

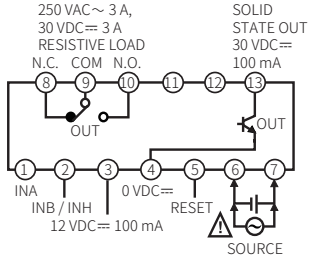

1-stage preset, comm. model (CT6Y-1P□T)

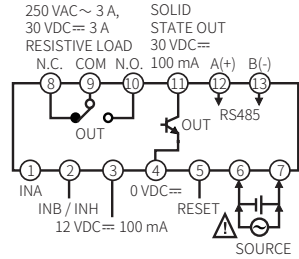

2-stage preset, standard model (CT6Y-2P□□)

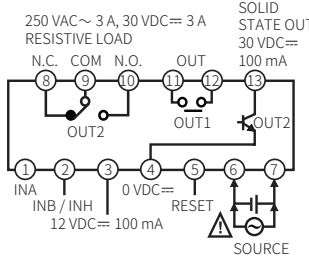

2-stage preset, comm. model (CT6Y-2P□T)

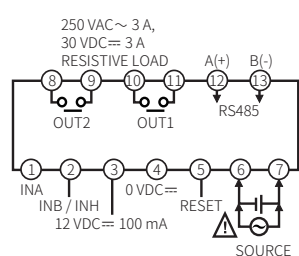

Indicator, standard model (CT6Y-I□□)

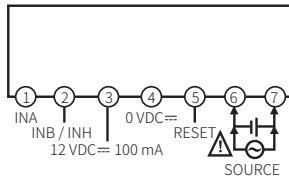

Indicator, comm. model (CT6Y-I□T)

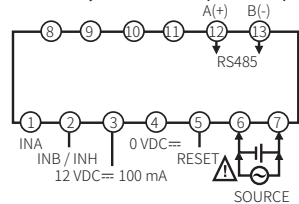

CTM

1-stage preset, standard model (CT6M-1P□□)

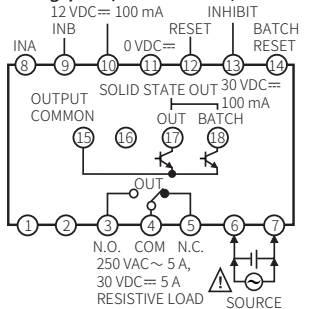

1-stage preset, comm. model (CT6M-1P□T)

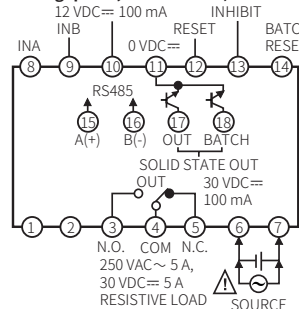

2-stage preset, standard model (CT6M-2P□□)

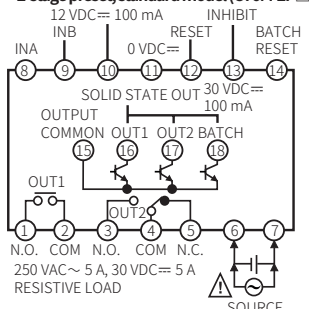

2-stage preset, comm. model (CT6M-2P□T)

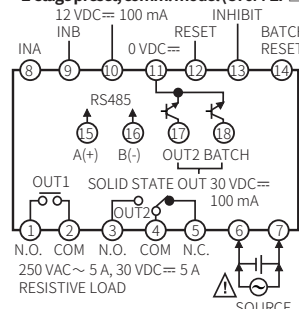

Indicator, standard model (CT6M-I□□)

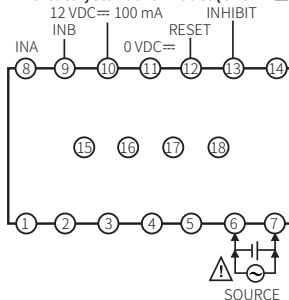

Indicator, comm. model (CT6M-I□T)

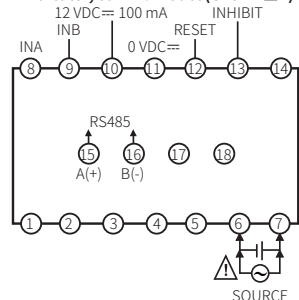

Specifications

Model	CTS□-□□□	CTY□-□□□	CTM□-□□□
Display digits	4-digit	6-digit	6-digit
Display method	7-segment (counting value: red, setting value: green) LED		
Character size	W × H (unit: mm)		
Counting value	6.5 × 10	4.5 × 10	4.2 × 9.5
Setting value	4.5 × 8	3.5 × 7	3.5 × 7
Counter	Count up, count down, count up / down		
Counting range ⁰¹⁾	-999 to 9999	-99999 to 999999	
Timer	Count up, count down		
Error	Repeat / SET / voltage / Temp. - Power ON Start: ≤ ± 0.01 % ± 0.05 sec Signal ON Start: ≤ ± 0.01 % ± 0.03 sec		
Input logic	Voltage input (PNP) - input impedance: 5.4 kΩ, [H]: 5 - 30 VDC=, [L]: 0 - 2 VDC= No-voltage input (NPN) - short-circuit impedance: ≤ 1 kΩ, short-circuit residual voltage: ≤ 2 VDC=		
One-shot output time	0.01 to 99.99 s		
Product components	Product, instruction manual		
Bracket	Mounted	× 2	× 2
Unit weight (packaged)	≈ 159 g (≈ 212 g)	≈ 140 g (≈ 228 g)	≈ 252 g (≈ 322 g)
Certification	CE, RoHS, REACH, ENEC		

01) It varies depending on the setting of decimal points.

Model	CTS□-□□□	CTY□-□□□	CTM□-□□□
Contact control output	Relay		
Type (1-stage)	SPDT (1c) × 1	SPDT (1c) × 1	SPDT (1c) × 1
Type (2-stage)	SPST (1a) × 2	Standard: SPST (1a) × 1, Communication: SPST (1a) × 2	SPST (1a) × 1, SPDT (1c) × 1
Capacity	250 VAC ~ 5 A, 30 VDC = 5 A resistive load	250 VAC ~ 3 A, 30 VDC = 3 A resistive load	250 VAC ~ 5 A, 30 VDC = 5 A resistive load
Solid-state control output	NPN open collector		
Type (1-stage)	Standard: × 1, Communication: -	Standard: × 1, Communication: × 1	Standard: × 2, Communication: × 2
Type (2-stage)	Standard: × 1, Communication: -	Standard: × 1, Communication: -	Standard: × 3, Communication: × 2
Capacity	≤ 30 VDC=, 100 mA	≤ 30 VDC=, 100 mA	≤ 30 VDC=, 100 mA

Voltage	AC voltage type	AC / DC voltage type
Power supply	100 - 240 VAC ~ 50 / 60 Hz	24 VAC ~ 50 / 60 Hz, 24 - 48 VDC=
Permissible voltage range	90 to 110 % of rated voltage	
Power consumption	≤ 12 VA	AC: ≤ 10 VA, DC: ≤ 8 W
External power supply	≤ 12 VDC= ± 10 % 100 mA	
Memory retention	≈ 10 years (non-volatile semiconductor memory type)	
Insulation resistance	≥ 100 MΩ (500 VDC= megger)	
Dielectric strength	Between the charging part and the case : 3,000 VAC ~ 50 / 60 Hz for 1 minute	Between the charging part and the case : 2,000 VAC ~ 50 / 60 Hz for 1 minute
Noise immunity	± 2 kV square wave noise (pulse width: 1 μs) by the noise simulator	± 500 V square wave noise (pulse width: 1 μs) by the noise simulator
Vibration	0.75 mm double amplitude at frequency of 10 to 55 Hz in each X, Y, Z direction for 1 hour	
Vibration (malfunction)	0.5 mm double amplitude at frequency of 10 to 55 Hz in each X, Y, Z direction for 10 min	
Shock	300 m/s ² (≈ 30 G) in each X, Y, Z direction for 3 times	
Shock (malfunction)	100 m/s ² (≈ 10 G) in each X, Y, Z direction for 3 times	
Relay life cycle	Mechanical: ≥ 1,000,000 operations Electrical: ≥ 100,000 operations	
Ambient temperature	-10 to 55 °C, storage: -25 to 65 °C (no freezing or condensation)	
Ambient humidity	35 to 85 %RH, storage: 35 to 85 %RH (no freezing or condensation)	
Protection rating	IP65 (front part, IEC standard)	

Communication Interface

RS485

Comm. protocol	Modbus RTU (16-bit CRC)
Application standard	Compliance with EIA RS485
Max. connection	31-unit (address: 1 to 127)
Comm. synchronous method	Asynchronous
Comm. method	2-wire half duplex
Comm. distance	≤ 800 m
Comm. speed	2,400 / 4,800 / 9,600 (default) / 19,200 / 38,400 bps
Comm. response time	5 to 99 ms (default: 20 ms)
Start bit	1-bit (fixed)
Data bit	8-bit (fixed)
Parity bit	None (default), Even, Odd
Stop bit	1-bit, 2-bit (default)
EEPROM life cycle	≈ 1,000,000 operations (Erase / Write)

Software

Download the installation file and the manuals from the Autonics website.

DAQMaster

It is the comprehensive device management program for Autonics' products, providing parameter setting, monitoring and data management.

Detach the Case

■ CTS, CTY

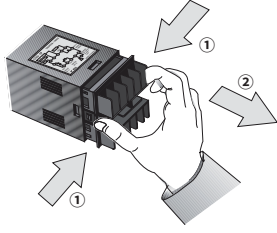

- Press to direction ① and pull toward direction ② for detaching the case and contents.

⚠ **Caution: Turn OFF the power before detaching the case.**

Select Input Logic

- For CTS, CTY, detach the case and proceed the settings. See the 'Detach the Case'.
- The position of internal switch varies depending on the each model.
- How to change the settings:
power OFF → change settings → power ON → press [RESET] key or input the RESET signal (≥ 20 ms) to the external terminal.

■ CTS, CTY

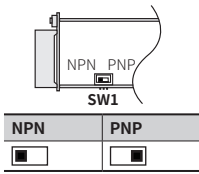

NPN	PNP
<input type="checkbox"/>	<input type="checkbox"/>

■ CTM

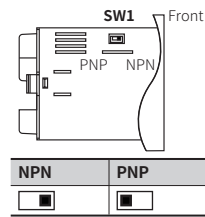

NPN	PNP
<input type="checkbox"/>	<input type="checkbox"/>

Mode Setting

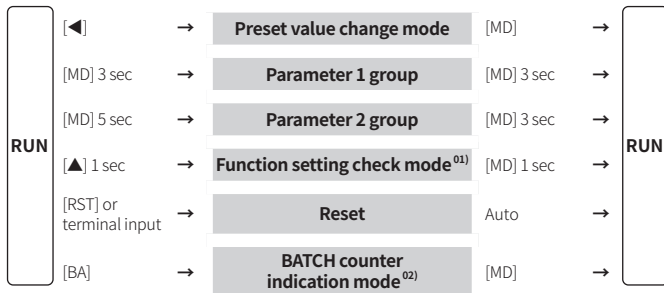

01) Use [▲], [▼] key to check the parameter setting.
In 2-stage preset model, 1-stage preset value and 2-stage preset value are displayed each time when pressing [MD] key. In timer, it is available for the output operation mode: OND, OND.1, OND.2.

02) For CT6M-1P / 2P model only. Press [▶] key to set BATCH counter setting value.

Preset Value Change Mode

- Even if the mode of preset value change, input operation and output control will continue. The preset value could be set to 0 and the output of 0 preset value occurs.
- The preset value could not be set to 0 depending on the output operation mode. (When setting to 0, the value of setting value display part flashes 3 times.)
 - If no key is touched for 60 sec, the product will return to RUN mode without being restored. E.g.: To set 1-stage preset value = 180, 2-stage preset value = 200
 1. Press [▶] key to enter preset value change mode. PS1 indicator turns ON and 1 digit of preset value flashes.
 2. Use [◀], [▲], [▼] key to set 1-stage preset value = 180.
 3. Press [MD] key to enter 2-stage preset value change mode.
 4. Use [◀], [▲], [▼] key to set 2-stage preset value = 200.
 5. Press [MD] key to return RUN mode.

Reset

In RUN mode, if pressing [RST] key or applying the signal to RESET terminal on the back side, present value will be reset. For RESET signal terminals based on the input method, refer to the 'Connections' and the following table. The output maintains OFF state.

Model	Input logic	
	No-voltage (NPN)	Voltage (PNP)
CTS	Short no. 9, 10 terminals	Short no. 8, 10 terminals
CTY	Short no. 4, 5 terminals	Short no. 3, 5 terminals
CTM	Short no. 11, 12 terminals	Short no. 10, 12 terminals

Error Display and Output Operation

- When error occurs, the output turns OFF.
- When setting 1-stage preset value = 0, OUT1 output turns OFF.
- In case of 2-stage preset value < 1-stage preset value, OUT1 output is ignored and only OUT2 output operates.
- Indicator model does not have error display function.

Display	Description	Troubleshooting
Error	Preset value = 0	Change the preset value anything but 0.

Parameter Setting

- Some parameters are activated / deactivated depending on the model or setting of other parameters. Refer to the description of each parameter.
- If changing the setting value of parameter 1 group via communication, reset display value, and output.
- [MD] key: Saves current setting value and moves to the next parameter.
- [◀] key: Checks fixed value / Changes setting digits.
- [▲], [▼] key: Changes setting values.

■ Parameter 1 group (counter)

Parameter	Mark	Defaults	Setting range	Display condition
C1-1 Counter / timer ⁰¹⁾	C - t	C O U n	COUN: counter , TIME: timer	-
C1-2 Input operation mode ⁰¹⁾	i n	U d - C	UD-C: phase different input, UP, UP-1, UP-2, DN, DN-1, DN-2, UD-A: command input, UD-B: individual input	-
C1-3 Output operation mode ⁰¹⁾	o U t . n	F	[Preset setting model] F, N, C, R, K, P, Q, A, S*, T*, D*	*C1-2 input operation mode: UD-A, UD-B, UD-C
C1-4 Indication mode ⁰¹⁾	d S P . n	t o t A L	[Indicator model] HOLD, TOTAL • HOLD : You can set the PRESET value.	C1-2 input operation mode: UP, UP-1, UP-2, DN, DN-1, DN-2
C1-5 Max. counting speed ⁰¹⁾	C P S	3 0	30, 1K, 5K, 10K, 1 cps • Max. counting speed is when duty ratio of INA or INB input signal is 1:1. It is applied for INA, or INB input as same.	C1-3 output operation mode ⁰²⁾
C1-6 OUT2 output time ⁰¹⁾⁰³⁾	o U t 2	H o L d	[2-stage preset setting model] 0.01 to 99.99 sec, Hold	C1-3 output operation mode: C, R, K, P, Q, A ⁰⁴⁾
C1-7 OUT1 output time ⁰¹⁾⁰³⁾	o U t 1	0 0 . 1 0	[2-stage preset setting model] 0.01 to 99.99 sec, Hold • When 10 ¹ digit is flashing, press [◀] key once and Hold appears.	C1-3 output operation mode: F, N, C, R, K, P, Q, A ⁰⁴⁾
C1-8 OUT output time ⁰¹⁾⁰³⁾	o U t . t	H o L d	[1-stage preset setting model] 0.01 to 99.99 sec, Hold	C1-3 output operation mode: C, R, K, P, Q, A ⁰⁴⁾
C1-9 Counting value / preset value decimal point ⁰¹⁾	d P	- - - - -	[6 digit model] ----- [4 digit model] ----	-
C1-10 Min. RESET time	r s t	2 0	1, 20, ms	-
C1-11 Input logic	S i G	n P n	NPN, PNP • Set the same as settings of input logic selection switch.	-
C1-12 Prescale decimal point ⁰¹⁾⁰⁵⁾	S c . d P	- . - - - -	[6 digit model] ----- [4 digit model] ----	-
C1-13 Prescale value ⁰¹⁾	S c L	1 0 0 0 0 0	[6 digit model] 0.00001 to 99999.9 [4 digit model] 1 0 0 0 0.001 to 999.9	-
C1-14 Start Point value ⁰¹⁾⁰⁶⁾	S t r t	0 0 0 0 0 0	[6 digit model] 0.00000 to 999999 [4 digit model] 0 0 0 0 0.000 to 9999	C1-2 input operation mode: UD-C, UP, UP-1, UP-2, UD-A, UD-B
C1-15 Memorize counting value	d R t R	C L r	CLR: Resets counting value when power is off. REC: Memorizes counting value at the moment of power off. (memory retention)	-
C1-16 Key lock	L o C K	L o F F	L.OFF: Unlock key LOCK, key LOCK indicator OFF LOC.1: Locks [RST] key, key LOCK indicator ON LOC.2: Locks [◀], [▼], [▲] key, key LOCK indicator ON LOC.3: Locks [RST], [◀], [▼], [▲] key, key LOCK indicator ON	-

01) When the setting value of the parameter is changed, all outputs are OFF and reset the current value when returning to the RUN mode.

02) C1-3 Output operation mode: in case of D, 1, 30, 1k cps selectable.
C1-5 Max. counting speed: 5k, 10k cps & C1-3 Output operation mode: When D is set, the max. counting speed is automatically changed to 30 cps.

03) In case of 1-stage preset model, C1-7 OUT1 output time is not displayed, C1-6 OUT2 output time is displayed as OUT.T.

04) For other output operation modes, Hold is fixed.

05) It can not be set smaller than the digits of C1-9 Counting value / preset value decimal point.

06) The setting range is connected to the C1-9 Counting value / preset value decimal point.

Parameter 1 group (timer)

Parameter	Mark	Defaults	Setting range	Display condition
T1-1 Counter / timer ⁰¹⁾	C - t	C O U n	COUN: counter, TIME: timer	-
T1-2 Time range ⁰¹⁾	S E C	-	Refer to the table below. ⁰²⁾	-
T1-3 UP / DOWN mode ⁰¹⁾	U - d	U P	UP: 0 → setting time DN: setting time → 0	-
T1-4 Indication mode ⁰³⁾	d S P n	t o t R L	[Indicator model] TOTAL, HOLD, ONT.D: On time display • HOLD, ONT.D : You can set the PRESET value.	-
T1-5 Memorize counting value	d R t R	C L r	[Indicator model] CLR: Resets counting value when power is off. REC: Memorizes counting value at the moment of power off. (memory retention)	-
T1-6 Output operation mode ⁰¹⁾	o U t n	o n d	OND, OND.1, OND.2, FLK, FLK.1, FLK.2, INT, INT.1, INT.2 ⁰³⁾ , OFD, NFD, NFD.1, INTG	-
T1-7 OUT2 output time ⁰¹⁾	o U t 2	H o l d	[2-stage preset setting model] 0.01 to 99.99 sec, Hold • When 10 ¹ digit is flashing, press [◀] key once and Hold appears.	T1-6 output operation mode ⁰⁴⁾
T1-8 OUT1 output time ⁰¹⁾	o U t 1	0 0 . 1 0	[2-stage preset setting model] 0.01 to 99.99 sec, Hold • When 10 ¹ digit is flashing, press [◀] key once and Hold appears.	
T1-9 OUT output time ⁰¹⁾	o U t t	H o l d	[1-stage preset setting model] 0.01 to 99.99 sec, Hold • When 10 ¹ digit is flashing, press [◀] key once and Hold appears.	-
T1-10 Input logic	S i G	n P n	NPN, PNP • Set the same as settings of input logic selection switch.	-
T1-11 Input signal time	i n t	2 0	1, 20 ms • CTS / CTY : min. signal width of INA, INH, RESET signal • CTM : min. signal width of INA, RESET, INHIBIT, BATCH RESET signal	-
T1-12 Key lock	L o c k	L o F F	L.OFF: Unlock key LOCK, key LOCK indicator OFF LOC.1: Locks [RST] key, key LOCK indicator ON LOC.2: Locks [◀], [▼], [▲] key, key LOCK indicator ON LOC.3: Locks [RST], [◀], [▼], [▲] key, key LOCK indicator ON	-

01) When the setting value of the parameter is changed, all outputs are OFF and reset the current value when returning to the RUN mode

02) [6-digit model] setting range

Counting value display part	SEC (defaults)	SEC	SEC	SEC	M S	M S
Setting display part	999.999	9999.99	99999.9	999999	9959.99	99959.9
Range	0.001s to 999.999s	0.01s to 9999.99s	0.1s to 99999.9s	1s to 999999s	0.01s to 99m59.99s	0.1s to 999m59.9s

Counting value display part	M S	MIN	MIN	H M S	H M	HOURL
Setting display part	999959	99999.9	999999	995959	999959	99999.9
Range	1s to 9999m59s	0.1m to 99999.9m	1m to 999999m	1m to 99h59m59s	1m to 9999h59m	0.1h to 99999.9h

[4-digit model] setting range

Counting value display part	SEC (defaults)	SEC	SEC	SEC	M S	MIN	MIN	H M	HOURL
Setting display part	9.999	99.99	999.9	9999	9959	999.9	9999	9959	9999
Range	0.001s to 9.999s	0.01s to 99.99s	0.1s to 999.9s	1s to 9999s	0.1m to 99m59s	1m to 999.9m	1m to 9999m	1m to 99h59m	1h to 9999h

03) Appears for 2-stage preset model only

04) In case of T1-6 Output operation mode: FLK.1, FLK.2, INTG, or T1-6 Output operation mode of 1-stage preset model: OND, OND.1, OND.2, T1-8 OUT1 output time is not displayed, T1-7 OUT2 output time is displayed as OUT.T.

Parameter 2 group (communication)

• Only for RS485 communication model.

Parameter	Mark	Defaults	Setting range	Display condition
2-1 Comm. address	A d d r	0 0 1	1 to 127 • Do not set the same address during multi-comm.	-
2-2 Comm. speed	b P S	9 6	24: 2,400, 48: 4,800, 96: 9,600, 192: 19,200, 384: 38,400 bps	-
2-3 Parity bit	P r e Y	n o n E	NONE, EVEN, ODD	-
2-4 Stop bit	S t P	2	1, 2 bit	-
2-5 Response waiting time	r s y t	2 0	16 to 99 ms	2-2 Comm. speed: 24
			8 to 99 ms	2-2 Comm. speed: 48
			5 to 99 ms	2-2 Comm. speed: 96, 192, 384
2-6 Comm. write	C o n W	E n A	ENA: enable, DISA: disable	-

Output Operation Mode

For the detailed timing chart for operation output mode, refer to the manual.

Input Connections

- Input: INA, INB / INH, RESET, INHIBIT, BATCH RESET
- Max. counting speed in the contact input: 1 or 30 cps setting (counter)

No-voltage (NPN) input

Solid-state input

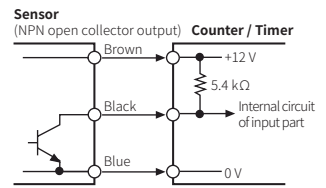
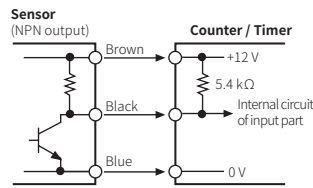

Contact input

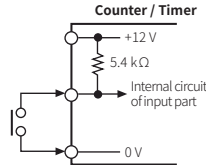

Voltage (PNP) input

Solid-state input

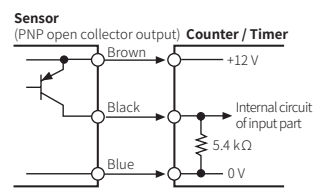
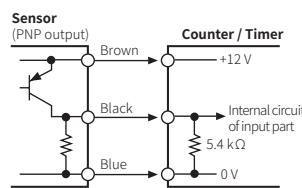

Contact input

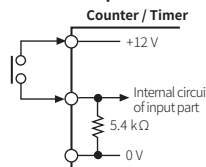

Output Connections

Solid-state output

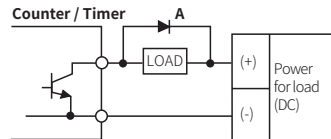

A: When using inductive load (relay etc.), surge absorber (diode, varistor etc.) must be connected between both sides of the load.

Contact output

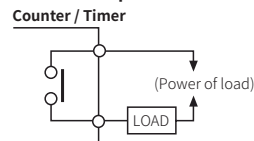

Description of Function

Switching display in setting display part

1-stage preset value and 2-stage preset value are displayed each time when pressing [MD] key in 2-stage preset model.

- In timer, it is available for output operation mode: OND, OND.1, OND.2 only.

BATCH counter

Counting value display part: BATCH counter value, setting display part: BATCH counter setting value is displayed.

In counter operation, count the number of reaching value of CT6M-1P□□ to preset value, and CT6M-2P□□ to 2-stage preset value.

In timer operation, count the number of reaching setting time.

- Output operation mode: in case of FLK, count the number of reaching T.off setting time and T.on setting time

BATCH counter operation

BATCH counting value is increasing until BATCH reset signal applied. BATCH counting value will be circulated when it is over 999999.

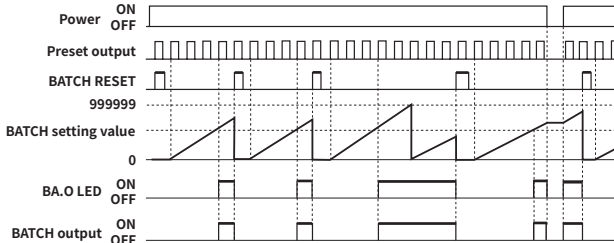

BATCH RESET

If pressing [RST] key on the front side or the signal to BATCH RESET terminal on the back side panel, BATCH counting value will be reset and BATCH output maintains OFF state.

- When selecting voltage input (PNP), short terminals 10 and 14, or when selecting no-voltage input (NPN), short terminals 11 and 14 to reset.

Applications

[counter]

In case, put 5 products in a box then pack the boxes when they reaches to 200.

- PRESET = 5, BATCH = 200

: When the count value of counter reaches to the preset value 5, the control output (OUT) will be on, and at this time the count value of the BATCH counter will be increased by 1.

The control box which is received the control output (OUT) repeatedly controls conveyor to move the full box and to place the next empty box for standby.

When the BATCH counting value reaches to 200, BATCH output will be ON. Then the control box stops conveyor and provides a control signal for packing.

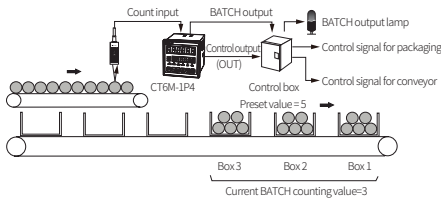

[timer]

Fills milk into the bottle for 3 sec when 500 bottles are filled

- Setting time = 3 sec, BATCH = 500

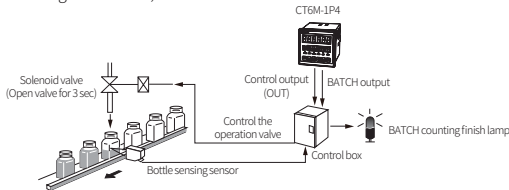

Start Point (counter)

This function is that start at initial value set at Start Point value.

- When reset is applied, the present value is initialized to Start Point value.
- After Count Up at output operation mode: C, R, P, Q, present value starts at Start Point value.

Prescale (counter)

This function is to set and display calculated unit for actual length, liquid, position, etc. It is called 'prescale value' for measured length, liquid, or position, etc per 1 pulse.

- When moving L, the desired length to be measured, and P, the number of pulses per 1 revolution of a rotary encoder, occurs, prescale value is L/P.

Application

Diameter of pulley connected with encoder is 22 mm, the number of pulses by 1 rotation of encoder is 1,000

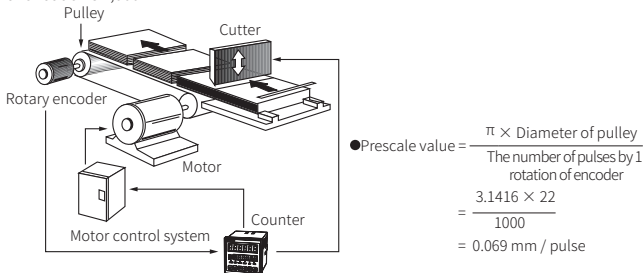

- Select decimal point: ----, prescale decimal point: ---, --- and set prescale value: 0.069, it is available to control conveyor position by 0.1 mm unit.

Counter Operation

Input operation mode

Rising: / Falling:

Mode	Counting chart ⁽⁰¹⁾	Operation description
UP		<ul style="list-style-type: none"> INA: Counting input INB: No counting input INA: No counting input INB: Counting input
UP - 1		<ul style="list-style-type: none"> When INA input signal is rising, it counts. INA: Counting input INB: No counting input
UP - 2		<ul style="list-style-type: none"> When INA input signal is falling, it counts. INA: Counting input INB: No counting input
DN		<ul style="list-style-type: none"> INA: Counting input INB: No counting input INA: No counting input INB: Counting input
DN - 1		<ul style="list-style-type: none"> When INA input signal is rising, it counts. INA: Counting input INB: No counting input
DN - 2		<ul style="list-style-type: none"> When INA input signal is falling, it counts. INA: Counting input INB: No counting input
UD-A ⁽⁰²⁾ : command input		<ul style="list-style-type: none"> INB: In case of L, count up INB: In case of H, count down INA: Counting input INB: Counting command input
UD-B ⁽⁰²⁾ : individual input		<ul style="list-style-type: none"> When INA and INB input signals are rising at the same time, it maintains previous counting value. INA: Up counting input INB: Down counting input
UD-C ⁽⁰²⁾ : phase different input		<ul style="list-style-type: none"> When connecting encoder output A, B phase with counter input INA and INB, set input operation mode as UD-C.

01) A should be over min. signal width, B is over 1/2 of min. signal width. If the signal is smaller than these widths, it may cause counting error (± 1).

02) If the present value is out of the preset setting range, the counting value is reset as 0 and the control output does not operate. RESET to initialize the display value and output status.

- Min. signal width by counting speed

Counting speed [cps ⁽⁰¹⁾]	Min. signal width [ms]
1	500
30	16.7
1 k	0.5
5 k	0.1
10 k	0.05

01) 1 cps = 1 Hz

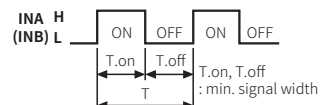

- H, L of the counting chart

Input logic Character	Voltage input (PNP)	No-voltage input (NPN)
H	5 - 30 VDC	Short
L	0 - 2 VDC	Open

Output operation mode

Out output of 1-stage preset model operates as same with the OUT2 output of 2-stage preset model.

OUT1 output of 2-stage preset model is operated One-shot output or retained (Hold) output. (except S, T, D of input operation mode)

OUT1 output could be set to 0 in all modes and 0 value output turns ON.

OUT2 output could not set to 0 in output operation mode: C, R, P, Q.

• Output type

One-shot output

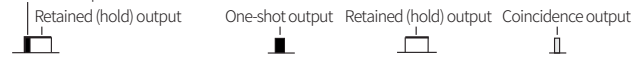

Mode	Output operation description in input operation mode		
	UP, UP - 1/2	DN, DN - 1/2	UD - A/B/C
F			
	After count-up, counting display value increases or decreases until RESET signal is applied and retained (hold) output is maintained.		
N			
	After count-up, counting display value and retained (hold) output are maintained until RESET signal is applied.		
C			
	When count-up, counting display value will be RESET and count simultaneously. OUT1 retained (hold) output will be OFF after OUT2 One-shot output time. • The One-shot output time of OUT1 is regardless of OUT2.		
R			
	After count-up, counting value display is RESET after One-shot output time of OUT2 and it counts simultaneously. OUT1 retained (hold) output will be OFF after OUT2 One-shot output time. • The One-shot output time of OUT1 is regardless of OUT2.		
K			
	After count-up, counting display value increases or decreases until RESET signal is applied. OUT1 retained (hold) output will be OFF after OUT2 One-shot output time. • The One-shot output time of OUT1 is regardless of OUT2.		
P			
	After count-up, counting display value is maintained while OUT2 output is on. Counting value is internally RESET and counts simultaneously. When OUT2 is OFF, displays counting value while OUT2 is ON, and it increases or decreases. OUT1 retained (hold) output will be OFF after OUT2 One-shot output time. • The One-shot output time of OUT1 is regardless of OUT2.		
Q			
	After count-up, counting display value increases or decreases during OUT2 One-shot time. OUT1 retained (hold) output will be OFF after OUT2 One-shot output time. • The One-shot output time of OUT1 is regardless of OUT2.		
A			
	After count-up, counting display value and OUT1 retained (hold) output are maintained until RESET input is applied. • The One-shot output time of OUT1 is regardless of OUT2.		

Mode	Output operation description in input operation mode	
	UD - A/B/C	
S		OUT1 / 2 keep ON state in following condition: Counting display value \geq 1 / 2-stage preset value
		OUT1 output is off: counting display value \geq 1-stage preset value. OUT1 keeps ON state when 1-stage preset value = 0. OUT2 keeps ON state in following condition: counting display value \geq 2-stage preset value
D		OUT1 / 2 are ON only when counting display value = 1 / 2-stage preset value. • When setting 1 kcps for counting speed, solid state contact output should be used. When using contact output, it is difficult to execute normal output operation due to contact reaction time.

Counter operation of indicator model

Mode	Counting chart and output operation description	
	Input operation mode = UP, UP - 1/2	Input operation mode = DN, DN - 1/2
TOTAL		
	Counting value increases or decreases until RESET input is applied. When input is over max. / min. counting value, it displays 0. When applying RESET input, displays 0. When applying RESET input, displays 999999.	
HOLD		
	Counting value increases or decreases until RESET input is applied. When input is reaching PRESET, the display value is hold. When applying RESET input, displays 0. When input is reaching 0, the display value is hold. When applying RESET input, displays PRESET value.	
Mode	Input operation mode = UD - A/B/C	
-		

Output operation for other conditions

01. Output operation for the relation of Start Point value, PRESET value

- Output operation description: 2-stage preset value > Start Point = 1-stage preset value
OUT1 occurs when RESET OFF.
- Output operation description: 2-stage preset value > Start Point > 1-stage preset value

Mode	Counting chart and output operation description		
	Input operation mode = UP, UP - 1/2	Input operation mode = UD - A/B/C	
F			
	OUT1 does not execute. OUT2 occurs when reaching 2-stage preset value. Count down and OUT1 occurs when reaching 1-stage preset value.		
02. 1-stage preset value \geq 2-stage preset value (input operation mode: DN, DN-1, DN-2)			
• Output operation description: 1-stage preset value > 2-stage preset value			
• Output operation description: 1-stage preset value = 2-stage preset value			
Mode	Input operation mode = DN, DN - 1/2	Mode	Input operation mode = DN, DN - 1/2
F		F	
	OUT1 does not execute.		OUT1 occurs when RESET OFF.

Timer Operation

Output operation mode

Power reset: There is no memory retention.

Initialize the display value and output state when power on again.

Power hold: There is memory retention.

Memorize the display value at the moment of power off, restoring the memorized display value and output state when power on again.

Output type



Mode	Time chart and output operation description
OND (Signal on delay)	<p>POWER INA (START) INH (INHIBIT) RESET</p> <p>Setting time 2 Setting time 1 0</p> <p>Up Display Down Setting time 2 Setting time 1 0</p> <p>OUT1 OUT2</p> <p>• Power reset Time starts when INA input is ON. Time is RESET during INA input is OFF. When INA input is ON: Power on time start operates, Reset off time start operates.</p> <p>INA OUT1 OUT2 (OUT)</p> <p>T1 = setting time 1 T2 = setting time 2</p>
	<p>POWER INA (START) INH (INHIBIT) RESET</p> <p>Setting time 2 Setting time 1 0</p> <p>Up Display Down Setting time 2 Setting time 1 0</p> <p>OUT1 OUT2</p> <p>• Power reset Time starts when INA input is ON. When INA input is ON: Power on time start operates, Reset off time start operates. Only the first signal is valid in case INA input signal is repeatedly applied.</p> <p>INA OUT1 OUT2 (OUT)</p> <p>T1 = setting time 1 T2 = setting time 2</p>
OND.2 (Power on delay)	<p>POWER INA (START) INH (INHIBIT) RESET</p> <p>Setting time 2 Setting time 1 0</p> <p>Up Display Down Setting time 2 Setting time 1 0</p> <p>OUT1 OUT2</p> <p>t a t-a</p> <p>• Power hold Power on time start (no INA function) Time is RESET when RESET is ON. Time starts when RESET ON → OFF.</p> <p>POWER OUT1 OUT2 (OUT)</p> <p>T1 = setting time 1 T2 = setting time 2</p> <p>HOLD</p>
	<p>POWER INA (START) INH (INHIBIT) RESET</p> <p>Setting time 2 Setting time 1 0</p> <p>Up Display Down Setting time 2 Setting time 1 0</p> <p>OUT1 OUT2</p> <p>t a t-a</p> <p>• Power hold Power on time start (no INA function) Time is RESET when RESET is ON. Time starts when RESET ON → OFF.</p> <p>POWER OUT1 OUT2 (OUT)</p> <p>T1 = setting time 1 T2 = setting time 2</p> <p>HOLD</p>
FLK (Flicker)	<p>POWER INA (START) INH (INHIBIT) RESET</p> <p>T.off setting time T.on setting time 0</p> <p>Up Display Down T.off setting time T.on setting time 0</p> <p>OUT2 (OUT)</p> <p>T.off T.on T.a T.b T.on T.off T.on</p> <p>• Power reset Time starts when INA input is ON. When INA input is ON: Power on time start operates, Reset off time start operates. Output turns OFF from INA input turn ON to T.off setting time, turns ON for the T.on setting time repeatedly. In case of using the contact output, min. setting time must be set over 100 ms.</p> <p>POWER INA OUT2 (OUT)</p> <p>T.off T.on T.off</p> <p>Ta + Tb = T.off T.off, T.on must be set individually</p>
	<p>POWER INA (START) INH (INHIBIT) RESET</p> <p>T.off setting time T.on setting time 0</p> <p>Up Display Down T.off setting time T.on setting time 0</p> <p>OUT2 (OUT)</p> <p>T.off T.on T.a T.b T.on T.off T.on</p> <p>• Power reset Time starts when INA input is ON. When INA input is ON: Power on time start operates, Reset off time start operates. Output turns OFF from INA input turn ON to T.off setting time, turns ON for the T.on setting time repeatedly. In case of using the contact output, min. setting time must be set over 100 ms.</p> <p>POWER INA OUT2 (OUT)</p> <p>T.off T.on T.off</p> <p>Ta + Tb = T.off T.off, T.on must be set individually</p>

Mode	Time chart and output operation description
FLK.1 (Flicker 1)	<p>POWER INA (START) INH (INHIBIT) RESET</p> <p>Setting time 0</p> <p>Up Display Down Setting time 0</p> <p>OUT2 (OUT)</p> <p>• Power reset, retained (hold) output Time starts when INA input is ON. When INA input is ON: Power on time start operates, Reset off time start operates. Only the first signal is valid in case INA input signal is repeatedly applied. In case of using the contact output, min. setting time must be set over 100 ms.</p> <p>POWER INA OUT2 (OUT)</p> <p>T = setting time</p>
	<p>POWER INA (START) INH (INHIBIT) RESET</p> <p>Setting time 0</p> <p>Up Display Down Setting time 0</p> <p>OUT2 (OUT)</p> <p>• Power reset, retained (hold) output Time starts when INA input is ON. When INA input is ON: Power on time start operates, Reset off time start operates. Only the first signal is valid in case INA input signal is repeatedly applied. In case of using the contact output, min. setting time must be set over 100 ms.</p> <p>POWER INA OUT2 (OUT)</p> <p>T = setting time</p>
FLK.2 (Flicker 2)	<p>POWER INA (START) INH (INHIBIT) RESET</p> <p>Setting time 0</p> <p>Up Display Down Setting time 0</p> <p>OUT2 (OUT)</p> <p>• Power reset, One-shot output Time starts when INA input is ON. When INA input is ON: Power on time start operates, Reset off time start operates. Only the first signal is valid in case INA input signal is repeatedly applied. In case of using the contact output, min. setting time must be set over 100 ms.</p> <p>POWER INA OUT2 (OUT)</p> <p>T = setting time</p>
	<p>POWER INA (START) INH (INHIBIT) RESET</p> <p>Setting time 0</p> <p>Up Display Down Setting time 0</p> <p>OUT2 (OUT)</p> <p>• Power reset, One-shot output Time starts when INA input is ON. When INA input is ON: Power on time start operates, Reset off time start operates. Only the first signal is valid in case INA input signal is repeatedly applied. In case of using the contact output, min. setting time must be set over 100 ms.</p> <p>POWER INA OUT2 (OUT)</p> <p>T = setting time</p>
INT (Interval)	<p>POWER INA (START) INH (INHIBIT) RESET</p> <p>Setting time 0</p> <p>Up Display Down Setting time 0</p> <p>OUT2 (OUT)</p> <p>• Power reset Control output turns ON and time starts when INA signal turns ON. Time is RESET when INA input is OFF. When INA input is ON: Power on time start operates, Reset off time start operates. When reaching the setting time, Auto reset is activated. Control output is ON when Time is progressing.</p> <p>POWER INA OUT2 (OUT)</p> <p>T = setting time</p>
	<p>POWER INA (START) INH (INHIBIT) RESET</p> <p>Setting time 0</p> <p>Up Display Down Setting time 0</p> <p>OUT2 (OUT)</p> <p>• Power reset Control output turns ON and time starts when INA signal turns ON. Time is RESET when INA input is OFF. When INA input is ON: Power on time start operates, Reset off time start operates. When reaching the setting time, Auto reset is activated. Control output is ON when Time is progressing.</p> <p>POWER INA OUT2 (OUT)</p> <p>T = setting time</p>

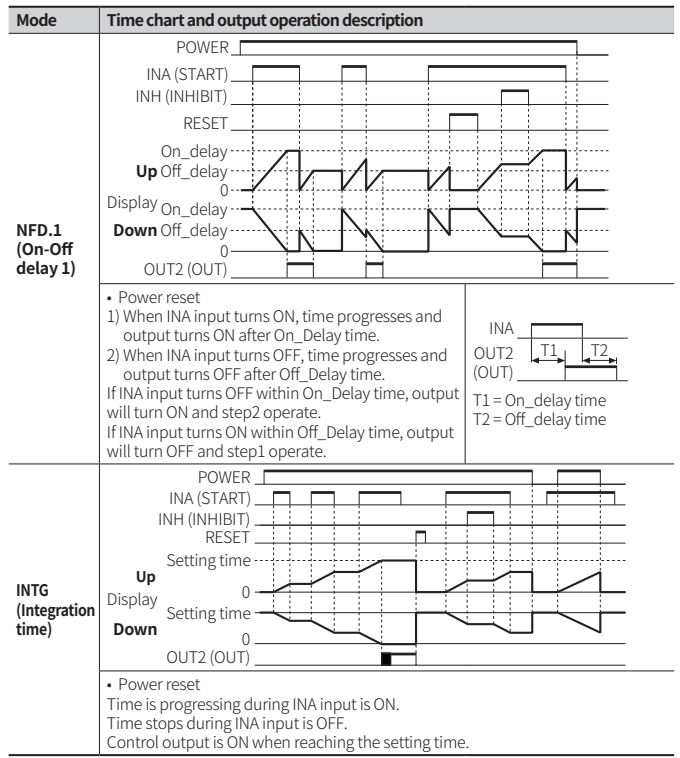
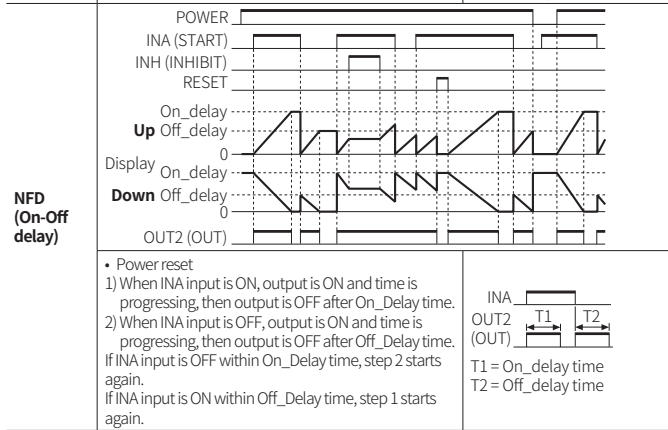
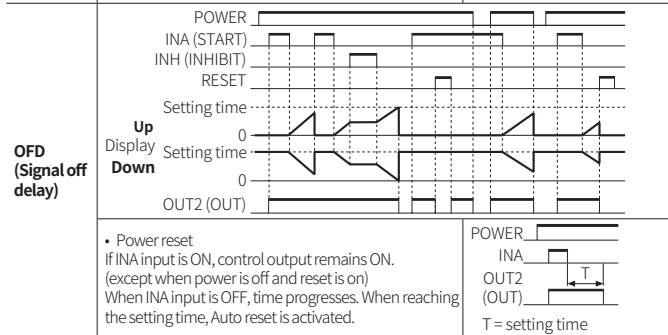
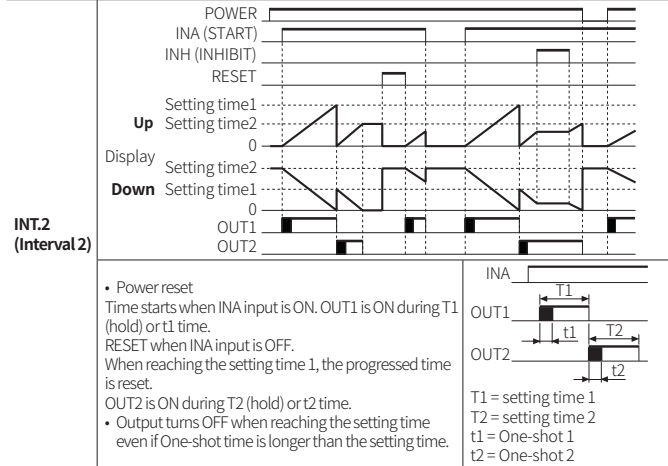
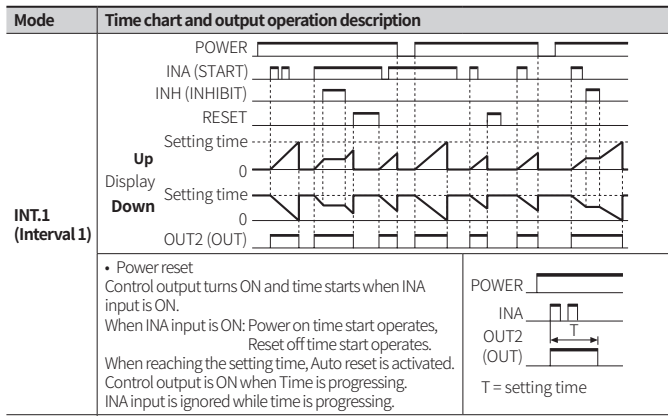

■ Timer operation of indicator model

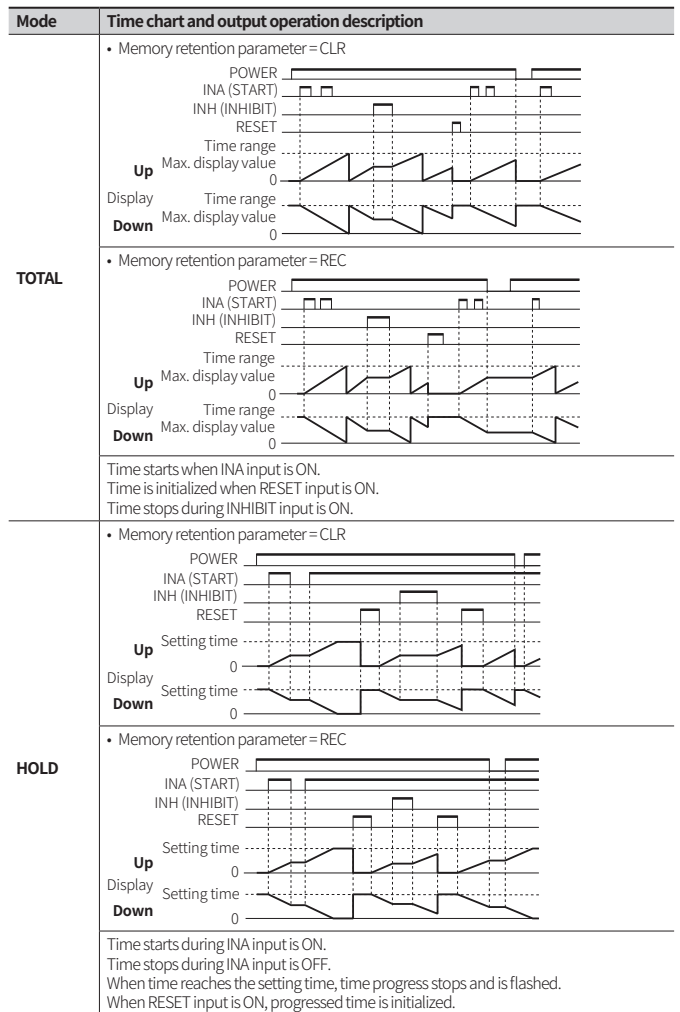

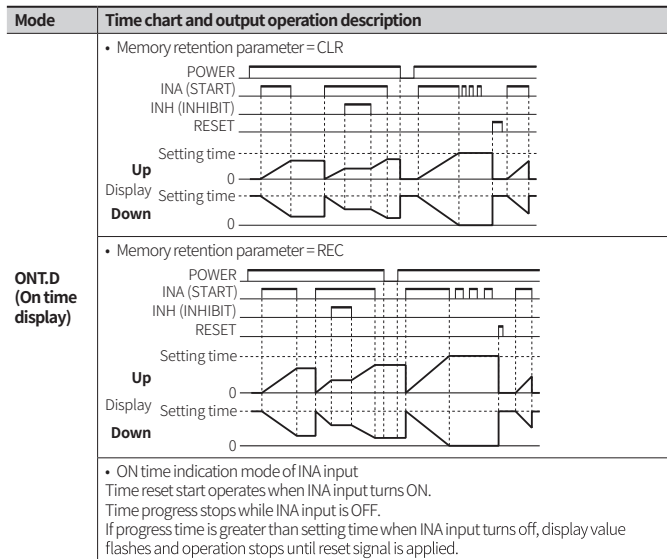

0 time setting

- It is available to set in output operation mode: OND, OND.1, OND.2, NFD, NFD.1.
- Output type

One-shot output

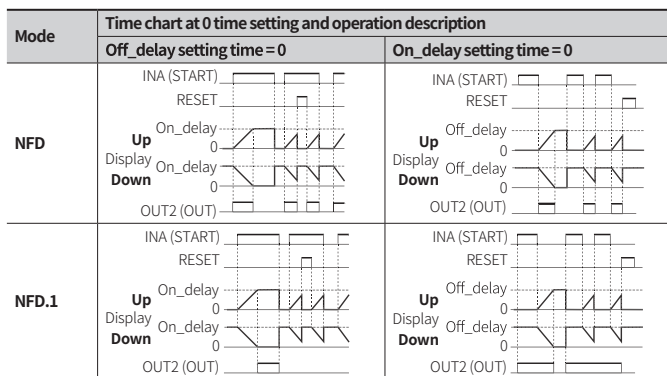
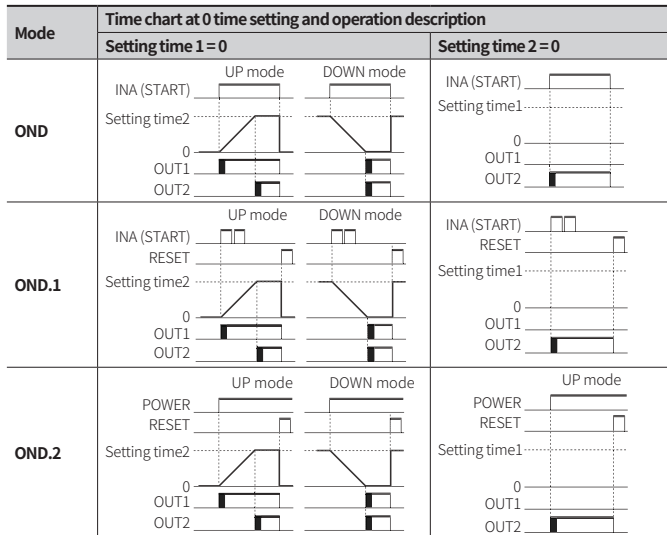
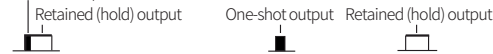

Setting when 1-stage preset value > 2-stage preset value

- Output operation mode: OND, OND.1, OND.2
- UP mode: OUT1 output does not turn ON.
- DOWN mode: OUT1 output does not turn ON.
- In 1-stage preset value = 2-stage preset value, when Start signal is applied, OUT1 turns ON immediately.

Segment Table

The segments displayed on the product indicate the following meanings. It may differ depending on the product.

7 segment	11 segment	12 segment	16 segment
0	0	0	0
1	1	1	1
2	2	2	2
3	3	3	3
4	4	4	4
5	5	5	5
6	6	6	6
7	7	7	7
8	8	8	8
9	9	9	9
A	A	A	A
b	b	b	b
c	c	c	c
d	d	d	d
E	E	E	E
F	F	F	F
G	G	G	G
H	H	H	H