

Technical Data Sheet Photocoupler

Preliminary

Features:

- Current transfer ratio
(CTR:MIN.50% at IF =5mA ,VCE =5V)
- High isolation voltage between input and output (Viso=5000 V rms)
- Compact dual-in-line package
EL817L*:1-channel type
- Pb free

- UL approved (No. E214129)
- VDE approved (No. 132249)
- SEMKO approved (No. 0143133/01-03)
- NEMKO approved (No. P00102385)
- DEMKO approved (No. 310352-04)
- FIMKO approved (No. FI 16763A2)
- CSA approved (No. 1143601)
- BSI approved (No. 8592 / 8593)

- Options available:
 - Leads with 0.4"(10.16mm) spacing (M Type)
 - Leads bends for surface mounting (S Type)
 - Tape and Reel of Type I for SMD(Add"-TA" Suffix)
 - Tape and Reel of Type II for SMD(Add"-TB" Suffix)
 - The tape is 16mm and is wound on a 33cm reel
- The product itself will remain within RoHS compliant version.

EL817L Series

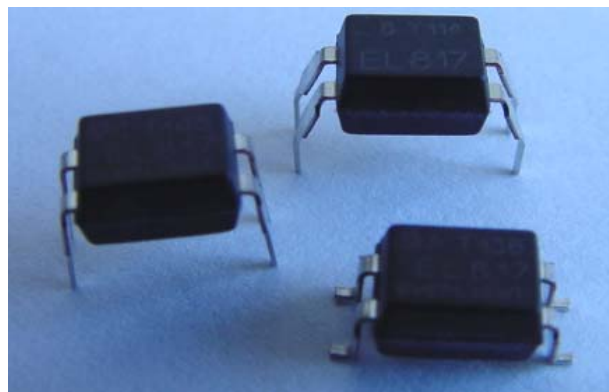

Description

The EL817 series contains a infrared emitting diode optically coupled to a phototransistor. It is packaged in a 4-pin DIP package and available in wide-lead spacing and SMD option.

Applications

- Computer terminals
- System appliances, measuring instruments
- Registers, copiers, automatic vending machines
- Cassette type recorder
- Electric home appliances, such as fan heaters, etc.
- Signal transmission between circuits of different potentials

Technical Data Sheet
Photocoupler

Preliminary

and impedances

EL817L Series

Device Selection Guide

Part. No.	Chip Material	
	IR	PT
EL817*	GaAs	Silicon

Package Dimensions

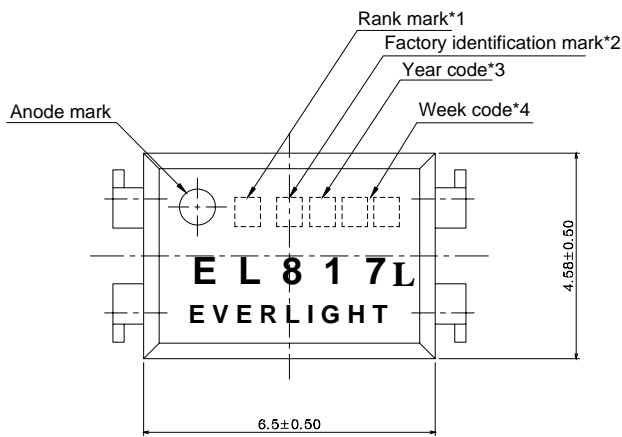

PIN NO. AND INTERNAL CONNECTION DIAGRAM

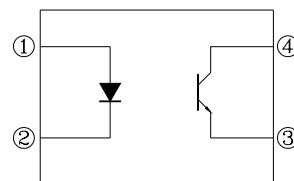

- 1. Anode
- 2. Cathode
- 3. Emitter
- 4. Collector

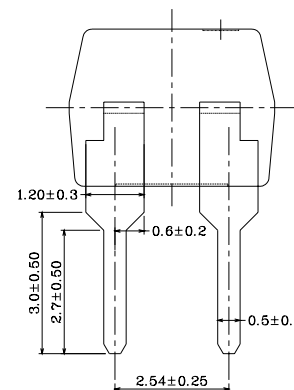
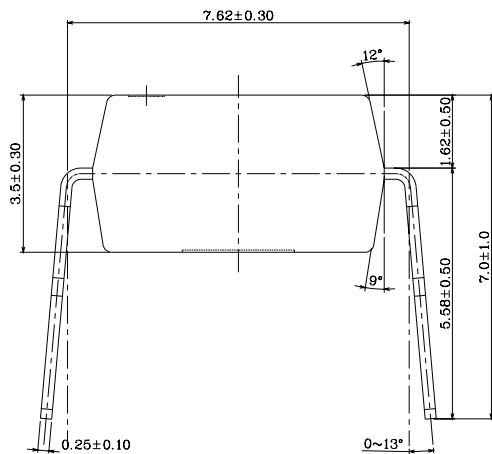

Technical Data Sheet
Photocoupler

Preliminary

EL817L Series

Package Dimensions

M Type

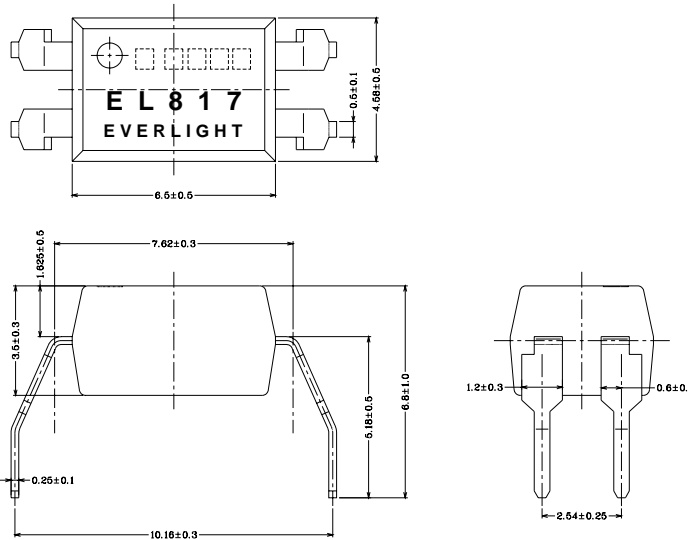

S Type

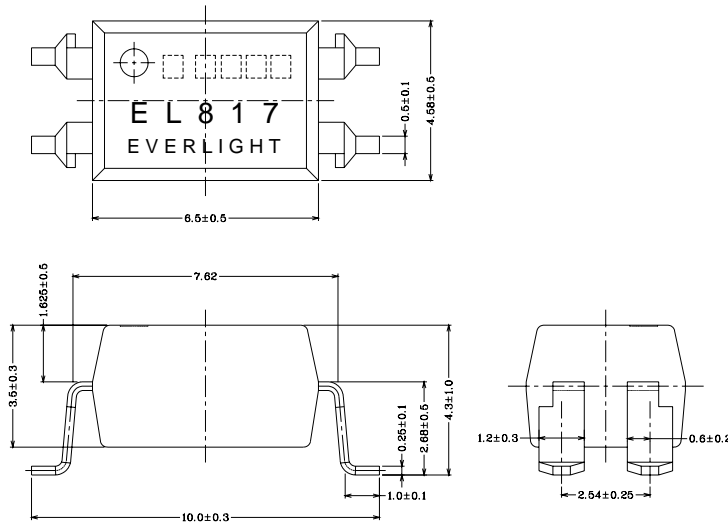

Notes:

1. Rank shall be or shall not be marked
2. Factory code shall be marked (T: Taiwan / C: China)
3. Year date code
4. 2-digit work week
5. All dimensions are in millimeters
6. Specifications are subject to change without notice

**Technical Data Sheet
Photocoupler**
Preliminary
EL817L Series
Absolute Maximum Ratings (Ta=25°C)

Parameter		Symbol	Rating	Unit
Input	Forward Current	I_F	80	mA
	Reverse Voltage	V_R	6	V
	Power Dissipation	P	150	mW
Output	Collector Power Dissipation	P_C	150	mW
	Collector Current	I_C	50	mA
	Collector-Emitter Voltage	V_{CEO}	35	V
	Emitter-Collector Voltage	V_{ECO}	6	V
Total Power Dissipation		P_{tot}	200	mW
*1 Isolation Voltage		Viso	5000	V rms
Operating Temperature		Topr	-55~+110	°C
Storage Temperature		Tstg	-55~+125	°C
*2 Soldering Temperature		Tsol	260	°C

*1 AC for 1 minute, R.H= 40~ 60%RH

-Isolation voltage shall be measured using the following method.

- (1) Short between anode and cathode on the primary side and between collector, emitter and base on the secondary side.
- (2) The isolation voltage tester with zero-cross circuit shall be used.
- (3) The waveform of applied voltage shall be a sine wave

*2 For 10 seconds

**Technical Data Sheet
Photocoupler**
Preliminary
EL817L Series
Electro-Optical Characteristics

(Ta=25°C)

Parameter		Symbol	Min.	Typ.	Max.	Unit	Condition
Input	Forward	V_F	-	1.2	1.4	V	$I_F=20\text{mA}$
	Reverse Current	I_R	-	-	10	μA	$V_R=4\text{V}$
	Terminal	C_t	-	30	250	pF	$V=0, f=1\text{kHz}$
Output	Collector Dark current	I_{CEO}	-	-	100	nA	$V_{CE}=20\text{V}$
	Collector-Emitter breakdown voltage	BV_{CEO}	80	-	-	V	$I_C=0.1\text{mA}$
Transfer Characteristics	Current Transfer ratio	CTR	50	-	600	%	$I_F=5\text{mA}, V_{CE}=5\text{V}$
	Collector-Emitter saturation voltage	$V_{CE(sat)}$	-	0.1	0.2	V	$I_F=20\text{mA}, I_C=1\text{mA}$
	Isolation resistance	R_{ISO}	5×10^{10}	10^{11}	-	Ω	DC500V, 40~60%R.H
	Floating capacitance	C_f	-	0.6	1.0	pF	$V=0, f=1\text{MHz}$
	Cut-off frequency	f_c	-	80	-	kHz	$V_{CE}=5\text{V}, I_C=2\text{mA}$ $R_L=100\Omega, -3\text{dB}$
	Rise time	t_r	-	4	18	μs	$V_{CE}=2\text{V}$ $I_C=2\text{mA}, R_L=100\Omega$

**Technical Data Sheet
Photocoupler**
Preliminary

	Fall time	t_f	-	3	18	EL817L Series US
--	-----------	-------	---	---	----	----------------------------

Supplement
Current Transfer Ratio CTR

Sub-Model No.	Rank mark	CTR (%)	Condition
EL817* note 1		50 to 600	$I_F = 5 \text{ mA}$ $V_{CE} = 5 \text{ V}$ $T_a = 25^\circ\text{C}$
EL817* (A)	A	80 to 160	
EL817* (B)	B	130 to 260	
EL817* (C)	C	200 to 400	
EL817* (D)	D	300 to 600	

Note1. The symbol “ * “ can be none or S or M by different leads form request

Note2. The symbol “ () ” can be CTR rank

Fig. 1 Forward Current vs. Ambient Temperature

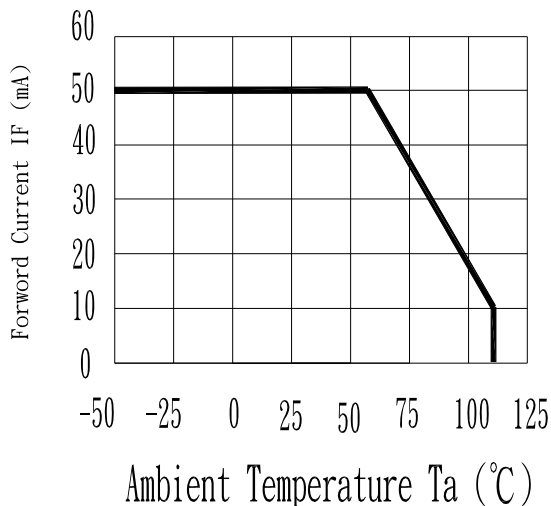
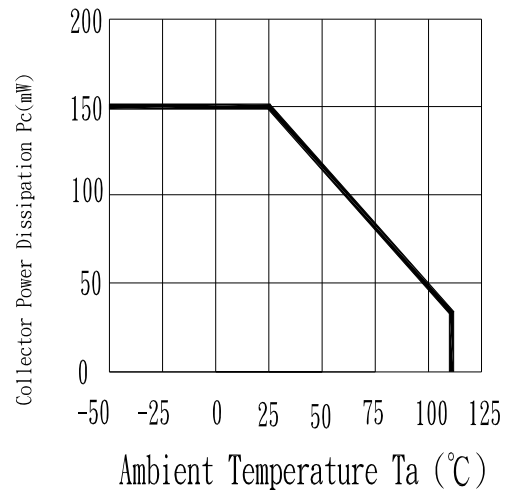

Fig.2 Collector Power Dissipation vs. Ambient Temperature



Technical Data Sheet
Photocoupler

Preliminary

EL817L Series

Fig. 3 Collector-emitter Saturation Voltage vs. Forward Current (Ta=25°C)

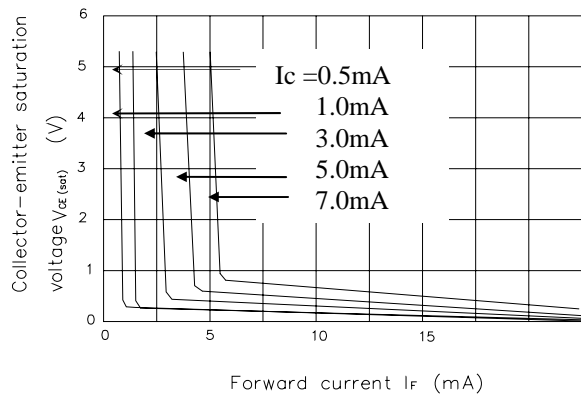
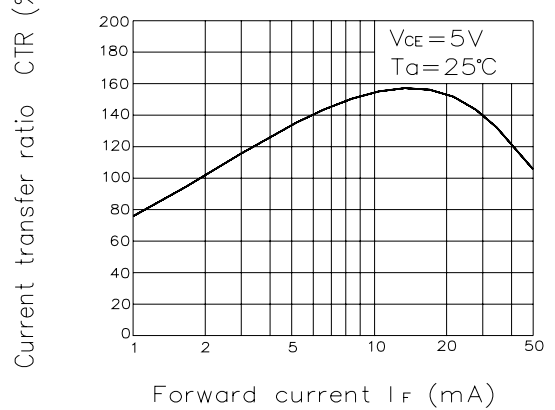

Fig.4 Current transfer Ratio vs. Forward Current



Fi

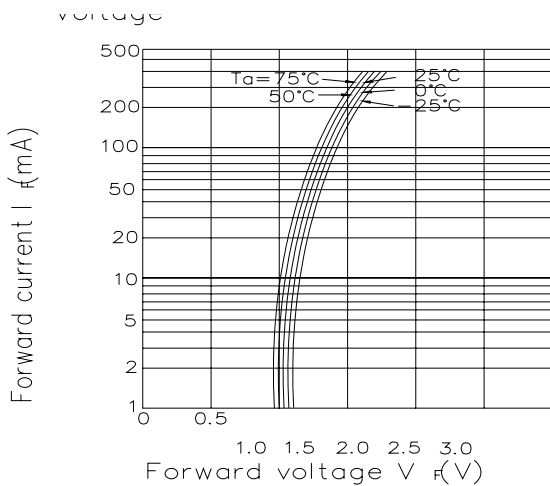

Fig.6 Collector Current vs. Collector-emitter Voltage (Ta=25°C)

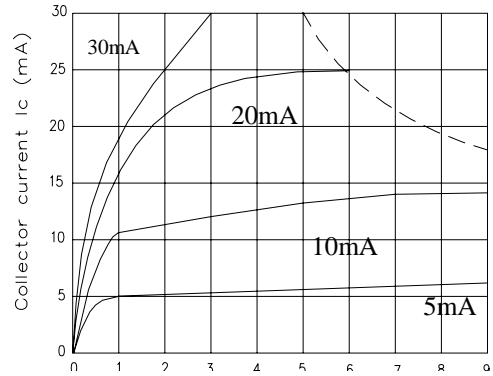

Fig.7 Relative Current Transfer Ratio vs. Ambient Temperature

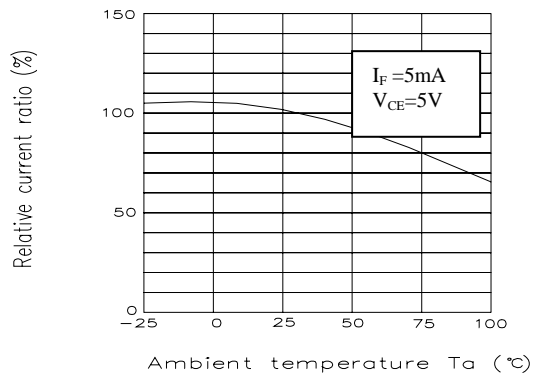
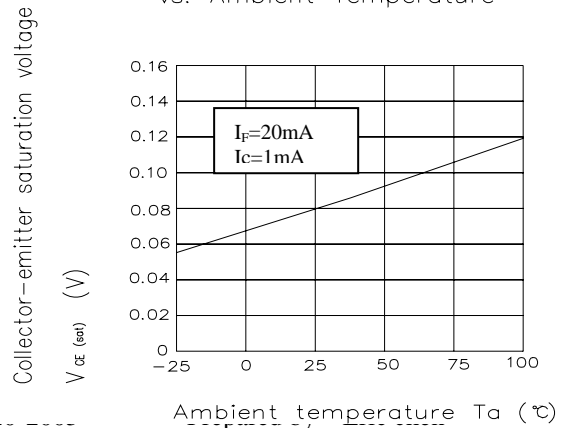

Fig.8 Collector-emitter Saturation Voltage vs. Ambient Temperature



Es

Device No :

Prepared date :

Ambient temperature T_a (°C)

Technical Data Sheet
Photocoupler

Preliminary

EL817L Series

Fig.9 Collector Dark Current vs. Ambient Temperature

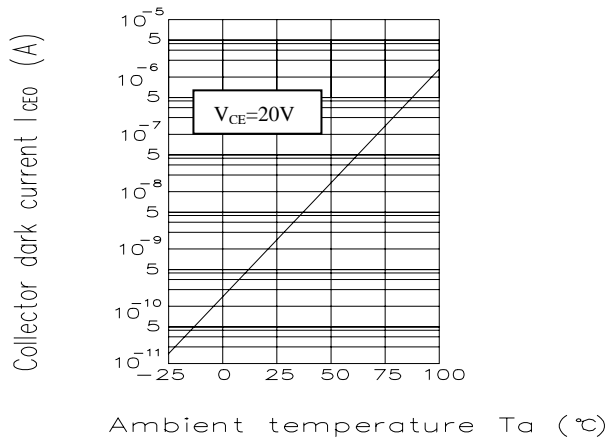

Fig.10 Response Time vs. Load Resistance

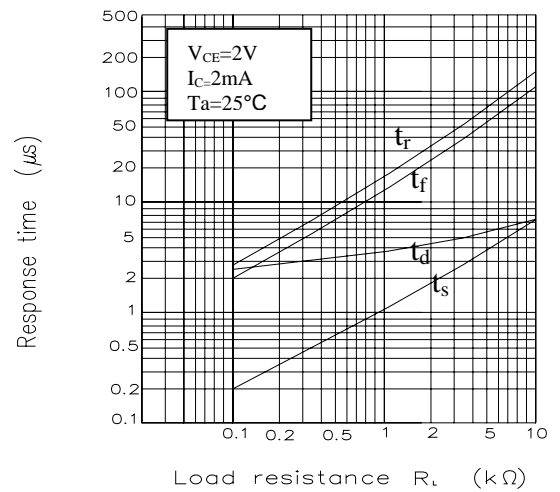
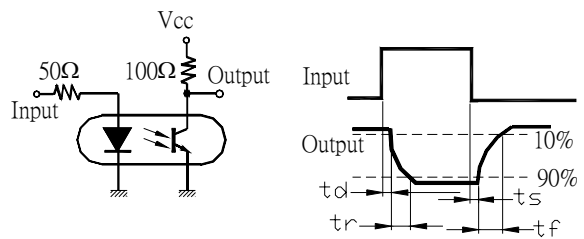
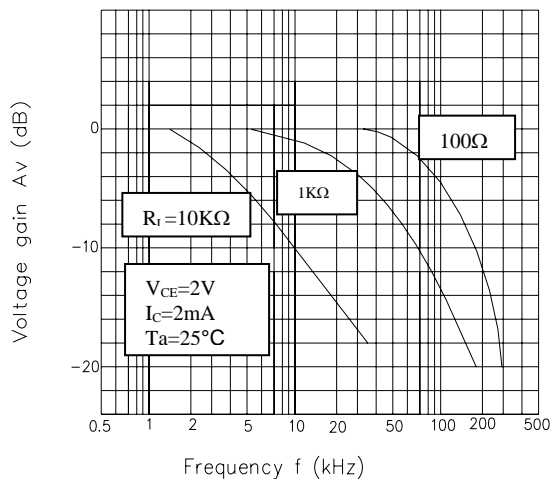

Fig.11 Frequency Response





RELIABILITY PLAN

- **The reliability of products shall be satisfied with items listed below.**

Confidence level : 90 % , LTPD : 10 %

**Technical Data Sheet
Photocoupler**
Preliminary

Classification	Test Item	Description & Condition	(Acc.) Sample	EL817L Series	
				Failure Criteria	Reference Standard
Endurance test	Operation Life *	Ta = 25 ± 3°C IR: If = 50 mA Pt: Pc = 130 mW (Vf=1.4v) , 1000 hrs	0 / 22	CTR shift > 1.2 Vf > U* 1.0 Ir > U* 1.0 Vce(sat) > U*1.0 Bvceo < L*1.0 Bveco < L*1.0 L :Low Spec.Limit U : Up Spec. Limit	MIL-S-750 : 1026 MIL-S-883 : 1005 JIS C 7021 : B-1
	High Temperature / High Humidity Reverse Bias (H3TRB)	Ta = 85 ± 3°C , Humi. = 85 % rh Pt: 80% * Vce (max rating) , 1000 hrs	0 / 22		JIS C 7021 : B-11
	High Temperature Reverse Bias (HTRB)	Ta = 105 ± 3°C Pt: 100% * Vce (Max rating) , 1000 hrs	0 / 22		JIS C 7021 : B-8
	Low Temperature Storage	Ta = -50 ± 3°C , 1000 hrs	0 / 22		JIS C 7021 : B-12
	High Temperature Storage	Ta = 125 ± 3°C , 1000 hrs	0 / 22		JIS C 7021 : B-10 MIL-S-883 : 1008
	Auto clamp	P = 15 PSIG , Ta = 121 °C , Humi. = 100 % rh , 48 hrs	0 / 22		JESD 22-A102-B
	Environmental Test	Temperature Cycling (Air to Air)	125°C ~ - 55 °C 30 ~ 30 min , 100 cycles		0 / 22
Thermal Shock (Liquid to Liquid)		125 ~ - 55°C t (dwell) = 5 min t (trans.) = 10 sec , 100 cycles	0 / 22	MIL-S-202 : 107D MIL-S-750 : 1051 MIL-S-883 :1011	
Solder Resistance		Ta = 260 ± 3°C t (dwell) = 10 ± 1 sec	0 / 22	MIL-S-750 : 2031 JIS C 7021 : A-1	
Solder Ability		Ta = 230 ± 3 °C t (dwell) = 5 ± 1 sec	0 / 22	MIL-S-883 : 2003 JIS C 7021 : A-2	

1. Tube Packing Specifications (For Dip & M Type)
1. Tube

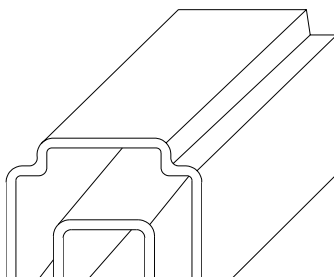
 Everlight
Device

<http://www.everlight.com>
Prepared date : 07-20-2005

 Rev 2
Page: 10 of 11
Prepared by : Eric chen



Technical Data Sheet
Photocoupler

Preliminary

EL817L Series

2. Inner Carton

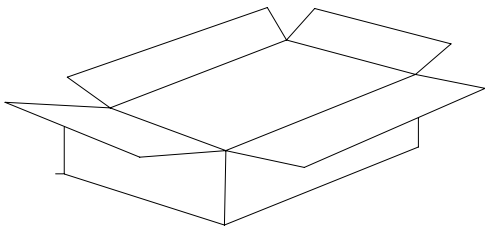

3. Outside Carton

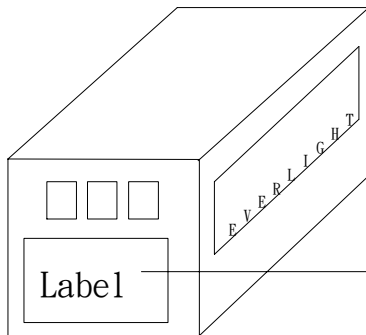

● Packing Quantity

- 1. 100 Pcs/ Per Tube
- 2. 25 Tubes / Inner Carton
- 3. 12 Inner Cartons / Outside Carton

1. Tape & Reel Packing Specifications

- 1. Tape & Reel (For S Type only)

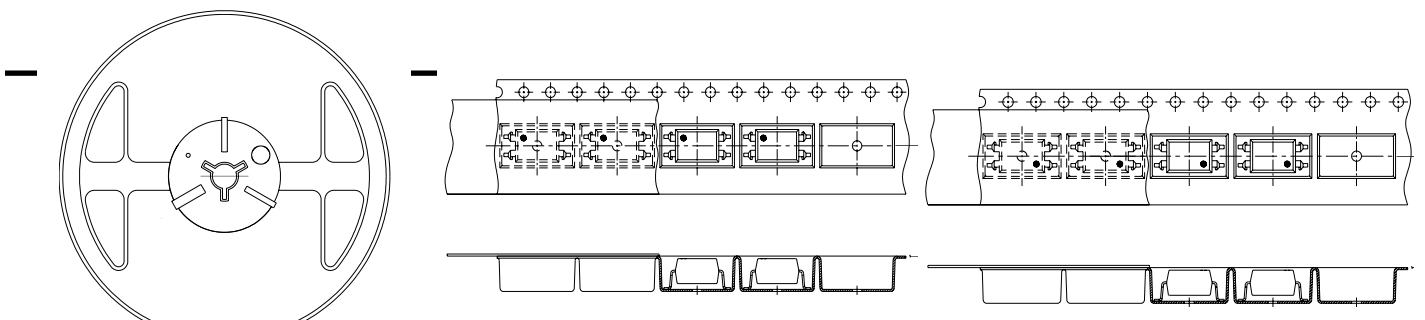

Technical Data Sheet
Photocoupler

Preliminary

EL817L Series

TA

TB

2. Inner Carton

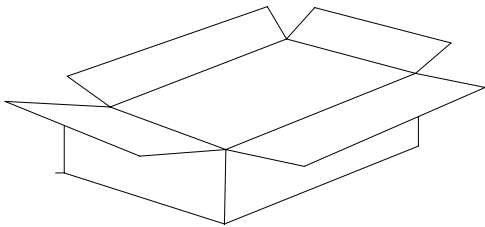

3. Outside Carton

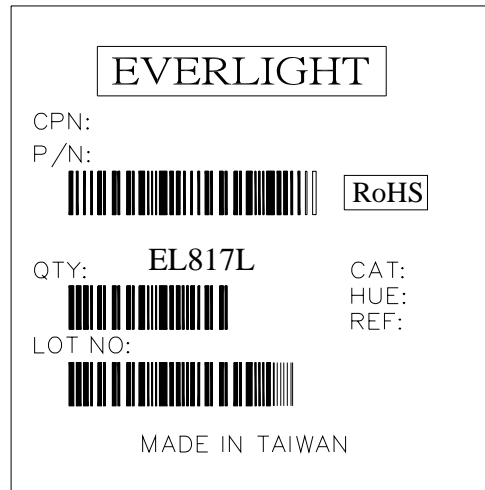
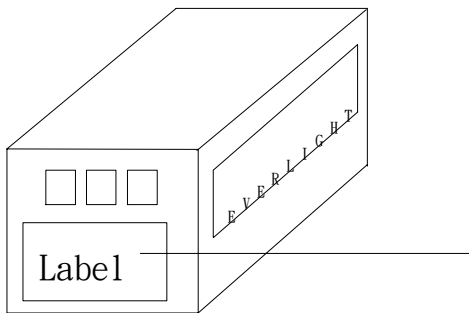

● Packing Quantity

1. 1,000 Pcs / Per Reel
2. 3 Reels / Inner Carton
3. 10 Inner Cartons / Outside Carton