

# High-Performance T-1<sup>3/4</sup> (5 mm) TS AlGaAs Infrared (875 nm) Lamp

## Technical Data

**HSDL-4200 Series**  
**HSDL-4220 30°**  
**HSDL-4230 17°**

### Features

- Very High Power TS AlGaAs Technology
- 875 nm Wavelength
- T-1<sup>3/4</sup> Package
- Low Cost
- Very High Intensity:  
HSDL-4220 - 38 mW/sr  
HSDL-4230 - 75 mW/sr
- Choice of Viewing Angle:  
HSDL-4220 - 30°  
HSDL-4230 - 17°
- Low Forward Voltage for Series Operation
- High Speed: 40 ns Rise Times

- Copper Leadframe for Improved Thermal and Optical Characteristics

### Applications

- IR Audio
- IR Telephones
- High Speed IR Communications  
IR LANs  
IR Modems  
IR Dongles
- Industrial IR Equipment
- IR Portable Instruments

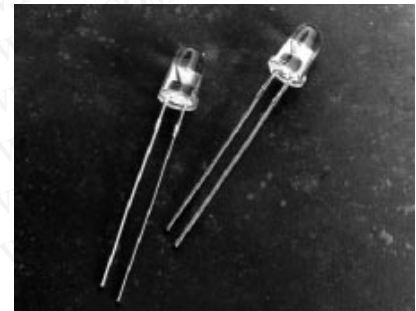

- Interfaces with Crystal Semiconductor CS8130 Infrared Transceiver

### Package Dimensions

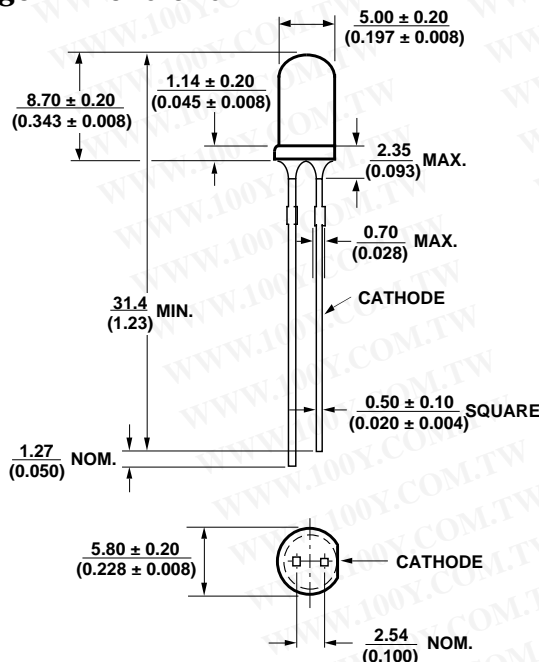

### Description

The HSDL-4200 series of emitters are the first in a sequence of emitters that are aimed at high power, low forward voltage, and high speed. These emitters utilize the Transparent Substrate, double heterojunction, Aluminum Gallium Arsenide (TS AlGaAs) LED technology. These devices are optimized for speed and efficiency at emission wavelengths of 875 nm. This material produces high radiant efficiency over a wide range of currents up to 500 mA peak current. The HSDL-4200 series of emitters are available in a choice of viewing angles, the HSDL-4230 at 17° and the HSDL-4220 at 30°. Both lamps are packaged in clear T-1<sup>3/4</sup> (5 mm) packages.

勝特力材料 886-3-5753170  
 勝特力电子(上海) 86-21-34970699  
 勝特力电子(深圳) 86-755-83298787  
[Http://www.100y.com.tw](http://www.100y.com.tw)

The package design of these emitters is optimized for efficient power dissipation. Copper leadframes are used to obtain better thermal performance than the traditional steel leadframes.

The wide angle emitter, HSDL-4220, is compatible with the IrDA SIR standard and can be used with the HSDL-1000 integrated SIR transceiver.

### Absolute Maximum Ratings

Parameter	Symbol	Min.	Max.	Unit	Reference
Peak Forward Current	$I_{\text{FPK}}$		500	mA	[2], Fig. 2b Duty Factor = 20% Pulse Width = 100 $\mu\text{s}$
Average Forward Current	$I_{\text{FAVG}}$		100	mA	[2]
DC Forward Current	$I_{\text{FDC}}$		100	mA	[1], Fig. 2a
Power Dissipation	$P_{\text{DISS}}$		260	mW	
Reverse Voltage ( $I_{\text{R}} = 100 \mu\text{A}$ )	$V_{\text{R}}$	5		V	
Transient Forward Current (10 $\mu\text{s}$ Pulse)	$I_{\text{FTR}}$		1.0	A	[3]
Operating Temperature	$T_{\text{O}}$	0	70	$^{\circ}\text{C}$	
Storage Temperature	$T_{\text{S}}$	-20	85	$^{\circ}\text{C}$	
LED Junction Temperature	$T_{\text{J}}$		110	$^{\circ}\text{C}$	
Lead Soldering Temperature [1.6 mm (0.063 in.) from body]			260 for 5 seconds	$^{\circ}\text{C}$	

#### Notes:

- Derate linearly as shown in Figure 4.
- Any pulsed operation cannot exceed the Absolute Max Peak Forward Current as specified in Figure 5.
- The transient peak current is the maximum non-recurring peak current the device can withstand without damaging the LED die and the wire bonds.

### Electrical Characteristics at 25 $^{\circ}\text{C}$

Parameter	Symbol	Min.	Typ.	Max.	Unit	Condition	Reference
Forward Voltage	$V_{\text{F}}$	1.30	1.50 2.15	1.70	V	$I_{\text{FDC}} = 50 \text{ mA}$ $I_{\text{FPK}} = 250 \text{ mA}$	Fig. 2a Fig. 2b
Forward Voltage Temperature Coefficient	$\Delta V/\Delta T$		-2.1 -2.1		mV/ $^{\circ}\text{C}$	$I_{\text{FDC}} = 50 \text{ mA}$ $I_{\text{FDC}} = 100 \text{ mA}$	Fig. 2c
Series Resistance	$R_{\text{S}}$		2.8		ohms	$I_{\text{FDC}} = 100 \text{ mA}$	
Diode Capacitance	$C_{\text{O}}$		40		pF	0 V, 1 MHz	
Reverse Voltage	$V_{\text{R}}$	2	20		V	$I_{\text{R}} = 100 \mu\text{A}$	
Thermal Resistance, Junction to Pin	$R\theta_{\text{JP}}$		110		$^{\circ}\text{C}/\text{W}$		

### Optical Characteristics at 25°C

Parameter	Symbol	Min.	Typ.	Max.	Unit	Condition	Reference
Radiant Optical Power HSDL-4220	$P_O$		19 38		mW	$I_{FDC} = 50 \text{ mA}$ $I_{FDC} = 100 \text{ mA}$	
HSDL-4230	$P_O$		16 32		mW	$I_{FDC} = 50 \text{ mA}$ $I_{FDC} = 100 \text{ mA}$	
Radiant On-Axis Intensity HSDL-4220	$I_E$	22	38 76 190	60	mW/sr	$I_{FDC} = 50 \text{ mA}$ $I_{FDC} = 100 \text{ mA}$ $I_{FPK} = 250 \text{ mA}$	Fig. 3a Fig. 3b
HSDL-4230	$I_E$	39	75 150 375	131	mW/sr	$I_{FDC} = 50 \text{ mA}$ $I_{FDC} = 100 \text{ mA}$ $I_{FPK} = 250 \text{ mA}$	Fig. 3a Fig. 3b
Radiant On-Axis Intensity Temperature Coefficient	$\Delta I_E / \Delta T$		-0.35 -0.35		%/°C	$I_{FDC} = 50 \text{ mA}$ $I_{FDC} = 100 \text{ mA}$	
Viewing Angle HSDL-4220	$2\theta_{1/2}$		30		deg	$I_{FDC} = 50 \text{ mA}$	Fig. 6
HSDL-4230	$2\theta_{1/2}$		17		deg	$I_{FDC} = 50 \text{ mA}$	Fig. 7
Peak Wavelength	$\lambda_{PK}$	860	875	895	nm	$I_{FDC} = 50 \text{ mA}$	Fig. 1
Peak Wavelength Temperature Coefficient	$\Delta\lambda / \Delta T$		0.25		nm/°C	$I_{FDC} = 50 \text{ mA}$	
Spectral Width—at FWHM	$\Delta\lambda$		37		nm	$I_{FDC} = 50 \text{ mA}$	Fig. 1
Optical Rise and Fall Times, 10%-90%	$t_r / t_f$		40		ns	$I_{FDC} = 50 \text{ mA}$	
Bandwidth	$f_c$		9		MHz	$I_F = 50 \text{ mA}$ $\pm 10 \text{ mA}$	Fig. 8

### Ordering Information

Part Number	Lead Form	Shipping Option
HSDL-4220	Straight	Bulk
HSDL-4230	Straight	Bulk

勝特力材料 886-3-5753170  
 勝特力电子(上海) 86-21-34970699  
 勝特力电子(深圳) 86-755-83298787  
[Http://www.100y.com.tw](http://www.100y.com.tw)

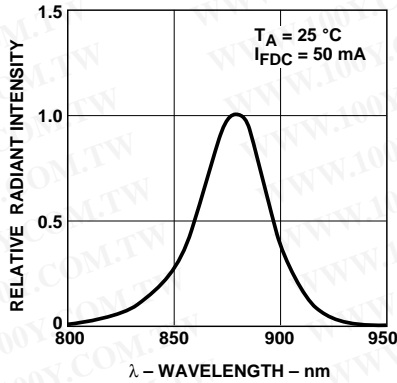

Figure 1. Relative Radiant Intensity vs. Wavelength.

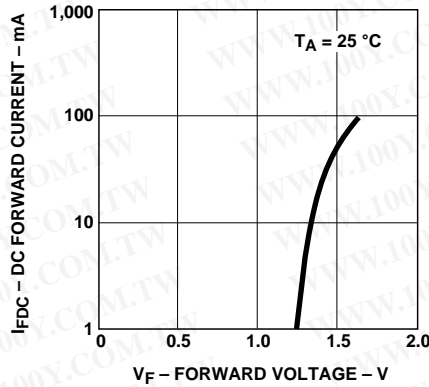

Figure 2a. DC Forward Current vs. Forward Voltage.

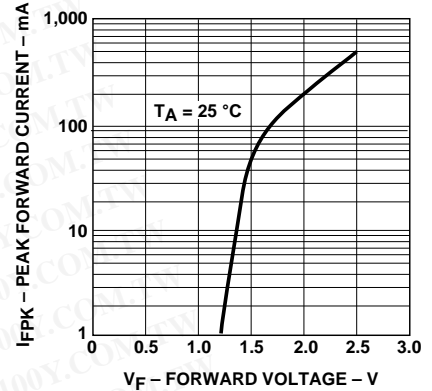

Figure 2b. Peak Forward Current vs. Forward Voltage.

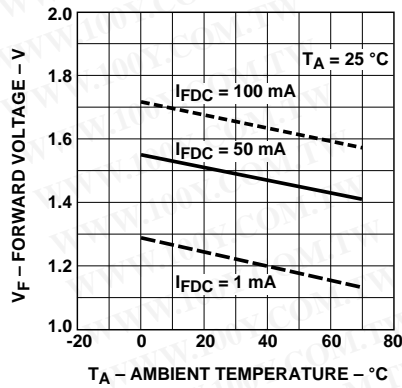

Figure 2c. Forward Voltage vs. Ambient Temperature.

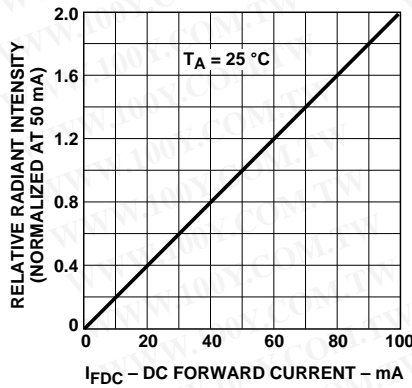

Figure 3a. Relative Radiant Intensity vs. DC Forward Current.

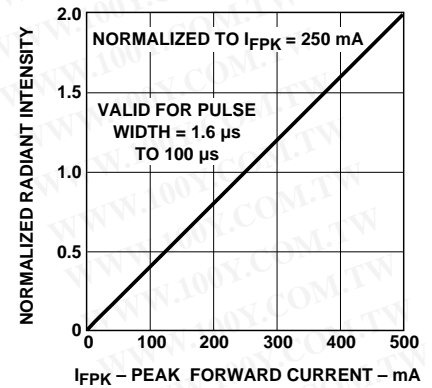

Figure 3b. Normalized Radiant Intensity vs. Peak Forward Current.

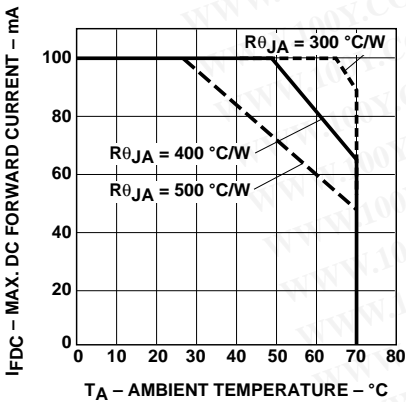

Figure 4. Maximum DC Forward Current vs. Ambient Temperature. Derated Based on  $T_{JMAX} = 110^{\circ}C$ .

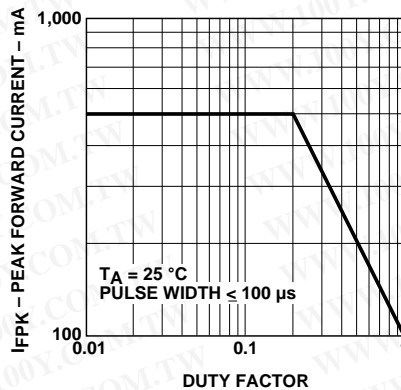

Figure 5. Maximum Peak Forward Current vs. Duty Factor.

勝特力材料 886-3-5753170  
 勝特力电子(上海) 86-21-34970699  
 勝特力电子(深圳) 86-755-83298787  
[Http://www.100y.com.tw](http://www.100y.com.tw)

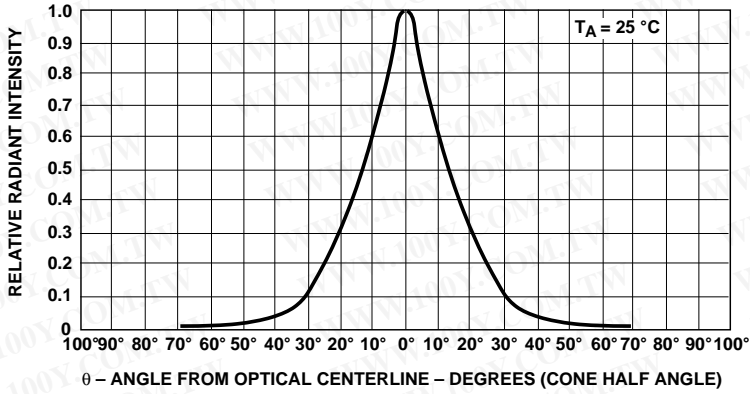

Figure 6. Relative Radiant Intensity vs. Angular Displacement HSDL-4220.

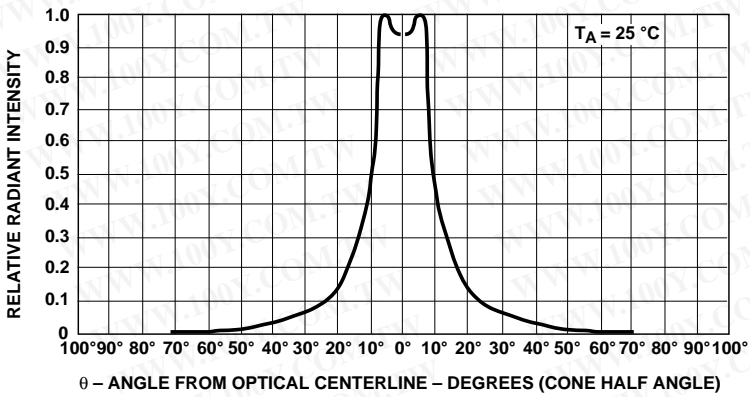

Figure 7. Relative Radiant Intensity vs. Angular Displacement HSDL-4230.

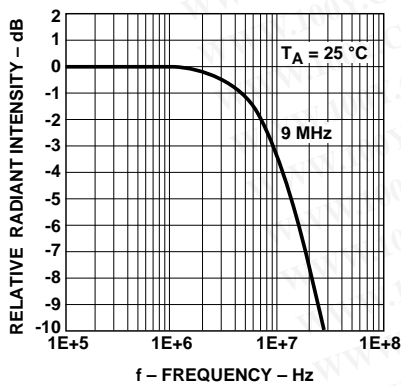

Figure 8. Relative Radiant Intensity vs. Frequency.

勝特力材料 886-3-5753170  
 勝特力电子(上海) 86-21-34970699  
 勝特力电子(深圳) 86-755-83298787  
[Http://www.100y.com.tw](http://www.100y.com.tw)