

◆Shape / 外觀 :

勝特力材料 886-3-5753170
 勝特力电子(上海) 86-21-34970699
 勝特力电子(深圳) 86-755-83298787
[Http://www.100y.com.tw](http://www.100y.com.tw)

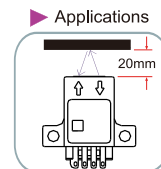
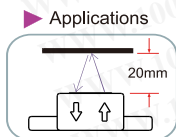

◆Specifications / 規格表 :

Model / 型號	SPR-401-N	SPR-401-P	SPR-402-N	SPR-402-P
Sensing type / 檢出方式	Diffuse Reflection / 擴散反射式			
Sensing distance / 檢出距離	20mm, 黑色泡棉 40x20			
Emitting light / 發光源	Infrared LED 940 nm			
Operating voltage / 工作電壓	DC12 ~ 24 V			
Current Consumption / 消耗電流	25 mA Max.			
Load current / 負載電流	100mA Max. at DC24V			
Output type / 輸出模式	NPN L.on/D.on	PNP L.on	NPN L.on/D.on	PNP L.on
Response time / 反應時間	1 ms Max.			
Insulation resistance / 隔離阻抗	20MΩ min. (DC500V)			
Voltage withstandability / 絕緣耐壓	AC1000V 60Hz for 60 Sec.			
Operating temperature/工作溫度	- 20 °C ~ + 45 °C			
Ambient humidity / 工作溼度	35% ~ 85% RH			
Material / 外觀材質	PC			
Wiring method / 出線方式	EE1001/EE1006			
Weight / 重量	Approx. 3g			

◆Dimensions/尺寸圖 :

SPR-401-N/P

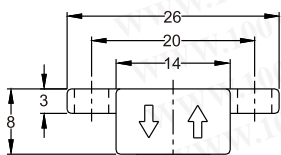

SPR-402-N/P

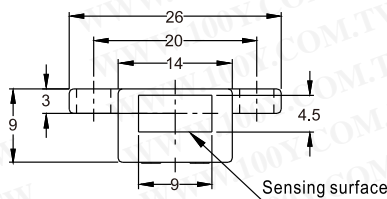

NPN Type

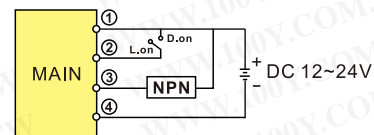
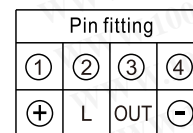

PNP Type

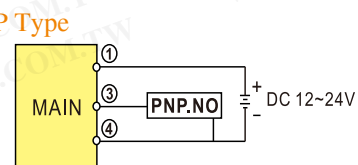
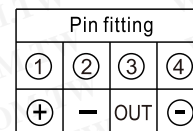

P Type

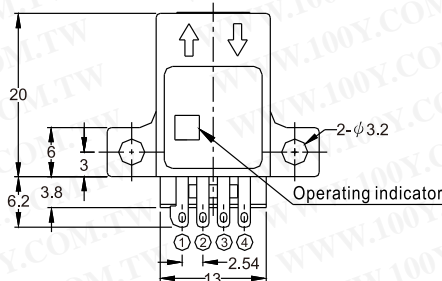
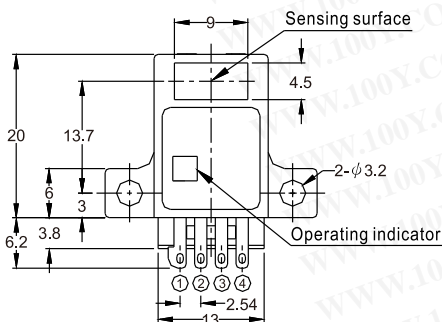
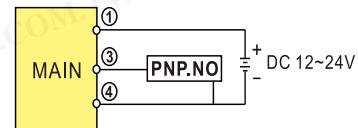

◆ Applications / 應用 :

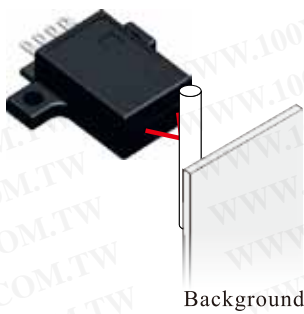

(A) Not affected by the background.

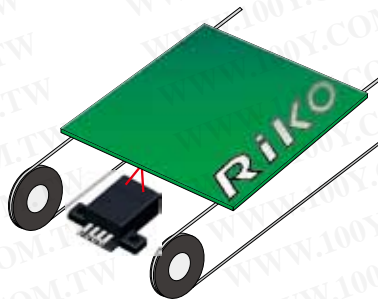

(B) To detect the PCB boards.



(C) To detect the transparent objects.

◆ Wiring diagrams / 線路圖 :

(a) NPN Type

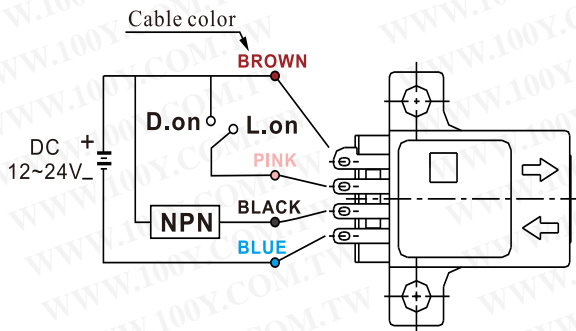

(b) PNP Type

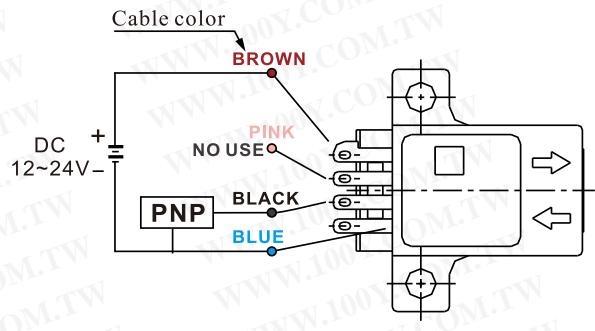

◆ Connectors / 線材 :

Model / 產品圖	Dimensions / 尺寸圖	Cable Color	Available Model	Operation Instructions
<p>EE-1006</p>		1-BROWN 2-PINK 3-BLACK 4-BLUE	SPR Series	
<p>EE-1001</p>		1-BROWN 2-PINK 3-BLACK 4-BLUE	SPR Series	

Fiber

Photo Sensor

Area Sensor

Ultrasonic Sensors

Inductive Proximity Sensor

Capacitive Proximity Sensor

Timer / Counter

Others

Accessories