

High-powered light transmission capable of withstanding adverse environmental conditions. Optional parts available for a wide range of applications

Detecting distance: 50 m max.  
(NT50P)



Model NT50  
Model NT50P

Detecting distance: 100 m max.  
(NT100P)



Model NT100  
Model NT100P

The NT50/100(P) Series sensors are high-powered CMDs designed to withstand severe operating environment (water, dust, etc.).

### Features

- Smallest size of long-distance sensors
- 3-point level indicator with margin for reliable detection  
The green LED is illuminated at a level 8 times as much as the operation level but the inherent performance of the emission is over tenfold.
- DIN compatible robust Zinc die-cast case
- Integrated light emission monitor circuit in transmitter  
Alarm signal is output if light emission stops in the unlikely event of failure.
- Operation mode selectable  
Operation mode is selectable between Light-ON and Dark-ON with the switch provided.

### Panel Description

#### Transmitter

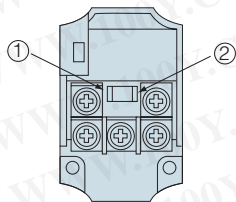

- ① P.L. Indicator
- ② OP.L. Light emission monitoring operation indicator  
Illuminated when transmitter is functioning normally.

#### Receiver

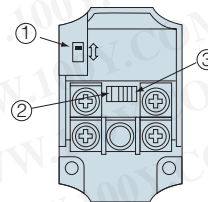

- ① Light-ON/Dark-ON selector switch  
Set according to the situation
- ② Operation indicator  
Illuminated when output is activated.
- ③ Level indicator  
A set of 3 LEDs indicates stability.

勝特力材料 886-3-5753170  
勝特力电子(上海) 86-21-34970699  
勝特力电子(深圳) 86-755-83298787

[Http://www.100y.com.tw](http://www.100y.com.tw)

## Rating/Performance/ Specification/ Environmental Specification

Models	Set type	NT50	NT100	NT50P	NT100P
	Transmitter type	NTL50	NTL100	NTL50P	NTL100P
	Receiver type	NTR50	NTR100	NTR50P	NTR100P
Detection method	Through-beam				
Detecting distance	50m	100m	50m	100m	
Detection object	ø22mm min.	ø28mm min.	ø22mm min.	ø28mm min.	
Power Supply	12-24VDC ±10% Ripple 10% max.		100 to 240V AC ±10% 50/60Hz		
Current consumption / Power consumption	Transmitter: 30mA max. / Receiver: 35mA max.		Transmitter: 5W max. / Receiver: 5W max.		
Output mode	NPN open collector Rating: sink current 200mA (30VDC) max.		Relay contact output 1C Rating: 250V AC 2A max. (resistance load)		
Operation mode	Light-ON/Dark-ON selectable (with switch)				
Light monitor	NPN open collector Rating: sink current 200mA (30VDC) max.		Relay contact output 1C Rating: 250V AC 2A max. (resistance load)		
	Power supply				
Lighting	Normal (ON)				
	Abnormal (OFF)				
Output	ON				
	OFF				
Safety margin output	NPN open collector Rating: sink current 200mA (30VDC) max.				
Response time	5ms max.		20ms max.		
Light source	Infrared LED (910nm)				
Indicator	(Transmitter) P.L: Power indicator (Green LED) ... Illuminated when power-on				
	OP.L: Monitor indicator (Red LED) ... Illuminated when emit light normally				
	(Receiver) OP.L: Operation indicator (Red LED) ... Illuminated when output-on				
	LEVEL: Level indicator (Three level display) LEVEL1: yellow LED illuminated when light intensity of about twice as much as operation level is detected. LEVEL2: yellow LED illuminated when light intensity of about four times as much as operation level is detected. LEVEL3: green LED illuminated when light intensity of about eight times as much as operation level is detected.				
Switch (SW)	Light-ON/Dark-ON selector switch provided		(Remove the case lid of the receiver to access the switch.) Light-ON ... Output at light receiving Dark-ON ... Output at light blocking		
Case materials	Zinc die-cast				
Connection	Terminal block (screw: M3.5, width: 8.1mm)				
Mass	Transmitter: about 700g	Transmitter: about 800g	Transmitter: about 700g	Transmitter: about 800g	
	Receiver: about 700g	Receiver: about 800g	Receiver: about 700g	Receiver: about 800g	

## Environmental Specification

Environment	Ambient light (on light receiving surface)	50,000 lx max. (incandescent lamp)	50,000 lx max. (incandescent lamp) 100,000 lx max. (sunlight)
	Ambient temperature	-25 - +55°C (Non-freezing)*	
	Storage temperature	-40 - +70°C (Non-condensing)	
	Ambient humidity	35 - 85%RH (Non-condensing)	
	Protective structure	IP66	
	Vibration	10-55 Hz / 1.5 mm amplitude / 2 hours each in 3 direction	
	Shock	1000 m/s <sup>2</sup> / 3 times each in 3 directions	500 m/s <sup>2</sup> / 3 times each in 3 directions
	Dielectric withstanding	500 VAC for 1 minute (between input/output and case)	2000 VAC for 1 minute (between input/output and case)
	Insulation resistance	500 VDC, 20 MΩ or higher	

\* Some models may be used in environment of up to 110°C by attaching water-cooling jacket.

Contact Takex for details.

# NT

## Input/Output Circuit and Connection

NT50/NT100

(Transmitter)

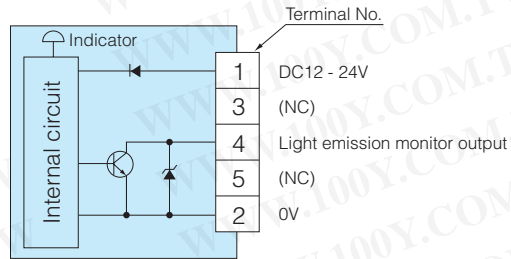

(Receiver)

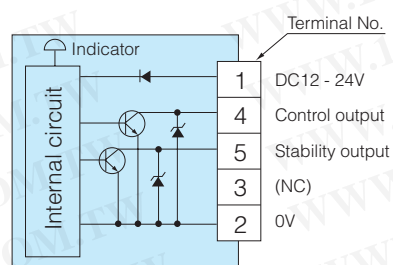

NT50P/NT100P

(Transmitter)

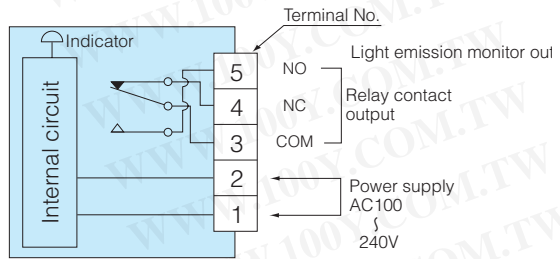

(Receiver)

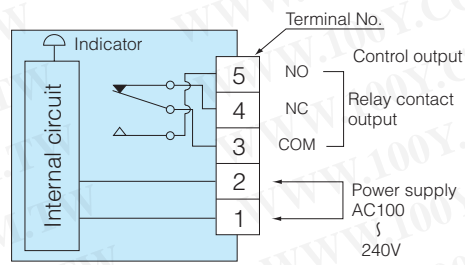

### • Connection

For connection, use cables of 9-11 mm in diameter.

Loosen the screws on the lid of the body to remove the lid.

The rubber packing must be attached in the right orientation.

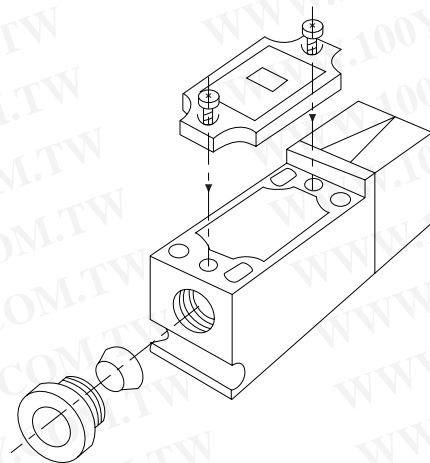

## Directional Characteristics (Typical example)

NT50 (P)

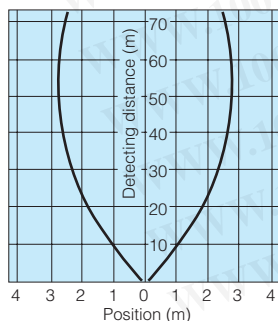

NT100 (P)

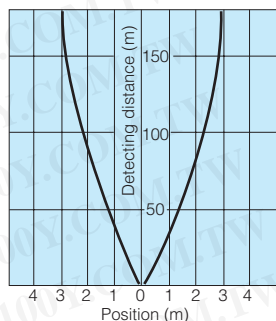

## Distance-Output Characteristics (Typical example)

NT50 (P)

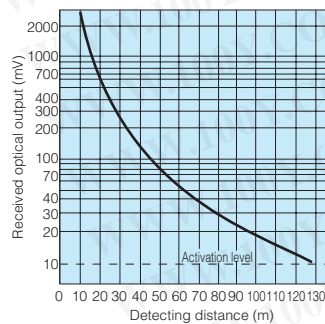

NT100 (P)

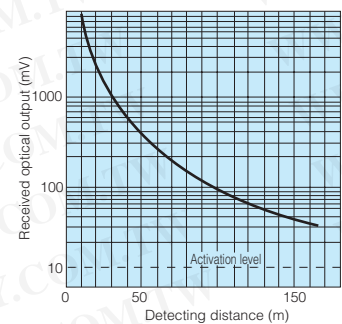

## Optional Parts

**Checker CR2** Used for aligning the light axis while observing the light emitted from the transmitter with "sound" and "level indicator." Find the light from the transmitter with the checker and adjust the orientation of the transmitter so that the receiver is installed at the center of the light.

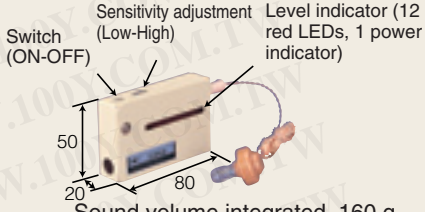
Sound volume integrated, 160 g  
Level indicator provided

**Hood** (Applicable to NT50(P))

**Hood H301**



Energy-saving airless dust hood taking advantage of muffler effect for preventing soiling of lens.

**Airless hood F301**



Energy-saving airless dust hood taking advantage of muffler effect for preventing soiling of lens.

**Air purge hood A301**



Air purge hood for prevention of soiling of lens.

**Airless hood F38S** (Applicable to NT100(P))



Energy-saving airless dust hood taking advantage of muffler effect for preventing soiling of lens.

**Pinhole plate** (Applicable to NT50(P))

Use of pinhole plates reduces the smallest allowable detection object diameter and activation area. Note that the detecting distance is reduced as well.



Model	Pinhole diameter
30P1	ø1
30P3	ø3
30P5	ø5
30P7	ø7
30P10	ø10

(mm)

• **Directional Characteristics (Typical example)**

NT50(P): with pinhole plate (optional) attached to both transmitter and receiver

With 30P1/30P3 attached

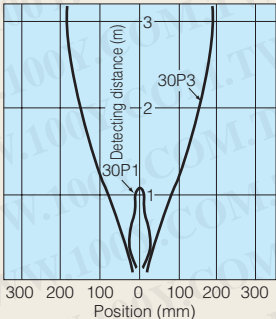

With 30P5/30P7/30P10 attached

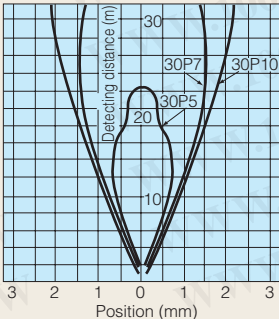

• **Distance-Output Characteristics (Typical example)**

NT50(P): with pinhole plate (optional) attached to both transmitter and receiver

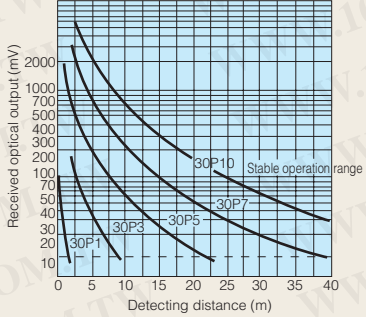

• **Installation**

For mounting, use a solid base not subject to vibration.

Use 2 M6 bolts for securing the sensor body (separately prepare bolts, nuts, washers, etc.).

# NT

## Dimensions (in mm)

Model NT50

NT50P

CAD

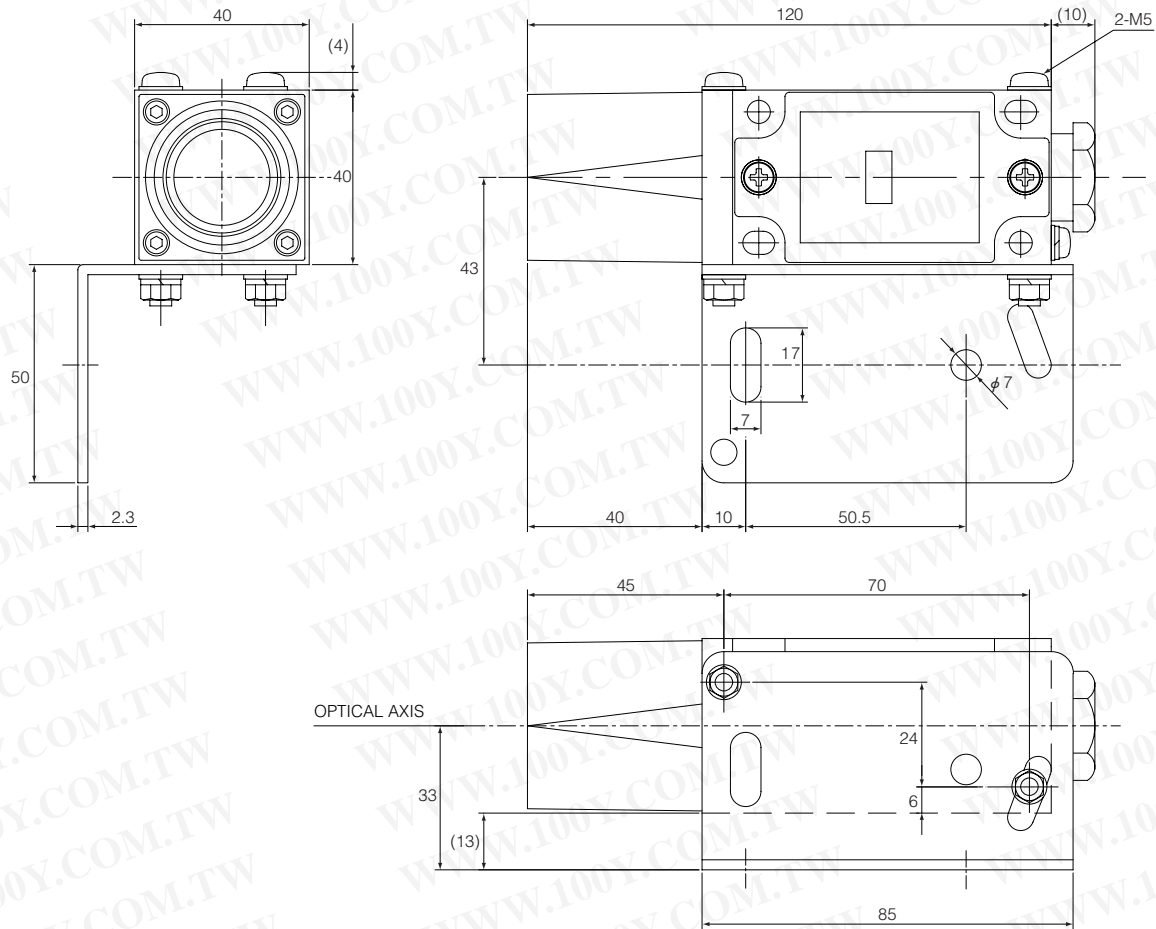

### Hoods (optional)

H301 (hood)

CAD

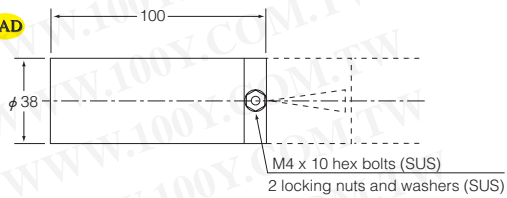

A301 (air purge hood)

CAD

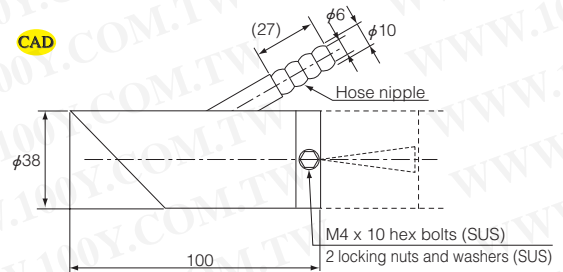

F301 (Airless hood)

CAD

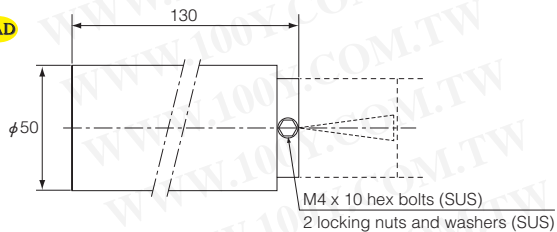

Air purge specification  
 Flow rate...200 l/min  
 Withstand pressure...0.98MPa

勝特力材料 886-3-5753170  
 勝特力电子(上海) 86-21-34970699  
 勝特力电子(深圳) 86-755-83298787  
[Http://www.100y.com.tw](http://www.100y.com.tw)

NT

Dimensions (in mm)

Model NT100

NT100P

CAD

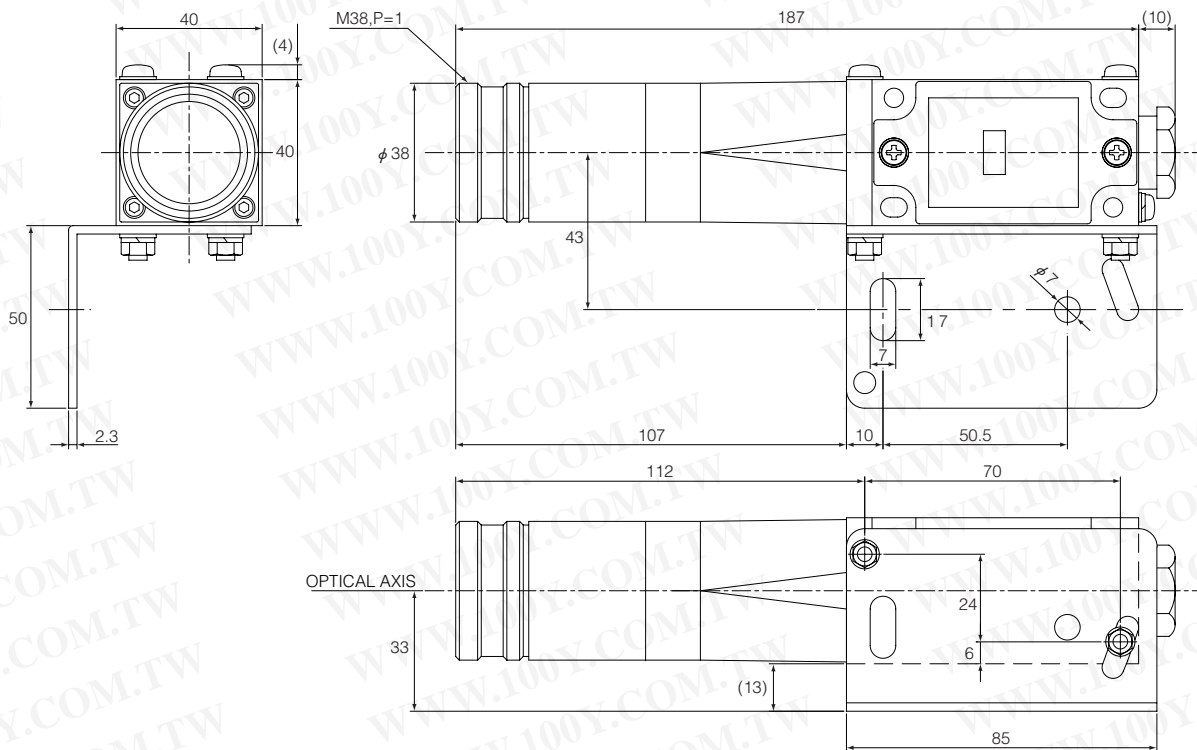

With F38S Airless hood (optional) attached

CAD

