



勝特力電材超市-龍山店 886-3-5773766  
勝特力電材超市-光復店 886-3-5729570  
勝特力電子(上海) 86-21-34970699  
勝特力電子(深圳) 86-755-83298787  
<http://www.100y.com.tw>

# New Flagship Bench-top DC Power Supply

**NEW**  
2000 W model

## Compact Wide Range DC Power Supply **PWR-01 Series**

A wide range of voltage and current settings can be combined within its output power rating (3 to 4 times)

LAN (LXI compliant) /USB/RS232C as standard interface

Sequence creation software : Way for PWR-01

All models are equipped with front output terminals as standard

Variable internal resistance function

# The Bench-top

## New flagship bench-top DC power supply

*L, ML, MH, and H voltage types. Lineup of 16 models in total!*

The PWR-01 is a series of high performance, multifunctional, compact, wide-range DC power supplies. It consists of 16 models in total with 4 maximum voltage outputs (L, ML, MH, and H) and 4 maximum power outputs (400 W, 800 W, 1200 W and 2000 W). The series is equipped with LAN (LXI), USB, and RS232C as standard interfaces that are essential for system integration. The PWR-01 also features front-facing output terminals, variable internal resistance, bleeder ON/OFF functions, CC/CV priority switching function, synchronized operation, various protections, and programmable internal memory.



**Actual size**

### Lineup

#### 40 V type

Type	Model	Voltage output	Current output	Power output
L	PWR401L	0 V to 40 V	0 A to 40 A	400 W
	PWR801L		0 A to 80 A	800 W
	PWR1201L		0 A to 120 A	1200 W
	PWR2001L		0 A to 200 A	2000 W

#### 80 V type

Type	Model	Voltage output	Current output	Power output
ML	PWR401ML	0 V to 80 V	0 A to 20 A	400 W
	PWR801ML		0 A to 40 A	800 W
	PWR1201ML		0 A to 60 A	1200 W
	<b>NEW</b> PWR2001ML		0 A to 100 A	2000 W

#### 240 V type

Type	Model	Voltage output	Current output	Power output
MH	PWR401MH	0 V to 240 V	0 A to 5 A	400 W
	PWR801MH		0 A to 10 A	800 W
	PWR1201MH		0 A to 15 A	1200 W
	<b>NEW</b> PWR2001MH		0 A to 25.0 A	2000 W

#### 650 V type

Type	Model	Voltage output	Current output	Power output
H	PWR401H	0 V to 650 V	0 A to 1.85 A	400 W
	PWR801H		0 A to 3.70 A	800 W
	PWR1201H		0 A to 5.55 A	1200 W
	<b>NEW</b> PWR2001H		0 A to 9.25 A	2000 W

Universal Communication Interface Combined with Wide Range Output Coverage!

## Sequence Function

Synchronized operation using trigger signals

## Communication Interface

LAN (LXI compliant) /USB/RS232C as standard interface

## Front Output Terminals

Equipped with front output terminal as standard \*Up to 10 A

## Wide Range

3 to 4 times coverage ratio for voltage and current range

## Variable Internal Resistance Function

Easy simulation of power supplies carrying internal resistance made possible

## Durable Performance

Operating temperature guaranteed up to 50 °C.

\*Storage temperature is -25 °C to +60 °C (-13 °F to 140 °F).



at 50°C  
(122°F)  
capable of operating  
at full load  
continuously

Convenient sequence  
generation for the  
PWR-01

Sequence Creation  
Software

SD027-PWR-01  
(Wavy for PWR-01)



For details,  
please refer to page 14 .



Compact Wide Range DC Power Supply

# PWR-01 Series



## ■ Safe and easy to use front-facing output terminals

All models are equipped with front-facing output terminals (up to 10 A) optimized for bench-top use. Please connect to the output terminals with a safety plug. \*This product's specifications were recorded using the back-side output terminals.



### ● Safety plugs (Options)



**TL41** (screw connection type)  
Red and black, one set each  
1000 V/ CATII max 32 A



**TL42** (solder connection type)  
Red and black, one set each  
1000 V/ CATII max 32 A

## ■ Sequence function

The sequence function allows you to automatically execute programs that you have set in advance, one operation at a time. However, you cannot create sequences using only the panel. Sequence programs are created using commands from a PC. Once a sequence is executed via remote control, the program is saved onto the PWR-01's internal memory and then can be executed directly from the front panel without a PC.

## ■ Synchronized operation

Synchronized operation allows for settings and sequence programs to be synchronized via trigger signals. Different PWR-01 models (e.g., 400 W model and 800 W model) can be easily mixed and matched with no difficulties. Synchronized operation is also possible in parallel operation. In order to successfully synchronize your power supplies, please configure various settings using remote control commands. After completing configuration, synchronized operation can be performed without a PC.

## ■ Standard communication interface

The series has been equipped with LAN (LXI), USB, and RS232C as standard interfaces, essential for system integration. When using RS232C, please order the D-sub 9P-RJ45 transformation cable (RD-8P/9P) option, sold separately. The PWR-01 has also been equipped with J1/J2 connectors for analog control.

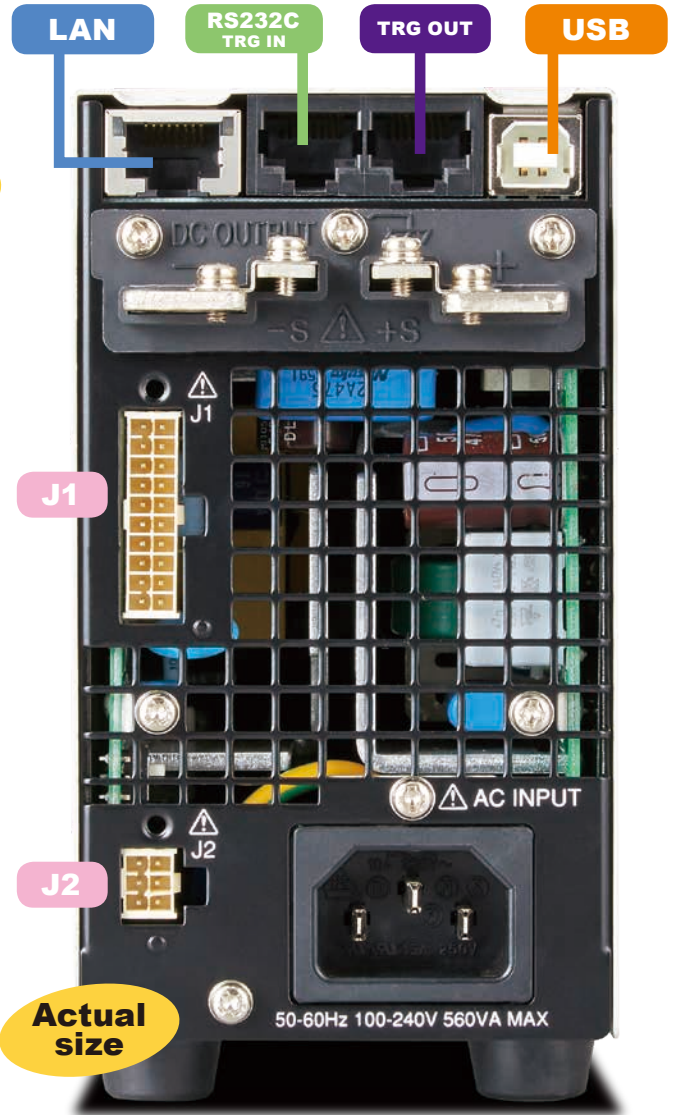

Rear Panel : 400 W model

## Sequence Function/Synchronized Operation Concept Map

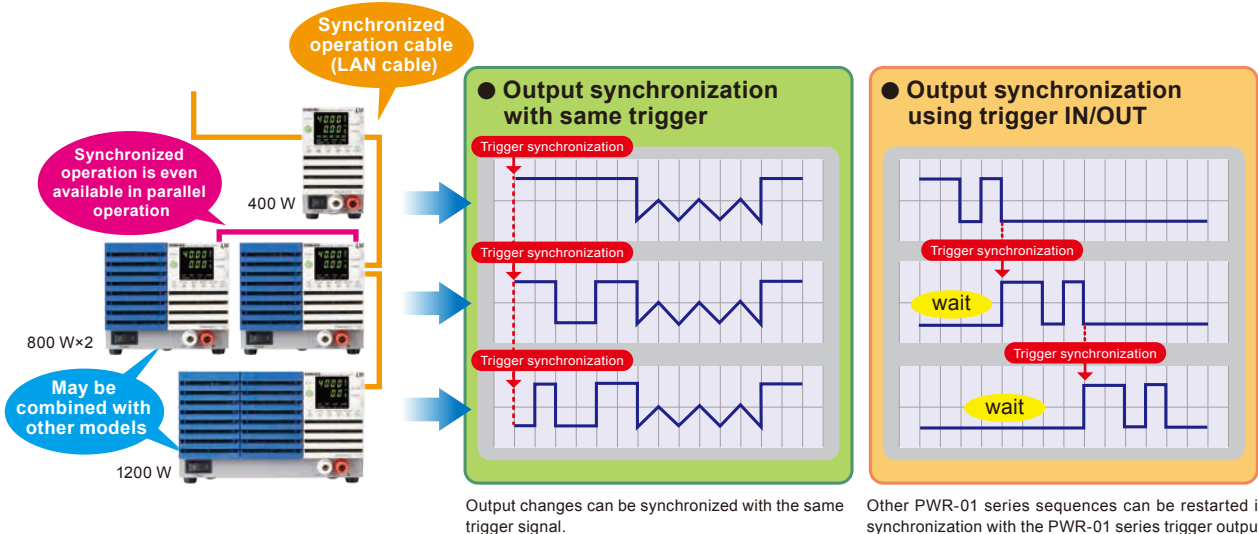

## ■ Bleeder ON/OFF function

The PWR-01's capacitor is connected to its output terminals, equipped with a bleeder circuit that discharges electricity when the OUTPUT is set to OFF. For example, when a battery is connected to the output terminal, or when the bleeder circuit is set to ON, the bleeder circuit will discharge electricity from the battery even when the OUTPUT is OFF. In cases like these, excessive electric discharge can be prevented by setting the bleeder circuit to OFF. This makes it possible to prevent current backflow from a battery without using a diode.

Bleeder circuit	Description
Off *1	Bleeder circuit off
Normal bleeder	Bleeder circuit on
Hyper bleeder *2	When a normal bleeder is used, falling time with no load can be shortened to approximately 70% and eliminate test cycle time. This is effective for situations in which one wants to operate ON/OFF with capacitive load as quickly as possible.

\*1. Even if the output terminals are open and the output is turned off or the voltage setting is at 0 V, up to several hundred millivolts of voltage may appear across the output terminals.

\*2. The fan speed is fixed to the maximum speed.

## ■ Customizable startup when turning on output

You can choose the priority operation mode (CC priority/CV priority) when the output is turned ON.

This can prevent overshoot when turning on the output.

## ■ Output ON/OFF delay function

You can set the delay (DELAY TIME) from when the OUTPUT key is turned on or off to when the output actually turns on or off.

This is useful for tests where precise timing/order of rise and drop voltage is essential according to the load characteristics.

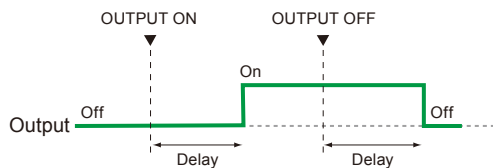

## ■ Soft start/stop function

You can set the rise time and fall time of output current. This is useful when the load cannot follow the sudden rise or fall in the output current or when you want to avoid the overcurrent protection from being activated.

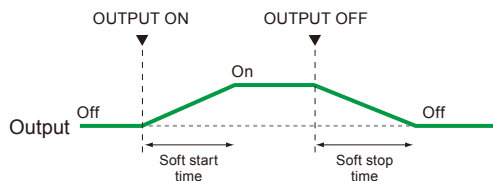

## ■ Master-slave parallel operation

One-control parallel operation is performed by designating one "master" device and connecting it to one or more of the same models being the "slave" devices. The entire system can then be controlled by operating the master machine. Output current can be greatly amplified (maximum output current: single rated output current x number of parallel units) with one-control parallel operation. The maximum number of parallel units including the master device is 3 units for the 400 W and 800 W models and 2 units for the 1200 W and 2000 W models. Differences in output voltage and output current between the master and slave devices are within approximately 5% of their respective rated output.

## ■ Series operation

Up to two units can be connected in series (excluding the H type). The total combined output voltage of the two units is applied to the load. The voltage setting accuracy is the same as the accuracy of an individual unit. \*You cannot perform master-slave configuration in series operation.

## ■ Preset memory function

The preset memory function of the PWR-01 allows you to save up to three combinations of each of the voltage, current, OVP, OCP and UVL values. The saved preset values can be recalled from the preset memory found on the front panel.

## ■ CONFIG setting shortcut function

You can register CONFIG setting parameters to the front panel's SC keys. You can perform tests efficiently by registering CONFIG parameters that you use frequently without consulting the CONFIG menu. Up to three parameters can be registered.

## ■ Multi-channel (VMCB) \* \*virtual multi-channel bus (VMCB)

When multi-channel (VMCB) is used, one personal computer can be connected to multiple PWR-01 series machines (up to 31 units) to construct a virtual multi-channel power source system. This is effective for matching the control timing of multiple PWR-01 series units and for saving communication ports.

### ● Basic configuration with LAN interface and VMCB (example)

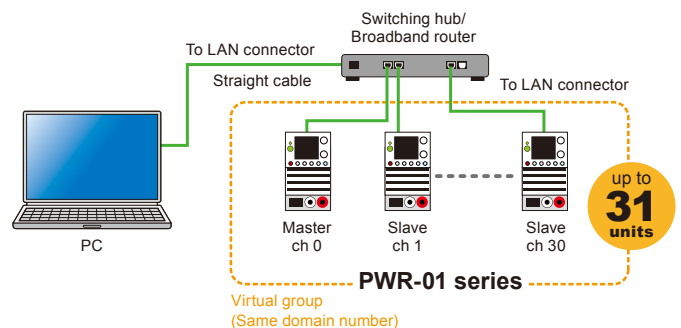

## ■ Easy access with a built-in web server

Use a browser from a PC, smartphone, or tablet to access the web server built into the PWR-01 series for convenient control and monitoring.

\* Connecting with a smartphone, tablet, etc. requires a Wi-Fi environment (wireless LAN router etc.).



\*Screen sample

## External analog control function

The PWR-01 series is equipped with external voltage/resistance control, which is necessary for external analog control and monitoring applications for power supply testing. The input external signal and the output status signal can be accessed through the J1/J2 connectors on the rear panel. When using the J1/J2, please purchase the J1/J2 connector plug kit (OP01-PWR-01) option, sold separately.

### Controlling the output voltage & output current.

#### Control using an external voltage.

It is possible to control the output voltage/output current of the PWR-01 series by using an external voltage.

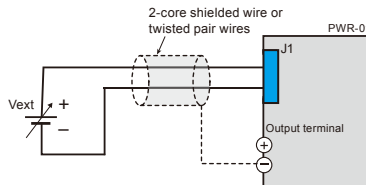

#### Control using an external resistance.

It is possible to control the output voltage/output current of the PWR-01 series by using an external variable resistor.

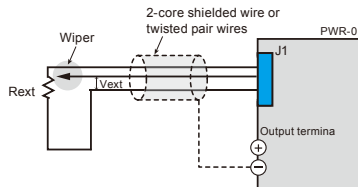

#### Turning output on and off using an external contact.

It is possible to turn the output ON/OFF of the PWR-01 series by using an external contact.

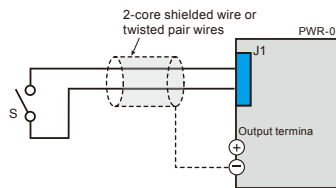

#### Output shutdown control using an external contact.

It is possible to turn the output OFF of the PWR-01 series by using an external contact.

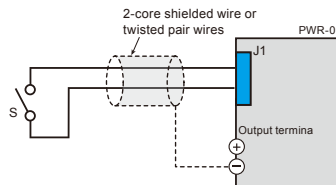

#### Clearing alarms using an external contact.

It is possible to clear the alarm of the PWR-01 series by using an external contact.

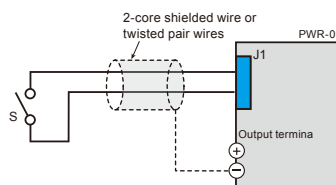

#### Monitoring operation modes.

External monitoring of the output voltage and output current.

### J1 connector pin arrangement

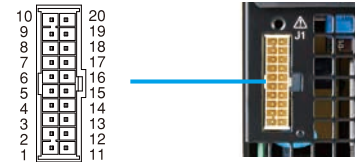

Pin No.	Signal name	Description
J1-1	VPGM	Terminal used to control the output voltage with an external voltage or external resistance. 0 V to 5 V; 0 % to 100 % of the rated output voltage (CF12: LO). 0 V to 10 V; 0 % to 100 % of the rated output voltage (CF12: HI).
J1-2	VMON	Output voltage monitor. 0 % to 100 % of the rated output voltage is generated as a voltage between 0 V and 5 V (CF13: LO) or a voltage between 0 V and 10 V (CF13: HI).
J1-3	REF OUT	Reference voltage for external resistance control. 5.25 V (CF12: LO) / 10.5 V (CF12: HI), maximum output current: 2.5 mA.
J1-4	PRL ON	On when parallel operation is in use and when output is on (output through an open-collector photo-coupler)
J1-5	A GND	External signal common for pins 1 to 3, 6 to 9, 11, 12, 14, 16, and 20. When remote sensing is not used, this is at the same electric potential as the negative output terminal. When remote sensing is used, this is at the same electric potential as the negative electrode (-S) of sensing input.
J1-6	ALM CLEAR	Alarm clear terminal. Alarms are cleared when a low level signal (0 V to 0.5 V) is received or shorted.
J1-7	I SUM	Current output terminal for parallel operation.
J1-8	PRL OUT	Positive output terminal for parallel operation.
J1-9	PRL COMP IN	Correction signal input terminal for parallel operation.
J1-10	A GND	External signal common for pins 1 to 3, 6 to 9, 11, 12, 14, 16, and 20. When remote sensing is not used, this is at the same electric potential as the negative output terminal. When remote sensing is used, this is at the same electric potential as the negative electrode (-S) of sensing input.
J1-11	IPGM	Terminal used to control the output current with an external voltage or external resistance. 0 V to 5 V; 0 % to 100 % of the rated output current (CF12: LO). 0 V to 10 V; 0 % to 100 % of the rated output current (CF12: HI).
J1-12	IMON	Output current monitor. 0 % to 100 % of the rated output current is generated as a voltage between 0 V and 5 V (CF13: LO) or a voltage between 0 V and 10 V (CF13: HI).
J1-13	PRL COM	Common for pin 4.
J1-14	PRL ALM	On when a protection function is activated during parallel operation or when an output shutdown signal is being received.
J1-15	A GND	External signal common for pins 1 to 3, 6 to 9, 11, 12, 14, 16, and 20. When remote sensing is not used, this is at the same electric potential as the negative output terminal. When remote sensing is used, this is at the same electric potential as the negative electrode (-S) of sensing input.
J1-16	SHUT DOWN	Output shutdown control terminal. The output is turned off when set to LOW (0 V to 0.5 V) or shorted.
J1-17	OUTPUT CONT	Output on/off terminal. On when set to LOW (0 V to 0.5 V) or shorted; off when set to HIGH (4.5 V or 5 V) or open (CF15: LO). On when set to HIGH (4.5 V to 5 V) or open; off when set to LOW (0 V or 0.5 V) or shorted (CF15: HI)
J1-18	PRL COMP OUT	Correction signal output terminal for parallel operation.
J1-19	PRL IN-	Negative input terminal for parallel operation.
J1-20	PRL IN+	Positive input terminal for parallel operation.

### J2 connector pin arrangement



Pin No.	Signal name	Description
J2-1	STATUS COM	Common for pins 2 to 6. *1
J2-2	OUT ON STATUS	Outputs a signal when output is on (output through an open-collector photocoupler). *2
J2-3	PWR ON STATUS	Outputs a low level signal when the power is on (output through an open-collector photocoupler). *2
J2-4	ALM STATUS	Outputs a signal when a protection function (OVP, OCP, FOCP, OHP, SENSE, AC-FAIL) is activated or when an output shutdown signal is being received (output through an open-collector photocoupler). *2
J2-5	CV STATUS	Outputs a signal during CV mode (output through an open-collector photocoupler) *2
J2-6	CC STATUS	Outputs a signal during CC mode (output through an open-collector photocoupler). *2

\*1. The status common is floating (isolation voltage of 800 V or less). It is isolated from the control circuit.  
\*2. Open collector output. Maximum voltage: 30 V. Maximum current: 8 mA.

#### J1 and J2 connectors

	J1 connector	J2 connector
Connector type	WF2549-2WR10S3T01 (WCON)	WF2549-2WR03S3T01(WCON)
Housing type	WF2549-2H10W01 (WCON)	WF2549-2H03W01 (WCON)
Terminal (pin)	WF2549-TPS302 (WCON)	WF2549-TPS302 (WCON)
Wire diameter (core wire)	AWG20 to AWG24	AWG20 to AWG24
Manual pressure welding tool	SN-28B (IWISS) or an equivalent product	SN-28B (IWISS) or an equivalent product

CONFIG setting is easy for ON/OFF settings with external contact points that can be easily accessed from the front panel.



## Variable internal resistance function

The variable internal resistance function enables you to easily simulate the internal resistance of rechargeable batteries, solar batteries, fuel cells, and the like.

By setting the internal resistance value in constant voltage (CV) mode, you can decrease the output voltage according to the output current. You can use a CONFIG setting to set the internal resistance.

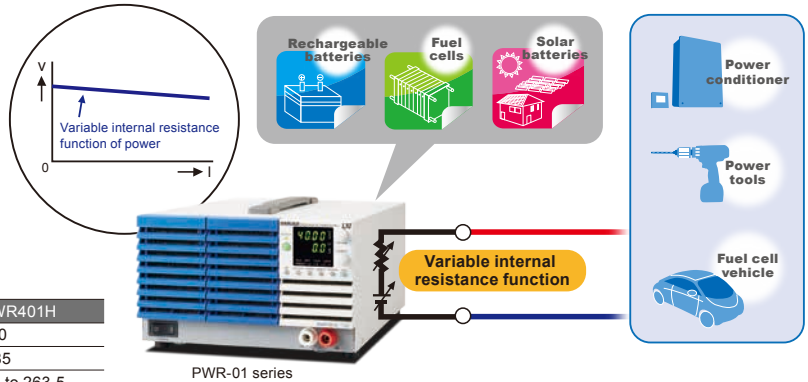

	PWR401L	PWR401ML	PWR401MH	PWR401H
Vrtg [V]	40	80	240	650
Irtg [A]	40	20	5	1.85
Rint [Ω]	0.001 to 1.000	0.001 to 4.000	0.01 to 36.00	0.1 to 263.5
Resolution *1	0.001	0.001	0.01	0.1
	PWR801L	PWR801ML	PWR801MH	PWR801H
Vrtg [V]	40	80	240	650
Irtg [A]	80	40	10	3.7
Rint [Ω]	0.001 to 0.500	0.001 to 2.000	0.01 to 18.00	0.1 to 131.8
Resolution *1	0.001	0.001	0.01	0.1
	PWR1201L	PWR1201ML	PWR1201MH	PWR1201H
Vrtg [V]	40	80	240	650
Irtg [A]	120	60	15	5.55
Rint [Ω]	0.001 to 0.333	0.001 to 1.333	0.01 to 12.00	0.1 to 87.84
Resolution *1	0.001	0.001	0.01	0.01
	PWR2001L	PWR2001ML	PWR2001MH	PWR2001H
Vrtg [V]	40	80	240	650
Irtg [A]	200	100	25	9.25
Rint [Ω]	0.001 to 0.200	0.001 to 0.800	0.01 to 7.20	0.01 to 52.70
Resolution *1	0.001	0.001	0.01	0.01

### Setting range

Vrtg	rated output voltage
Irtg	rated output current
Rint	internal resistance

$$0 < Rint(\min) \leq Rint(\max)$$

$$L \text{ type, ML type: } Rint(\max) = Vrtg / Irtg$$

$$MH \text{ type, H type: } Rint(\max) = Vrtg / Irtg \times 3/4$$

The variable internal resistance function can be configured only in constant voltage(CV) mode.

\*1. Resolution when FINE is in use

The maximum internal resistance that can be set during parallel operation is the value obtained by dividing Rint (max) during standalone operation by the number of units in parallel operation. The resolution is the value obtained by dividing the resolution during standalone operation by the number of units in parallel operation.

## 3 to 4 times ratio power operation

3 to 4 times ratio power operating range covers a wide variety of voltage and current setting combinations.

For example, the 1200 W rated power output PWR1201ML is capable of seamless operation from 80 V/15 A to 20 V/60 A.

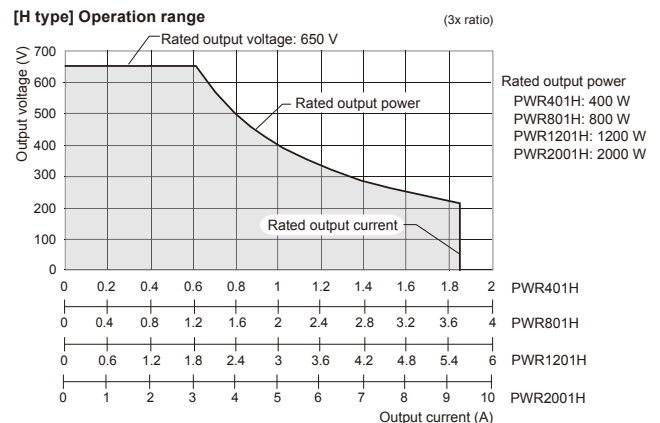
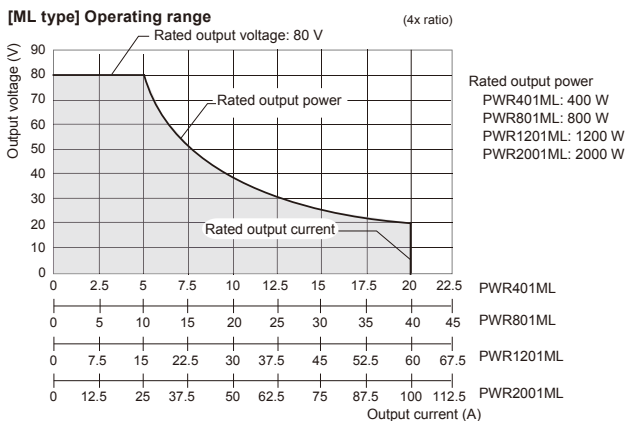
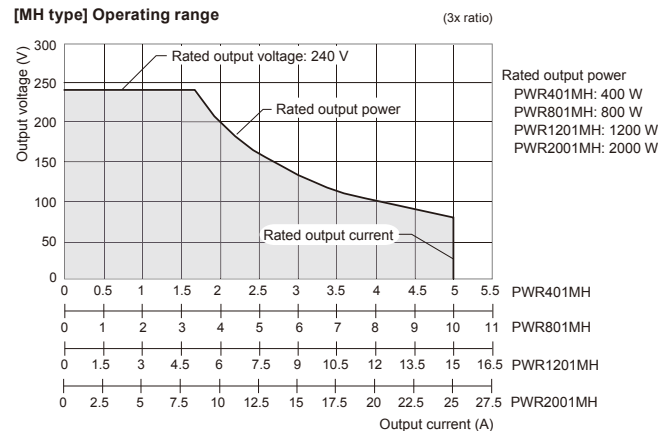
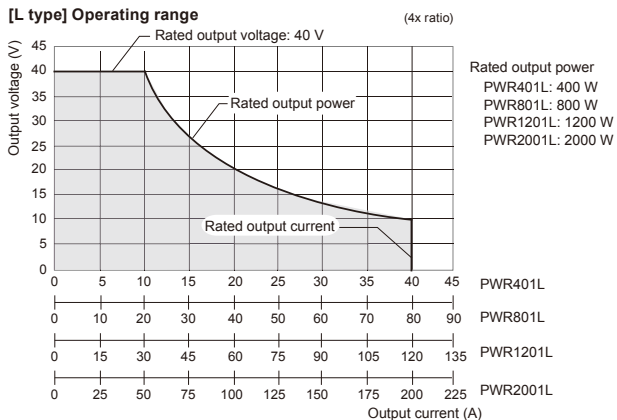



# Specifications

Unless specified otherwise, the specifications are for the following settings and conditions.

●Loads are pure resistive loads. ●The product is warmed up for at least 30 minutes (with current flowing). ●After warm-up, the product must be calibrated correctly in a 23 °C ± 5 °C environment according to the appropriate calibration procedure. ●Values indicated by "TYP" are typical values. They are not guaranteed performance values. ●Values indicated by "rating" are ratings. ●Values indicated by "reading" are readings. ●Values indicated by "f.s." are full scale values. ●The PWR-01 operates over a wide range of output voltage and output current within rated output power. However, the current that can be output with rated output voltage and the voltage that can be output with rated output current are limited by the rated output power. ●The current that can be output with rated output voltage and the voltage that can be output with rated output current are as follows. Maximum output current with rated output voltage = Rated output power / rated output voltage. Maximum output voltage with rated output current = Rated output power / rated output current. ●Rated load and no load are defined as follows: In constant-voltage mode (when the output current is set to a value greater than or equal to the maximum output current with rated output voltage) Rated load: Refers to a resistive load that, when the rated output voltage is applied, makes the flowing current 95 % to 100 % of the maximum output current with rated output voltage. No load: Refers to a load through which no output current flows. In other words, refers to an open load (no load being connected). In constant-current mode (when the output voltage is set to a value greater than or equal to the maximum output voltage with rated output current) Rated load: Refers to a resistive load that, when the rated output current flows, makes the voltage drop to 95 % to 100 % of the maximum output voltage with rated output current. Including the voltage drop in the load cables, the PWR-01 output voltage must not exceed the maximum output voltage with rated output current. No load: Refers to a resistive load that, when the rated output current flows, makes the voltage drop to 10 % of the maximum output voltage with rated output current or 1 V whichever is higher. ●The specifications of the PWR-01 apply to the rear-panel output terminals.

## ● 400 W model

Item/Model	PWR401L	PWR401ML	PWR401MH	PWR401H
<b>AC input</b>				
Nominal input rating	100 Vac to 240 Vac, 50 Hz to 60 Hz, single phase			
Input voltage range	85 Vac to 265 Vac			
Input frequency range	47 Hz to 63 Hz			
Current (TYP) *1	100 Vac	5.6 A		
	200 Vac	2.8 A		
Inrush current (MAX) *2	25 A peak or less			
Power (MAX) *3	560 VA			
Power factor (TYP) *1	0.99 (input voltage: 100 V), 0.97 (input voltage: 200 V)			
Efficiency (MIN) *1	75 % (TYP)			
Hold-up time for power interruption (MIN) *3	20 ms or more			

\*1. At the rated output power for the rated output current.

\*2. Excludes the charge current component that flows through the capacitor of the internal EMC filter circuit immediately after the POWER switch is turned on (for approximately 1 ms).

\*3. 100 Vac, at the rated output power.

Item/Model	PWR401L	PWR401ML	PWR401MH	PWR401H		
<b>Output</b>						
Rating	Output voltage *1	40 V	80 V	240 V	650 V	
	Output current *1	40 A	20 A	5 A	1.85 A	
	Output power	400 W				
Voltage	Maximum settable voltage *2	42 V	84 V	252 V	682.5 V	
	Setting accuracy	± (0.05 % of set + 0.05 % of rating)				
	Resolution		200 mV	400 mV	1000 mV	2500 mV
		Using FINE, OUT OFF	10 mV	10 mV	100 mV	100 mV
		Using FINE, OUT ON	1 mV	1 mV	10 mV	10 mV
	When using a communication interface	0.1 mV	0.1 mV	0.1 mV	0.1 mV	
	Line regulation *3	±6 mV	±10 mV	±26 mV	±67 mV	
	Load regulation *4	±6 mV	±10 mV	±26 mV	±67 mV	
	Transient response *5	1 ms or less	2 ms or less	2 ms or less	3 ms or less	
	Ripple noise *6	p-p *7	50 mV	50 mV	100 mV	300 mV
		rms *8	5 mV	5 mV	20 mV	50 mV
	Rise time	At full load	50 ms or less		100 ms or less	
		No load	50 ms or less		100 ms or less	
Fall time *9	At full load	50 ms or less		150 ms	250 ms	
	No load	500 ms or less		1200 ms	2000 ms	
Maximum remote sensing compensation voltage (single line)	1.5 V	4 V	5 V	5 V		
Temperature coefficient *10	100 ppm/°C					
Current	Maximum settable current *2	42 A	21 A	5.25 A	1.9425 A	
	Setting accuracy *11	± (0.5 % of set + 0.1 % of rating)				
	Resolution		200 mA	100 mA	20 mA	10 mA
		Using FINE, OUT OFF	10 mA	10 mA	1 mA	1 mA
		Using FINE, OUT ON	1 mA	1 mA	0.1 mA	0.1 mA
	When using a communication interface	0.1 mA	0.1 mA	0.1 mA	0.1 mA	
	Line regulation	±6 mA	±4 mA	±2.5 mA	±2.2 mA	
	Load regulation	±13 mA	±9 mA	±6.0 mA	±5.4 mA	
	Ripple noise *12	rms *8	80 mA	40 mA	12 mA	6 mA
	Rise time (TYP)	At full load	50 ms		100 ms	
	Fall time (TYP)	At full load	50 ms		100 ms	
	Temperature coefficient *10	100 ppm/°C				
	Maximum internal resistance that can be set	1.000 Ω	4.000 Ω	36.00 Ω	263.5 Ω	

\*1. The maximum output voltage and maximum output current are limited by the maximum output power.

\*2. Can be limited to approximately 95 % of the OVP trip point or OCP trip point.

\*3. 85 Vac to 135 Vac or 170 Vac to 265 Vac, fixed load

\*4. The amount of change that occurs when the load is changed from no load to full load (rated output power/rated output voltage) with rated output voltage. The value is measured at the sensing point.

\*5. The amount of time required for the output voltage to return to a value within "rated output voltage ± (0.1 % + 10 mV)." The load current fluctuation is 50 % to 100 % of the maximum current with the set output voltage.

\*6. Measured using an RC-9131C probe that conforms to the JEITA specifications. At the rated output current.

\*7. When the measurement frequency bandwidth is 10 Hz to 20 MHz.

\*8. When the measurement frequency bandwidth is 10 Hz to 1 MHz.

\*9. When the bleeder circuit is set to bleeder normal.

\*10. When the ambient temperature is within 0 °C and 50 °C

\*11. Applies to the range of 1 % to 100 % of the rated current. TYP (0.1 % of rating) for 0 % to 1 %.

\*12. When the output voltage is 10 % to 100 % of the rating. At the rated output current.

Item/Model	PWR401L	PWR401ML	PWR401MH	PWR401H
<b>Display function</b>				
Voltage display	Maximum display	99.99		999.9
	Display accuracy	± (0.2 % of reading + 5 digit)		
Current display	Maximum display	99.99		9.999
	Display accuracy	± (0.5 % of reading + 8 digit)		
Power display	The PWR DSPL LED lights in red.			
	Maximum display	9999		
	Display accuracy	Displays the result of multiplying the current and voltage. The display is toggled with the voltage or current display.		



● 800 W model

Item/Model	PWR801L	PWR801ML	PWR801MH	PWR801H
<b>AC input</b>				
Nominal input rating	100 Vac to 240 Vac, 50 Hz to 60 Hz, single phase			
Input voltage range	85 Vac to 265 Vac			
Input frequency range	47 Hz to 63 Hz			
Current (TYP) *1	100 Vac	11.2 A		
	200 Vac	5.6 A		
Inrush current (MAX) *2	50 A peak or less			
Power (MAX) *3	1120 VA			
Power factor (TYP) *1	0.99 (input voltage: 100 V), 0.97 (input voltage: 200 V)			
Efficiency (MIN) *1	75 % (TYP)			
Hold-up time for power interruption (MIN) *3	20 ms or more			

\*1. At the rated output power for the rated output current.

\*2. Excludes the charge current component that flows through the capacitor of the internal EMC filter circuit immediately after the POWER switch is turned on (for approximately 1 ms).

\*3. 100 Vac, at the rated output power.

Item/Model	PWR801L	PWR801ML	PWR801MH	PWR801H		
<b>Output</b>						
Rating	Output voltage *1	40 V	80 V	240 V	650 V	
	Output current *1	80 A	40 A	10 A	3.70 A	
	Output power	800 W				
Voltage	Maximum settable voltage *2	42 V	84 V	252 V	682.5 V	
	Setting accuracy	± (0.05 % of set + 0.05 % of rating)				
	Resolution		200 mV	400 mV	1000 mV	2500 mV
		Using FINE, OUT OFF	10 mV	10 mV	100 mV	100 mV
		Using FINE, OUT ON	1 mV	1 mV	10 mV	10 mV
		When using a communication interface	0.1 mV	0.1 mV	0.1 mV	0.1 mV
	Line regulation *3	±6 mV	±10 mV	±26 mV	±67 mV	
	Load regulation *4	±6 mV	±10 mV	±26 mV	±67 mV	
	Transient response *5	1 ms or less	2 ms or less	2 ms or less	3 ms or less	
	Ripple noise *6	p-p *7	50 mV	50 mV	100 mV	300 mV
		rms *8	5 mV	5 mV	20 mV	50 mV
	Rise time	At full load	50 ms or less		100 ms or less	
		No load	50 ms or less		100 ms or less	
	Fall time *9	At full load	50 ms or less		150 ms	250 ms
No load		500 ms or less		1200 ms	2000 ms	
Maximum remote sensing compensation voltage (single line)	1.5 V	4 V	5 V	5 V		
Temperature coefficient *10	100 ppm/°C					
Current	Maximum settable current *2	84 A	42 A	10.5 A	3.885 A	
	Setting accuracy *11	± (0.5 % of set + 0.1 % of rating)				
	Resolution		400 mA	200 mA	40 mA	20 mA
		Using FINE, OUT OFF	10 mA	10 mA	10 mA	1 mA
		Using FINE, OUT ON	1 mA	1 mA	1 mA	0.1 mA
		When using a communication interface	0.1 mA	0.1 mA	0.1 mA	0.1 mA
	Line regulation	±10 mA	±6 mA	±3 mA	±2.4 mA	
	Load regulation	±21 mA	±13 mA	±7 mA	±5.7 mA	
	Ripple noise *12	rms *8	160 mA	80 mA	24 mA	12 mA
	Rise time (TYP)	At full load	50 ms		100 ms	
	Fall time (TYP)	At full load	50 ms		100 ms	
Temperature coefficient *10	100 ppm/°C					
Maximum internal resistance that can be set	0.500 Ω	2.000 Ω	18.00 Ω	131.8 Ω		

\*1. The maximum output voltage and maximum output current are limited by the maximum output power.

\*2. Can be limited to approximately 95 % of the OVP trip point or OCP trip point.

\*3. 85 Vac to 135 Vac or 170 Vac to 265 Vac, fixed load

\*4. The amount of change that occurs when the load is changed from no load to full load (rated output power/rated output voltage) with rated output voltage. The value is measured at the sensing point.

\*5. The amount of time required for the output voltage to return to a value within "rated output voltage ± (0.1 % + 10 mV)." The load current fluctuation is 50 % to 100 % of the maximum current with the set output voltage.

\*6. Measured using an RC-9131C probe that conforms to the JEITA specifications. At the rated output current.

\*7. When the measurement frequency bandwidth is 10 Hz to 20 MHz.

\*8. When the measurement frequency bandwidth is 10 Hz to 1 MHz.

\*9. When the bleeder circuit is set to bleeder normal.

\*10. When the ambient temperature is within 0°C and 50 °C

\*11. Applies to the range of 1 % to 100 % of the rated current. TYP (0.1 % of rating) for 0 % to 1 %.

\*12. When the output voltage is 10 % to 100 % of the rating. At the rated output current.

Item/Model	PWR801L	PWR801ML	PWR801MH	PWR801H
<b>Display function</b>				
Voltage display	Maximum display	99.99		999.9
	Display accuracy	± (0.2 % of reading + 5 digit)		
Current display	Maximum display	99.99		9.999
	Display accuracy	± (0.5 % of reading + 8 digit)		
Power display	The PWR DSPL LED lights in red.			
	Maximum display	9999		
	Display accuracy	Displays the result of multiplying the current and voltage. The display is toggled with the voltage or current display.		

# Specifications

## ● 1200 W model

Item/Model	PWR1201L	PWR1201ML	PWR1201MH	PWR1201H
<b>AC input</b>				
Nominal input rating	100 Vac to 240 Vac, 50 Hz to 60 Hz, single phase			
Input voltage range	85 Vac to 265 Vac			
Input frequency range	47 Hz to 63 Hz			
Current (TYP) *1	100 Vac	16.8 A		
	200 Vac	8.4 A		
Inrush current (MAX) *2	75 A peak or less			
Power (MAX) *3	1680 VA			
Power factor (TYP) *1	0.99 (input voltage: 100 V), 0.97 (input voltage: 200 V)			
Efficiency (MIN) *1	75 % (TYP)			
Hold-up time for power interruption (MIN) *3	20 ms or more			

\*1. At the rated output power for the rated output current.

\*2. Excludes the charge current component that flows through the capacitor of the internal EMC filter circuit immediately after the POWER switch is turned on (for approximately 1 ms).

\*3. 100 Vac, at the rated output power.

Item/Model	PWR1201L	PWR1201ML	PWR1201MH	PWR1201H		
<b>Output</b>						
Rating	Output voltage *1	40 V	80 V	240 V	650 V	
	Output current *1	120 A	60 A	15.0 A	5.55 A	
	Output power	1200 W				
Voltage	Maximum settable voltage *2	42 V	84 V	252 V	682.5 V	
	Setting accuracy	± (0.05 % of set + 0.05 % of rating)				
	Resolution		200 mV	400 mV	1000 mV	2500 mV
		Using FINE, OUT OFF	10 mV	10 mV	100 mV	100 mV
		Using FINE, OUT ON	1 mV	1 mV	10 mV	10 mV
		When using a communication interface	0.1 mV	0.1 mV	0.1 mV	0.1 mV
	Line regulation *3	±6 mV	±10 mV	±26 mV	±67 mV	
	Load regulation *4	±6 mV	±10 mV	±26 mV	±67 mV	
	Transient response *5	1 ms or less	2 ms or less	2 ms or less	3 ms or less	
	Ripple noise *6	p-p *7	50 mV	50 mV	100 mV	300 mV
		rms *8	5 mV	5 mV	20 mV	50 mV
	Rise time	At full load	50 ms or less		100 ms or less	
		No load	50 ms or less		100 ms or less	
	Fall time *9	At full load	50 ms or less		150 ms	250 ms
No load		500 ms or less		1200 ms	2000 ms	
Maximum remote sensing compensation voltage (single line)	1.5 V	4 V	5 V	5 V		
Temperature coefficient *10	100 ppm/°C					
Current	Maximum settable current *2	126 A	63 A	15.75 A	5.8275 A	
	Setting accuracy *11	± (0.5 % of set + 0.1 % of rating)				
	Resolution		600 mA	300 mA	60 mA	30 mA
		Using FINE, OUT OFF	100 mA	10 mA	10 mA	1 mA
		Using FINE, OUT ON	10 mA	1 mA	1 mA	0.1 mA
		When using a communication interface	0.1 mA	0.1 mA	0.1 mA	0.1 mA
	Line regulation	±14 mA	±8 mA	±3.5 mA	±2.6 mA	
	Load regulation	±29 mA	±17 mA	±8.0 mA	±6.1 mA	
	Ripple noise *12	rms *8	240 mA	120 mA	36 mA	18 mA
	Rise time (TYP)	At full load	50 ms		100 ms	
	Fall time (TYP)	At full load	50 ms		100 ms	
Temperature coefficient *10	100 ppm/°C					
Maximum internal resistance that can be set	0.333 Ω	1.333 Ω	12.00 Ω	87.84 Ω		

\*1. The maximum output voltage and maximum output current are limited by the maximum output power.

\*2. Can be limited to approximately 95 % of the OVP trip point or OCP trip point.

\*3. 85 Vac to 135 Vac or 170 Vac to 265 Vac, fixed load

\*4. The amount of change that occurs when the load is changed from no load to full load (rated output power/rated output voltage) with rated output voltage. The value is measured at the sensing point.

\*5. The amount of time required for the output voltage to return to a value within "rated output voltage ± (0.1 % + 10 mV)." The load current fluctuation is 50 % to 100 % of the maximum current with the set output voltage.

\*6. Measured using an RC-9131C probe that conforms to the JEITA specifications. At the rated output current.

\*7. When the measurement frequency bandwidth is 10 Hz to 20 MHz.

\*8. When the measurement frequency bandwidth is 10 Hz to 1 MHz.

\*9. When the bleeder circuit is set to bleeder normal.

\*10. When the ambient temperature is within 0 °C and 50 °C

\*11. Applies to the range of 1 % to 100 % of the rated current. TYP (0.1 % of rating) for 0 % to 1 %.

\*12. When the output voltage is 10 % to 100 % of the rating. At the rated output current.

Item/Model	PWR1201L	PWR1201ML	PWR1201MH	PWR1201H	
<b>Display function</b>					
Voltage display	Maximum display	99.99		999.9	
	Display accuracy	± (0.2 % of reading + 5 digit)			
Current display	Maximum display	999.9	99.99	9.999	
	Display accuracy	± (0.5 % of reading + 8 digit)			
Power display	The PWR DSPL LED lights in red.				
	Maximum display	9999			
	Display accuracy	Displays the result of multiplying the current and voltage. The display is toggled with the voltage or current display.			

● 2000 W model **NEW**

Item/Model	PWR2001L	PWR2001ML	PWR2001MH	PWR2001H
<b>AC input</b>				
Nominal input rating	100 Vac to 240 Vac, 50 Hz to 60 Hz, single phase			
Input voltage range	85 Vac to 265 Vac			
Input frequency range	47 Hz to 63 Hz			
Current (TYP) *1	100 Vac	28.0 A		
	200 Vac	14.0 A		
Inrush current (MAX)	125 Apeak or less			
Power (MAX) *2	2800 VA			
Power factor (TYP) *1	0.99 (input voltage: 100 V), 0.97 (input voltage: 200 V)			
Efficiency (MIN) *1	75 % (TYP)			
Hold-up time for power interruption (MIN) *2	20 ms or more			

\*1. At the rated output power for the rated output current.

\*2. 100 Vac, at the rated output power.

Item/Model	PWR2001L	PWR2001ML	PWR2001MH	PWR2001H		
<b>Output</b>						
Rating	Output voltage *1	40 V	80 V	240 V	650 V	
	Output current *1	200 A	100 A	25.0 A	9.25 A	
	Output power	2000 W				
Voltage	Maximum settable voltage *2	42 V	84 V	252 V	682.5 V	
	Setting accuracy	± (0.05 % of set + 0.05 % of rating)				
	Resolution		200 mV	400 mV	1000 mV	2500 mV
		Using FINE, OUT OFF	10 mV	10 mV	100 mV	100 mV
		Using FINE, OUT ON	1 mV	1 mV	10 mV	10 mV
		When using a communication interface	0.1 mV	0.1 mV	0.1 mV	0.1 mV
	Line regulation *3	±6 mV	±10 mV	±26 mV	±67 mV	
	Load regulation *4	±6 mV	±10 mV	±26 mV	±67 mV	
	Transient response *5	1 ms or less	2 ms or less	2 ms or less	3 ms or less	
	Ripple noise *6	p-p *7	50 mV	70 mV	120 mV	350 mV
		rms *8	5 mV	5 mV	20 mV	50 mV
	Rise time	At full load	50 ms or less		100 ms or less	
		No load	50 ms or less		100 ms or less	
	Fall time *9	At full load	50 ms or less		150 ms or less	
		No load	500 ms or less		1200 ms or less	
Maximum remote sensing compensation voltage (single line)	1.5 V	4 V	5 V	5 V		
Temperature coefficient *10	100 ppm/°C					
Current	Maximum settable current *2	210 A	105 A	26.25 A	9.7125 A	
	Setting accuracy *11	± (0.5 % of set + 0.1 % of rating)				
	Resolution		1000 mA	500 mA	100 mA	50 mA
		Using FINE, OUT OFF	100 mA	100 mA	10 mA	10 mA
		Using FINE, OUT ON	10 mA	10 mA	1 mA	1 mA
		When using a communication interface	0.1 mA	0.1 mA	0.1 mA	0.1 mA
	Line regulation	±22 mA	±12 mA	±4.5 mA	±2.9 mA	
	Load regulation	±45 mA	±25 mA	±10.0 mA	±6.9 mA	
	Ripple noise *12	rms *8	400 mA	200 mA	60 mA	30 mA
	Rise time (TYP)	At full load	50 ms		100 ms	
	Fall time (TYP)	At full load	50 ms		100 ms	
Temperature coefficient *10	100 ppm/°C					
Maximum internal resistance that can be set	0.200 Ω	0.800 Ω	7.200 Ω	52.70 Ω		

\*1. The maximum output voltage and maximum output current are limited by the maximum output power.

\*2. Can be limited to approximately 95 % of the OVP trip point or OCP trip point.

\*3. 85 Vac to 135 Vac or 170 Vac to 265 Vac, fixed load

\*4. The amount of change that occurs when the load is changed from no load to full load (rated output power/rated output voltage) with rated output voltage. The value is measured at the sensing point.

\*5. The amount of time required for the output voltage to return to a value within "rated output voltage ± (0.1 % + 10 mV)." The load current fluctuation is 50 % to 100 % of the maximum current with the set output voltage.

\*6. Measured using an RC-9131C probe that conforms to the JEITA specifications. At the rated output current.

\*7. When the measurement frequency bandwidth is 10 Hz to 20 MHz.

\*8. When the measurement frequency bandwidth is 10 Hz to 1 MHz.

\*9. When the bleeder circuit is set to bleeder normal.

\*10. When the ambient temperature is within 0°C and 50 °C

\*11. Applies to the range of 1 % to 100 % of the rated current. TYP (0.1 % of rating) for 0 % to 1 %.

\*12. When the output voltage is 10 % to 100 % of the rating. At the rated output current.

Item/Model	PWR2001L	PWR2001ML	PWR2001MH	PWR2001H
<b>Display function</b>				
Voltage display	Maximum display	99.99		999.9
	Display accuracy	± (0.2 % of reading + 5 digit)		
Current display	Maximum display	999.9		99.99
	Display accuracy	± (0.5 % of reading + 8 digit)		
Power display	The PWR DSPL LED lights in red.			
	Maximum display	9999		
	Display accuracy	Displays the result of multiplying the current and voltage. The display is toggled with the voltage or current display.		

# Specifications

## Common specifications

Item/Model	400 W	800 W	1200 W	2000 W
<b>Protection functions</b>				
Overvoltage protection (OVP)	Setting range	Turns the output off *1, displays OVP, and lights ALM 10 % to 112 % of the rated output voltage		
	Setting accuracy	± (1.5 % of rating)		
Overcurrent protection (OCP) *2	Setting range	Turns the output off *1, displays OCP, and lights ALM 10 % to 112 % of the rated output current		
	Setting accuracy	± (3 % of rating)		
Front-panel output terminal overcurrent protection (FOCP)*3	Value (fixed)	Turns the output off *1, displays FOCP, and lights ALM 11 A (TYP)		
	Setting range	Cannot be set to a value less than or equal to the set voltage 0 % to 105 % of the rated output voltage		
Overheat protection (OHP)	Turns the output off, displays OHP, and lights ALM			
Incorrect sensing connection protection (SENSE)	Turns the output off, displays SENS, and lights ALM			
Low AC input protection (AC-FAIL)	Turns the output off *4, displays AC, and lights ALM			
Shutdown (SD)	Turns the output off *1, displays SD, and lights ALM			
Power limit (POWER LIMIT)	ALM blinking			
	Value (fixed)	Approx. 105% of the rated output power		
Communication monitoring (watchdog)	Turns the output off, displays WDOG, and lights ALM			
Master-slave parallel operation protection (PRL ALM)	Turns the output off *1, displays PRL, and lights ALM			

\*1. Output off or breaker trip on the 2000 W model.

\*2. This does not protect against the discharge current peak that is generated from the capacitors inside the PWR-01 output section when the load is changed suddenly.

\*3. Available on models with a maximum settable current of 11 A or more. If the OCP value is less than the FOCP value, the OCP value takes precedence.

\*4. Auto recovery after eliminating the cause of the alarm is selectable.

Item/Model	400 W	800 W	1200 W	2000 W
<b>Signal output and input</b>				
Monitor signal output	Voltage monitor (VMON)	Selectable monitor voltage range: 0 V to 5 V or 0 V to 10 V		
		Setting accuracy	2.5 % of f.s. *1	
	Current monitor (IMON)	Selectable monitor voltage range: 0 V to 5 V or 0 V to 10 V		
		Setting accuracy	2.5 % of f.s. *1	
Status signal output *2	OUTON STATUS	On when output is on.		
	CV STATUS	Turns on during CV operation		
	CC STATUS	Turns on during CC operation		
	ALARM STATUS	Turns on when an alarm has been activated		
	POWER ON STATUS	Turns on when the power is turned on		
Trigger signal	Input (TRG IN)	Logic selectable: LOW (0 V to 1.5 V), HIGH (3.5 V to 5 V)		
		Input impedance: 10 kΩ (TYP)		
	Output (TRG OUT)	Logic selectable: LOW (0 V to 0.6 V), HIGH (4.2 V to 5 V)		
		Pulse width: 100 μs (TYP)		

\*1. f.s. is the full scale at the selected range. It is 10 V for the 10 V range and 5 V for the 5 V range.

\*2. Photocoupler open collector output; maximum voltage 30 V, maximum current (sink) 8 mA; isolated from the output and control circuits; status commons are floating (withstand voltage of less than or equal to 60 V); and status signals are not mutually isolated.

Item/Model	400 W	800 W	1200 W	2000 W
<b>Control functions</b>				
Output voltage control (VPGM)	0 % to 100 % of the rated output voltage			
	Accuracy	Selectable control voltage range: 0 V to 5 V or 0 V to 10 V 5 % of rating		
Output current control (IPGM)	0 % to 100 % of the rated output current			
	Accuracy	Selectable control voltage range: 0 V to 5 V or 0 V to 10 V 5 % of rating		
External control	Output on/ off control OUTPUT ON/OFF CONT	Logic selectable: Output on when set to LOW (0 V to 0.5 V) or shorted; output off when set to HIGH (4.5 V or 5 V) or open		
		Output on when set to HIGH (4.5 V to 5 V) or open; output off when set to LOW (0 V or 0.5 V) or shorted		
	Output shutdown control SHUT DOWN	Output on when set to LOW (0 V to 0.5 V) or shorted		
	Alarm clear control ALM CLR	Alarm cleared when set to LOW (0 V to 0.5 V) or shorted		

Item/Model	400 W	800 W	1200 W	2000 W
<b>Other functions</b>				
Output-on/ off delay	Setting range: 0.0 s, 0.5 s to 99.9 s *1 setting resolution: 0.1 s			
Soft start and soft stop	Setting range: 0.0 s, 0.5 s to 10.0 s *1 setting resolution: 0.1 s			
Overcurrent protection (OCP) activation delay	Setting range: 0.0 s to 2.0 s *1 setting resolution: 0.1 s			
Preset memory	Up to three sets of the following settings can be saved: the set voltage, the set current, the set OVP, the set OCP, and the set UVL.			
Key lock	Locks the operation of all keys other than the OUTPUT key.			
CONFIG shortcut	Up to three CONFIG parameters can be registered to the SC1, SC2, and SC3 keys			
Sequence	Number of programs: 1			
	Number of steps: 64			
	Repetition count: 1 to 99998, INFINITY			
	Number of configurable interval loops: 16			
Synchronized Operation	Number of interval loops: 2 to 99998			
	Step time: 0.1 s to 100 h (common to step transition and ramp transition)			
Synchronization of voltage and current settings, synchronization of the resumption of steps in a sequence program				
Master-slave parallel operation *2	Up to three units (same models) including the master unit	Up to two units (same models) including the master unit		
Series operation *3	Two units (the same model)			
Multichannel (VMCB)	Connection between the master unit and PC	LAN, USB, RS232C		
	Connection with slave units	LAN		

\*1. Factory default is 0.0 s.

\*2. Current difference between the master and slaves is 5 % (TYP).

\*3. H type is excluded

Item/Model	400 W	800 W	1200 W	2000 W
<b>Operation display</b>				
OUTPUT ON/ OFF	OUTPUT LED lights green when the output is on.			
Output-on/ off delay	"DLY" lights when it is set and blinks when it is in effect. OUTPUT LED blinks orange while output-on delay is in effect.			
Soft start and soft stop	OUTPUT LED blinks green while output-off delay is in effect.			
CV operation	"SS" lights when it is set and blinks when it is in effect. OUTPUT LED lights green when soft start is in effect. OUTPUT LED blinks green when soft stop is in effect.			
CC operation	CV LED lights in green.			
Alarm operation	CC LED lights in red.			
Alarm operation	ALM LED lights in red when a protection function has been activated.			
	ALM LED blinks red when the power limit (POWER LIMIT) is activated. OUTPUT LED blinks orange when a protection function is activated when the output is on.			
Preset memory	PRESET A, B, or C LED lights green when a preset memory entry is being recalled or saved.			
Key lock operation	LOCK LED lights green when the keys are locked.			
Remote operation	REMOTE LED lights green during remote control.			
LAN operation	LAN LED lights or blinks depending on the status. No fault status: Lights green.			
	Fault status: red. Standby status: Lights orange. WEB identify status: Blinks green.			
Bleeder circuit	"HB" lights when the hyper bleeder is set.			
Variable internal resistance (VIR)	"VIR" lights when it is set.			
Sequence	"SEQ" lights when a sequence is being executed and blinks the PWR-01 is waiting for a trigger.			



## ● Common specifications

Item/Model	400 W	800 W	1200 W	2000 W	
<b>Interface</b>					
Common specifications	Software protocol	IEEE Std 488.2-1992			
	Command language	Complies with SCPI Specification 1999.0			
RS232C	Hardware	Complies with the EIA232D specifications (excluding the connector)			
		RJ-45 connector (male) *1			
		Baud rate: 1200, 2400, 4800, 9600, 19200, 38400, 57600, 115200 bps			
		Data length: 8 bits, Stop bits: 1 bit, Parity bit: None			
		No flow control			
	Program message terminator	LF during reception, CR/LF during transmission			
USB	Hardware	Complies with the USB 2.0 specifications; data rate: 480 Mbps (HighSpeed)			
		Socket B type			
	Program message terminator	LF or EOM during reception, LF + EOM during transmission			
	Device class	Complies with the USBTMC-USB488 device class specifications			
LAN	Hardware	IEEE 802.3 100Base-TX/10Base-T Ethernet			
		Complies with LXI Specification 2011 Ver.1.4			
		Complies with LXI HiSLIP Extended Function Rev.1.01			
	Communication protocol	IPv4, RJ-45 connector *2			
	Program message terminator	VXI-11, SCPI-RAW, HiSLIP			
	Program message terminator	VXI-11, HiSLIP: LF or END during reception, LF + END during transmission SCPI-RAW: LF during reception, LF during transmission.			

\*1. The RD-8P/9P adapter cable is an option.

\*2. Category 5; use a straight cable.

Item/Model	400 W	800 W	1200 W	2000 W	
<b>General</b>					
Weight (main unit only)	Approx. 3 kg (6.61 lb)	Approx. 5.5 kg (12.13 lb)	Approx. 7.5 kg (16.53 lb)	Approx. 13 kg (28.66 lb)	
<b>Dimensions</b>					
See the outline drawing.					
Environmental conditions	Operating environment	Indoor use, overvoltage category II			
	Operating temperature	0 °C to +50 °C (32 °F to +122 °F)			
	Operating humidity	20 %rh to 85 %rh (no condensation)			
	Storage temperature	-25 °C to +60 °C (-13 °F to 140 °F)			
	Storage humidity	90 %rh or less (no condensation)			
	Altitude	Up to 2000 m			
Cooling method					
Forced air cooling using fan					
Grounding polarity					
Negative grounding or positive grounding possible					
Isolation voltage					
L/ ML/ MH type: ±500 Vmax H type: ±800 Vmax					
With-standing voltage	Across the primary circuit and chassis	No abnormalities when 1500 Vac is applied for 1 minute			
	Across the primary and secondary circuits	L/ ML/ MH type: No abnormalities when 1650 Vac is applied for 1 minute H type: No abnormalities when 1900 Vac is applied for 1 minute			
	Across the secondary circuit and chassis	L/ ML/ MH type: No abnormalities when 2300 Vdc is applied for 1 minute H type: No abnormalities when 2640 Vdc is applied for 1 minute			
Insulation resistance	Across the primary circuit and chassis	100 MΩ or more (70 % or less) at 500 Vdc			
	Across the primary and secondary circuits	LL/ ML/ MH type: 100 MΩ or more (70 % or less) at 500 Vdc H type: 100 MΩ or more (70 % or less) at 1000 Vdc			
	Across the secondary circuit and chassis	L/ ML/ MH type: 40 MΩ or more (70 % or less) at 500 Vdc H type: 40 MΩ or more (70 % or less) at 1000 Vdc			
<b>Accessories</b>					
<ul style="list-style-type: none"> <li>● Chassis connection short bar</li> <li>● Output terminal M4 screws (2 pcs.)</li> <li>● Output terminal bolt set (2 sets)</li> <li>M8 bolt set (For 400 W, 800 W and 1200 W model)</li> <li>M10 bolt set (For 2000 W model)</li> <li>*Only L type and ML type included.</li> <li>● Output terminal cover</li> <li>● Packing list</li> <li>● Safety Information</li> <li>● CD-ROM</li> <li>● Quick Reference (Japanese: 1 pc, English: 1 pc.)</li> <li>● Power cord</li> <li>*Included only with the 400 W/800 W model</li> <li>● Input terminal cover</li> <li>*Included only with the 1200 W model</li> <li>● Ferrite core set</li> <li>*Included only with the 1200 W model</li> </ul>					
<b>Electromagnetic compatibility (EMC)</b>					
Complies with the requirements of the following directive and standards. EMC Directive 2014/30/EU EN61326-1 (Class A *3), EN 55011 (Class A *3, Group 1 *4), EN 61000-3-2, EN 61000-3-3					
Applicable under the following conditions: The maximum length of all cabling and wiring connected to the product must be less than 3 m.					
<b>Safety *1</b>					
Complies with the requirements of the following directive and standards. Low Voltage Directive 2014/35/EU *2 EN 61010-1 (Class I *5, Pollution Degree 2 *6)					

\*1. Does not apply to specially ordered or modified products.

\*2. Limited to products that have a CE mark. Does not apply unless a core is attached to the J1 connector cable.

\*3. This is a Class A instrument. This product is intended for use in an industrial environment. This product may cause interference if used in residential areas. Such use must be avoided unless the user takes special measures to reduce electromagnetic emissions to prevent interference to the reception of radio and television broadcasts.

\*4. This is a Group 1 instrument. This product does not generate and/or use intentionally radio-frequency energy, in the form of electromagnetic radiation, inductive and/or capacitive coupling, for the treatment of material or inspection/analysis purpose.

\*5. This is a Class I instrument. Be sure to ground this product's protective conductor terminal. The safety of this product is guaranteed only when the product is properly grounded.

\*6. Pollution is addition of foreign matter (solid, liquid or gaseous) that may produce a reduction of dielectric strength or surface resistivity. Pollution Degree 2 assumes that only non-conductive pollution will occur except for an occasional temporary conductivity caused by condensation.

## Options

### AC power cord for 1200 W model

**AC5.5-3P3M-M4C-VCTF**

(not CE compliant) Total length 3 m.

### AC power cord for 2000 W model

**AC5.5-1P3M-M6C-3S**

(CE compliant) Total length 3 m.



AC5.5-3P3M-M4C-VCTF

### J1/ J2 connector plug kit

**OP01-PWR-01**

A plug kit for externally controlling the PWR through the J1/ J2 connector.  
(30 pin pieces. Housing for the J1 connector and J2 connector, 1 piece each)

### Parallel operation cable (for 2 units in parallel)

**OP02-PWR-01**

### External control cable and connector set

**OP03-PWR-01**

Cables 20 pcs., length: approx. 500 mm (Crimped on one end)  
Housing for the J1 connector and J2 connector: 1 piece each, Core: 1 piece



OP01-PWR-01

OP02-PWR-01

OP03-PWR-01

### RS232C control conversion cable

**RD-8P/9P**

### Safety plugs

**TL41 (screw connection type)**

**TL42 (solder connection type)**



TL41

TL42

## Application software



## Sequence Creation Software SD027-PWR-01 (Wavy for PWR-01)

\*Compatible with 400 W, 800 W, 1200 W models only. (2000 W models to be covered later.)

**Software that supports automatic testing of a power supply, allowing you to create and edit sequence data with the click of a mouse!**

SD027-PWR-01 (Wavy for PWR-01) is an application software that supports sequence creation and the operation for Kikusui power supplies and electronic loads. Wavy allows you to create and edit sequences visually with the click of a mouse and doesn't require programming knowledge. Wavy allows you to control your power supply in almost the same way as a remote controller for monitoring voltage and current, logging, etc.

### [Operating environment, conditions]

- Number of power supplies or electronic loads that the Wavy can control is limited to one unit.
- When a VMCB connection is used, the slave units are controlled at the same time the master unit is controlled.
- CPU: Pentium 4 HT or better (Recommended: Core2 or better)
- CD-ROM: Necessary to install the "Wavy"
- Mouse: Necessary
- Monitor: 1024 x 768 dots or higher resolution
- Memory: 128MB or more
- Interfaces: LAN, USB, RS232C

### Terminal unit

**TU01-PWR-01**

A terminal unit for converting the J1 and J2 connectors of this product to the J1 connector of the Kikusui PWR Series Regulated DC Power Supplies.

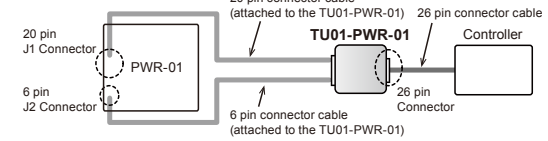

\*Output voltage (current) external resistance control and one-control parallel operation (series operation) cannot be converted.

### GPIB Converter

**PIA5100**

This converter converts RS232C or USB of the PWR-01 to GPIB, enabling connection of a remote controller using GPIB. [Accessories: Power cord set, Magnetic sheet]

\*DC 5 V (power supply with commercially-available universal AC adapter etc.) is required to operate the PIA5100.

[Connection example]

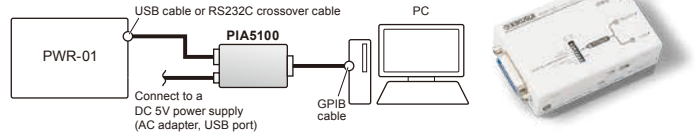

### Rack mount adapter / Rack mount bracket

For 400 W, 800 W and 1200 W model

**KRA3 (EIA inch racks) KRA150 (JIS millimeter racks)**

For 2000 W model

**KRB3-TOS (EIA inch racks) KRB150-TOS (JIS millimeter racks)**

1200 W model example

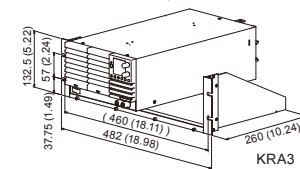

Unit: mm (inches)

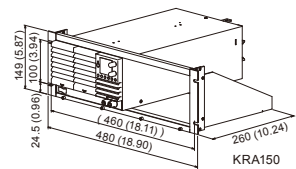

2000 W model example

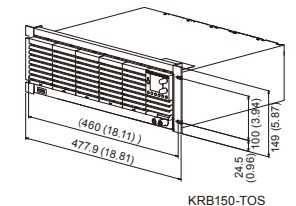
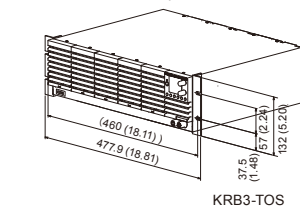

KRB3-TOS

KRB150-TOS

**Global commands can be used for batch control of VMCB-connected PWR-01 power supplies!**

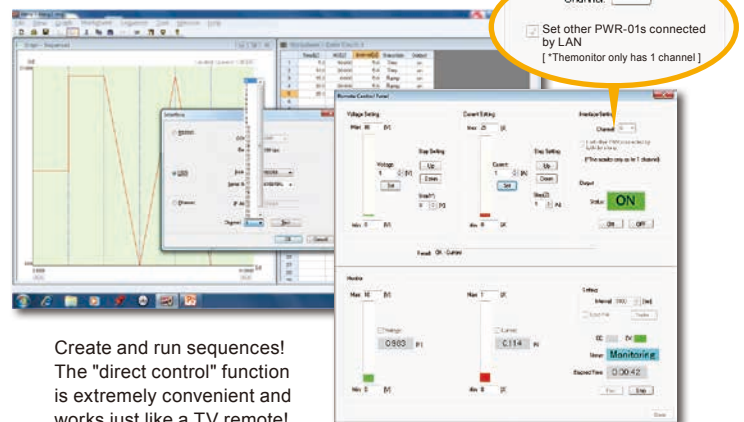

Create and run sequences!  
The "direct control" function is extremely convenient and works just like a TV remote!

\*Screen sample

■ Outline drawing (Unit mm (inches))

400 W model

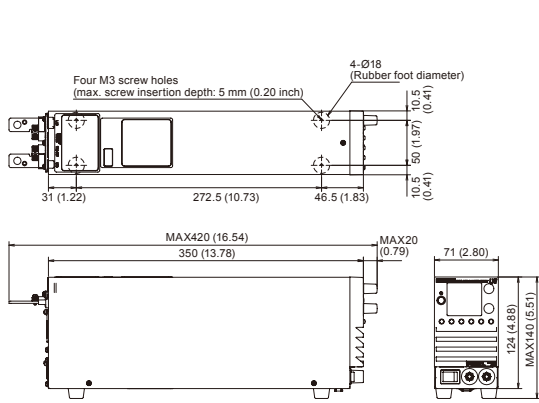

800 W model

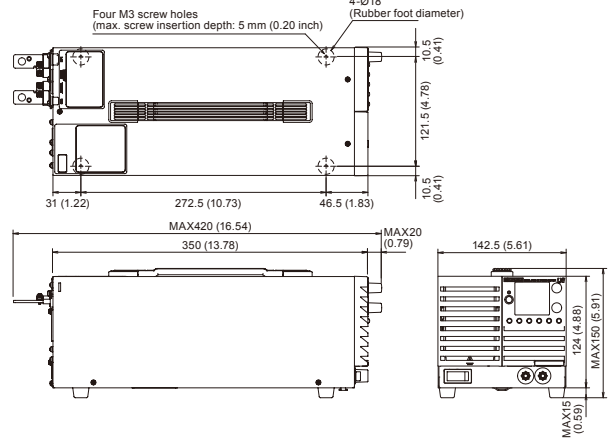

1200 W model

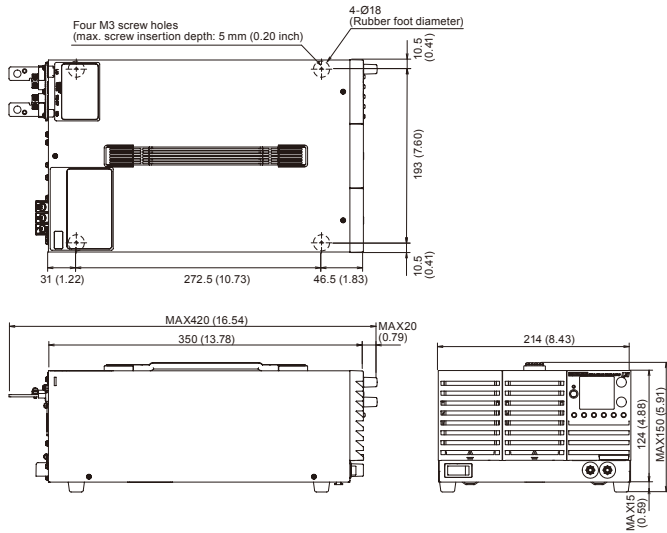

2000 W model

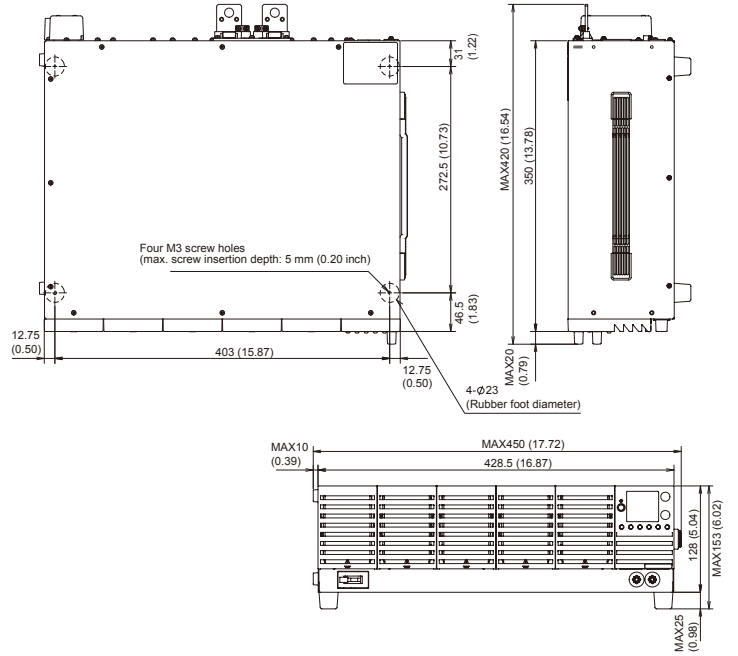

■ Rear panel



400 W model



800 W model



1200 W model



2000 W model

## ■ Ordering information

### Main unit

Product	Model	Output voltage (type)	Voltage variable range	Current variable range	Output power
Compact Wide-Range DC Power Supply	PWR401L	40 V (L)	0 V to 40 V	0 A to 40 A	400 W
	PWR801L			0 A to 80 A	800 W
	PWR1201L			0 A to 120 A	1200 W
	PWR2001L			0 A to 200 A	2000 W
	PWR401ML	80 V (ML)	0 V to 80 V	0 A to 20 A	400 W
	PWR801ML			0 A to 40 A	800 W
	PWR1201ML			0 A to 60 A	1200 W
	PWR2001ML <b>NEW</b>			0 A to 100 A	2000 W
	PWR401MH	240 V (MH)	0 V to 240 V	0 A to 5 A	400 W
	PWR801MH			0 A to 10 A	800 W
	PWR1201MH			0 A to 15 A	1200 W
	PWR2001MH <b>NEW</b>			0 A to 25.0 A	2000 W
	PWR401H	650 V (H)	0 V to 650 V	0 A to 1.85 A	400 W
	PWR801H			0 A to 3.70 A	800 W
	PWR1201H			0 A to 5.55A	1200 W
	PWR2001H <b>NEW</b>			0 A to 9.25 A	2000 W

### Option

Product	Model	Remark
AC power cord	AC5.5-3P3M-M4C-VCTF	For the 1200 W model. Total length 3 m. (Not CE compliant)
	AC5.5-1P3M-M6C-3S	For the 2000 W model. Total length 3 m. (CE compliant)
J1/J2 connector plug kit	OP01-PWR-01	A plug kit for externally controlling the PWR-01 through the J1/J2 connector. 30 pin pieces. Housing for the J1 connector and J2 connector, 1 piece each.
Parallel operation cable	OP02-PWR-01	For 2 units in parallel (one slave unit). Length: Approx. 400 mm Core: 1 piece
External control cable and connector set	OP03-PWR-01	Crimped on one end Cables 20 pcs., length: approx. 500 mm Housing for the J1 connector and J2 connector, 1 piece each Core: 1 piece
RS232C control conversion cable	RD-8P/9P	
Sequence creation software	SD027-PWR-01	Wavy for PWR-01
Safety plugs	TL41	Screw connection type. Red and black, one set each.
	TL42	Solder connection type. Red and black, one set each.
Terminal unit	TU01-PWR-01	A terminal unit for converting the J1 and J2 connectors of this product to the J1 connector of the Kikusui PWR Series Regulated DC Power Supplies.
GPIO Converter	PIA5100	Power cord set: 1 set Magnetic sheet: 1 sheet
Rack mount adapter	KRA3	For 400 W, 800 W and 1200 W model. EIA inch racks
	KRA150	For 400 W, 800 W and 1200 W model. JIS millimeter racks
Rack mount bracket	KRB3-TOS	For 2000 W model. EIA inch racks
	KRB150-TOS	For 2000 W model. JIS millimeter racks

勝特力電材超市-龍山店 886-3-5773766  
 勝特力電材超市-光復店 886-3-5729570  
 勝特力電子(上海) 86-21-34970699  
 勝特力電子(深圳) 86-755-83298787  
<http://www.100y.com.tw>