

P2 V23079 Relay

2 pole telecom / signal relay, polarized,
Through Hole Type (THT) or
Surface Mount Technology (SMT),

Relay types: non-latching with 1 coil
latching with 2 coils
latching with 1 coil

ROHS compliant (Directive 2002/95/EC) as per
product date code 0427.

Features

- Standard telecom relay (ringing and test access)
- Slim line 15 x 7.5 mm, 0.590 x 0.295 inch
- Switching current 5 A
- 2 changeover contacts (2 form C / DPDT)
- Bifurcated contacts
- Immersion cleanable
- High sensitivity results in low nominal power consumption 140 mW for non-latching and latching with 2 coils 70 mW for latching with 1 coil
- For single coil version:
 - Surge voltage resistance between contact and coil for single coil version:
 - 2.5 kV (2 / 10 μ s) meets the Telcordia Requirement GR-1089
 - 1.5 kV (10 / 160 μ s) meets FCC Part 68

Typical applications

- Communications equipment linecard application (ringing and test access)
PABX
Voice over IP
- Office equipment
- Measurement and control equipment
- Automotive equipment
CAN bus, keyless entry, speaker switch
- Medical equipment
- Consumer electronics
Set Top Boxes, HiFi

Options

- 1500 Vrms between open contacts

勝特力材料 886-3-5753170
勝特力电子(上海) 86-21-34970699
勝特力电子(深圳) 86-755-83298787
[Http://www.100y.com.tw](http://www.100y.com.tw)

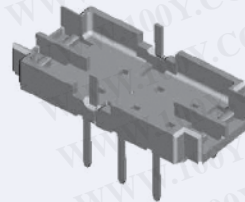
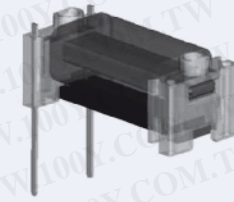
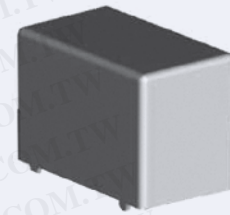

Insulation category

Basic insulation according	IEC / EN 60950
Working voltage	≤ 300 Vrms
Mains supply voltage	≤ 250 Vrms
Repetitive peak voltage	2500 V
Pollution degree	Internal: 1 External: 2
Flammability classification	V-0
Maximum operating temperature	85 °C

P2 V23079 Relay

Dimensions Dimensions in mm

	THT V23079-x1xxx-B301 standard coil		THT V23079-x2xxx-B301 overmolded coil		SMT long terminals V23079-x1xxx-B301 standard coil		SMT long terminals V23079-x2xxx-B301 overmolded coil		SMT short terminals V23079-x1xxx-B301 standard coil		SMT short terminals V23079-x2xxx-B301 overmolded coil	
	mm	inch	mm	inch	mm	inch	mm	inch	mm	inch	mm	inch
	L	14.5 ± 0.10	0.570 ± 0.004	14.6 ± 0.10	0.575 ± 0.004	14.5 ± 0.10	0.570 ± 0.004	14.6 ± 0.10	0.575 ± 0.004	14.5 ± 0.10	0.570 ± 0.004	14.6 ± 0.10
W	7.2 ± 0.10	0.283 ± 0.004	7.2 ± 0.10	0.283 ± 0.004	7.2 ± 0.10	0.283 ± 0.004	7.2 ± 0.10	0.283 ± 0.004	7.2 ± 0.10	0.283 ± 0.004	7.2 ± 0.10	0.283 ± 0.004
H	9.8 ± 0.10	0.385 ± 0.004	9.5 ± 0.10	0.374 ± 0.004	10.4 ± 0.15	0.409 ± 0.006	9.9 ± 0.10	0.390 ± 0.004	10.4 ± 0.15	0.409 ± 0.006	9.9 ± 0.10	0.390 ± 0.004
T	3.25 - 0.25	0.128 - 0.010	3.25 - 0.25	0.128 - 0.010	N/A	N/A	N/A	N/A	N/A	N/A	N/A	N/A
T1	N/A	N/A	N/A	N/A	5.52 ± 0.15	0.217 ± 0.006	5.52	0.217 ± 0.006	5.52	0.217 ± 0.006	5.52	0.217 ± 0.006
T2	N/A	N/A	N/A	N/A	9.4 ± 0.15	0.370 ± 0.006	9.4 ± 0.15	0.370 ± 0.006	7.4 ± 0.15	0.291 ± 0.006	7.4 ± 0.15	0.291 ± 0.006
Tw	0.5 ± 0.05	0.020 ± 0.002	0.5 ± 0.05	0.020 ± 0.002	0.5 ± 0.05	0.020 ± 0.002	0.5 ± 0.05	0.020 ± 0.002	0.5 ± 0.05	0.020 ± 0.002	0.5 ± 0.05	0.020 ± 0.002
S	0.55 - 0.15	0.022 - 0.006	0.45	0.018 ± 0.002	N/A	N/A	N/A	N/A	N/A	N/A	N/A	N/A

THT Version

SMT Version

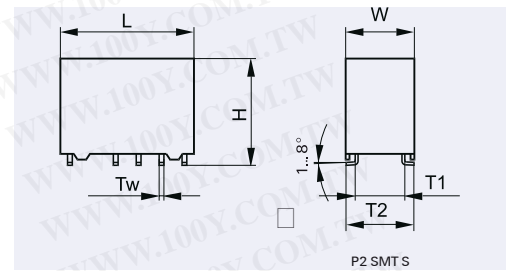
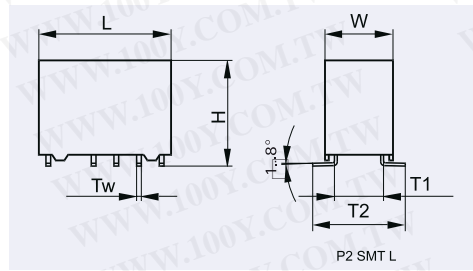
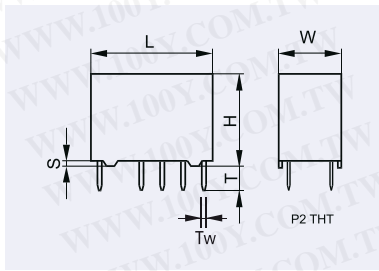

Mounting hole layout

View onto the component side of the PCB (top view)

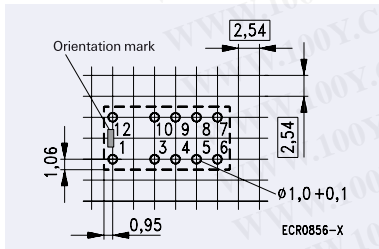

Note: Hole for pin 6 and 7 only for latching with 2 coils. Basic grid 2.54 mm

Solder pad layout

View onto the component side of the PCB (top view)

Long terminals

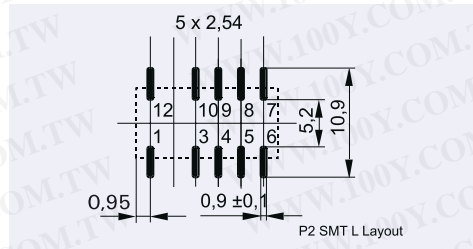

Note: Solder pad for pin 6 and 7 only for latching with 2 coils

Short terminals

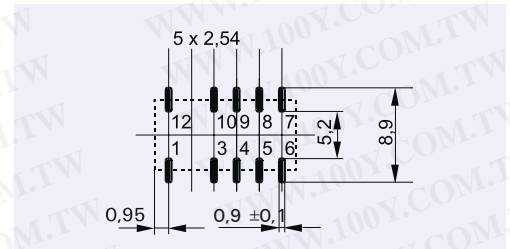

Note: Solder pad for pin 6 and 7 only for latching with 2 coils

Terminal assignment

Relay – top view

Non-latching type

not energized condition

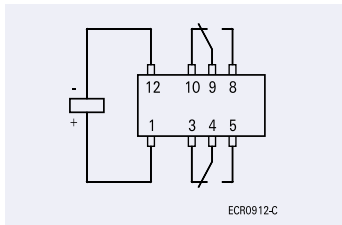

Latching type,

reset condition

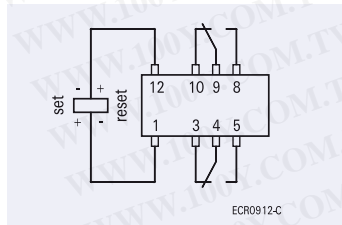

Latching, 2 coils

reset condition

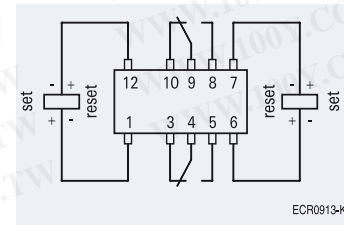

Contacts in reset position. Both coils can be used either as set or reset coils.

P2 V23079 Relay

Coil Operating Range

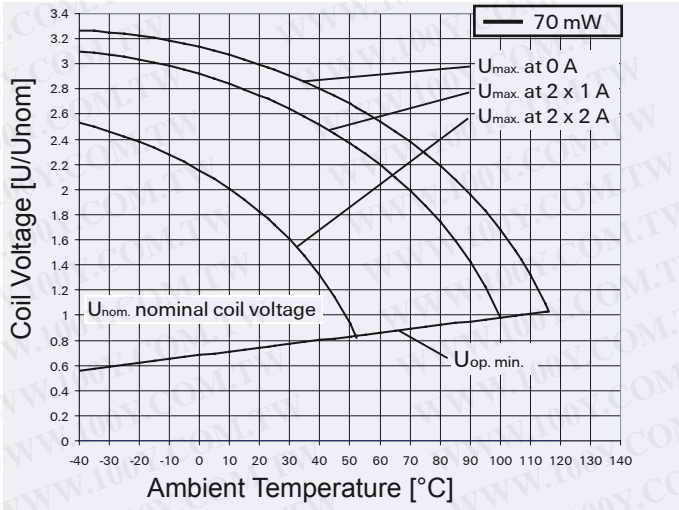

U_{nom} = Nominal coil voltage

U_{max.} = Upper limit of the operative range of the coil voltage (limiting voltage) when coils are continuously energized

U_{op. min.} = Lower limit of the operative range of the coil voltage (reliable operate voltage)

For latching relays U_{set min.} resp. U_{reset min.}

U_{rel. min.} = Lower limit of the operative range of the coil voltage (reliable release voltage)

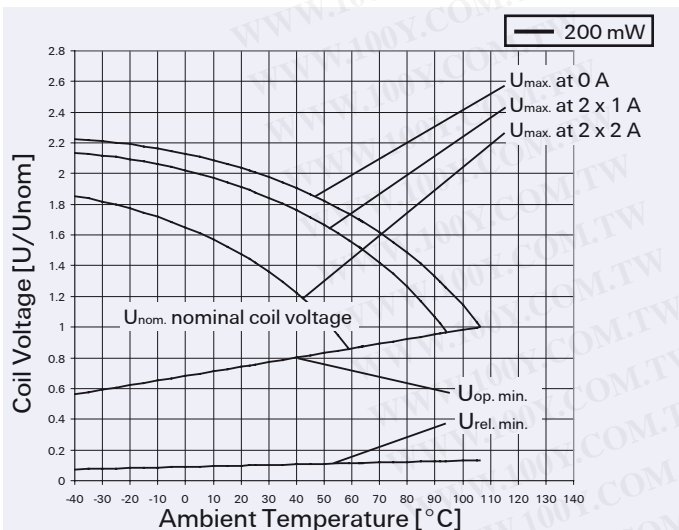
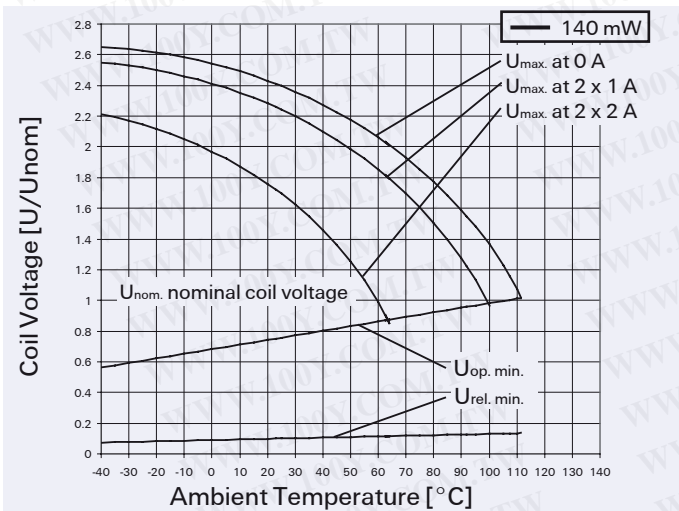

P2 V23079 Relay

Relay Code

Identification of the Miniature Relay P2



Relay type

THT version
A = non-latching, 1 coil
B = latching, 2 coils
C = latching, 1 coil

SMT version with long terminals
D = non-latching, 1 coil
E = latching, 2 coils
F = latching, 1 coil

SMT version with short terminals
G = non-latching, 1 coil
H = latching, 2 coils
J = latching, 1 coil

Coil type

1 = standard coil; B1, E1, F1, J1, H1
2 = overmolded coil, A1*, A2, C1*, D1*, D2, G1*, G2
(only non latching versions, i.e. relay type A, D, G)
*both standard and overmolded coil possible

Coil number

Non Latching, 1 coil
008 = 3 V nominal voltage
011 = 4.5 V
001 = 5 V
002 = 6 V
006 = 9 V
003 = 12 V
005 = 24 V

Latching, 1 coil
108 = 3 V nominal voltage
111 = 4.5 V
101 = 5 V
102 = 6 V
106 = 9 V
103 = 12 V
105 = 24 V

Latching, 2 coils
219 = 2.0 V
218 = 2.4 V nominal voltage
208 = 3 V
211 = 4.5 V
201 = 5 V
202 = 6 V
206 = 9 V
203 = 12 V
205 = 24 V

Contact arrangement / material

B301 = 2 changeover contacts; silver nickel, gold-plated, against silver nickel, gold-plated
B201 = 2 changeover contacts; silver palladium, gold-plated, against silver palladium

Ordering example: V23079-D2001-B301

Miniature relay P2 SMT version with long terminals (overmolded coil), non-latching, 1 coil, 5 V nominal voltage, 2 changeover contacts, silver nickel gold-covered contacts

P2 V23079 Relay

Coil Data (values at 23 °C)

Ordering Information

Nominal voltage U_{nom}	Operate/set voltage range		Release/ reset voltage Minimum	Coil power	Coil Resistance	Relay code	Tyco part number
	Minimum voltage U_{min}	Maximum voltage U_{max}					
Vdc	Vdc	Vdc	Vdc	mW	$\Omega / \pm 10\%$		

THT Standard, non-latching, standard 1 coil

3	2.25	6.50	0.30	140	64	V23079-A1008-B301	2-1393788-2
4	3.00	8.70	0.40	140	114	V23079-A1016-B301	2-1393788-9
4.5	3.38	9.80	0.45	140	145	V23079-A1011-B301	2-1393788-4
5	3.75	10.90	0.50	140	178	V23079-A1001-B301	1393788-3
6	4.50	13.00	0.60	140	257	V23079-A1002-B301	1393788-8
9	6.75	19.60	0.90	140	578	V23079-A1006-B301	2-1393788-0
12	9.00	26.15	1.20	140	1029	V23079-A1003-B301	1-1393788-1
24	18.00	52.30	2.40	140	4114	V23079-A1005-B301	1-1393788-6

THT non-latching, overmolded 1 coil

3	2.25	6.50	0.30	140	64	V23079-A2008-B301	6-1419120-6
4.5	3.38	9.80	0.45	140	145	V23079-A2011-B301	3-1393789-9
5	3.75	10.90	0.50	140	178	V23079-A2001-B301	3-1393789-5
6	4.50	13.00	0.60	140	257	V23079-A2002-B301	3-1393789-6
9	6.75	19.60	0.90	140	578	V23079-A2006-B301	3-1393789-8
12	9.00	26.15	1.20	140	1029	V23079-A2003-B301	3-1393789-7

THT latching, standard 2 coils

2.4	1.80	5.20	1.80	140	41	V23079-B1218-B301	1422002-8
3	2.25	6.50	2.25	140	64	V23079-B1208-B301	4-1393788-1
4.5	3.38	9.80	3.38	140	145	V23079-B1211-B301	4-1393788-2
5	3.75	10.90	3.75	140	178	V23079-B1201-B301	3-1393788-3
6	4.50	13.00	4.50	140	257	V23079-B1202-B301	3-1393788-5
9	6.75	19.60	6.75	140	578	V23079-B1206-B301	3-1393788-9
12	9.00	26.15	9.00	140	1029	V23079-B1203-B301	3-1393788-6
24	18.00	52.30	18.00	140	4114	V23079-B1205-B301	3-1393788-7

THT latching, overmolded 2 coils

2	1.50	4.30	1.50	140	28	V23079-B2219-B301	1-1422002-2
2.4	1.80	5.20	1.80	140	41	V23079-B2218-B301	1-1422002-1
3	2.25	6.50	2.25	140	64	V23079-B2208-B301	1-1422002-0
5	3.75	10.90	3.75	140	178	V23079-B2201-B301	1422002-9

THT latching, standard 1 coil

3	2.25	9.20	-2.25	70	128	V23079-C1108-B301	5-1393788-3
4.5	3.38	13.85	-3.38	70	289	V23079-C1111-B301	5-1393788-4
5	3.75	15.33	-3.75	70	357	V23079-C1101-B301	4-1393788-5
6	4.50	18.50	-4.50	70	514	V23079-C1102-B301	4-1393788-7
9	6.75	27.75	-6.75	70	1157	V23079-C1106-B301	5-1393788-1
12	9.00	37.00	-9.00	70	2057	V23079-C1103-B301	4-1393788-8
24	18.00	74.00	-18.00	70	8228	V23079-C1105-B301	5-1393788-0

SMT long pins, non-latching, standard 1 coil

3	2.25	6.50	0.30	140	64	V23079-D1008-B301	6-1393788-1
4.5	3.38	9.80	0.45	140	145	V23079-D1011-B301	6-1393788-2
5	3.75	10.90	0.50	140	178	V23079-D1001-B301	5-1393788-5
6	4.50	13.00	0.60	140	257	V23079-D1002-B301	5-1393788-6
9	6.75	19.60	0.90	140	578	V23079-D1006-B301	5-1393788-9
12	9.00	26.15	1.20	140	1029	V23079-D1003-B301	5-1393788-7
24	18.00	52.30	2.40	140	4114	V23079-D1005-B301	5-1393788-8

Further coil versions are available on request.

P2 V23079 Relay

Coil Data (values at 23 °C)

Ordering Information

Nominal voltage U_{nom}	Operate/set voltage range		Release/ reset voltage Minimum	Coil power	Coil Resistance	Relay code	Tyco part number
	Minimum voltage U_{min}	Maximum voltage U_{max}					
Vdc	Vdc	Vdc	Vdc	mW	$\Omega / \pm 10 \%$		

SMT long pins, non-latching, overmolded 1 coil

3	2.25	6.50	0.30	140	64	V23079-D2008-B301	4-1393789-7
4.5	3.38	9.80	0.45	140	145	V23079-D2011-B301	4-1393789-8
5	3.75	10.90	0.50	140	178	V23079-D2001-B301	4-1393789-3
6	4.50	13.00	0.60	140	257	V23079-D2002-B301	4-1393789-4
9	6.75	19.60	0.90	140	578	V23079-D2006-B301	4-1393789-6
12	9.00	26.15	1.20	140	1029	V23079-D2003-B301	4-1393789-5

SMT long pins, latching, standard 2 coils

2	1.50	4.33	1.50	140	28	V23079-E1219-B301	1-1422007-0
2.4	1.80	5.20	1.80	140	41	V23079-E1218-B301	1422007-5
3	2.25	6.50	2.25	140	64	V23079-E1208-B301	7-1393788-1
4.5	3.38	9.80	3.38	140	145	V23079-E1211-B301	7-1393788-2
5	3.75	10.90	3.75	140	178	V23079-E1201-B301	6-1393788-8
6	4.50	13.00	4.50	140	257	V23079-E1202-B301	1393789-5
9	6.75	19.60	6.75	140	578	V23079-E1206-B301	1393789-9
12	9.00	26.15	9.00	140	1029	V23079-E1203-B301	6-1393788-9
24	18.00	52.30	18.00	140	4114	V23079-E1205-B301	7-1393788-0

SMT long pins, latching, standard 1 coil

3	2.25	9.20	-2.25	70	128	V23079-F1108-B301	7-1393788-5
4.5	3.38	13.85	-3.38	70	289	V23079-F1111-B301	1-1393789-4
5	3.75	15.33	-3.75	70	357	V23079-F1101-B301	7-1393788-3
6	4.50	18.50	-4.50	70	514	V23079-F1102-B301	1-1393789-0
9	6.75	27.75	-6.75	70	1157	V23079-F1106-B301	1-1393789-2
12	9.00	37.00	-9.00	70	2057	V23079-F1103-B301	7-1393788-4
24	18.00	74.00	-18.00	70	8228	V23079-F1105-B301	1-1393789-1

SMT short pins, non-latching, standard 1 coil

3	2.25	6.50	0.30	140	64	V23079-G1008-B301	8-1393788-0
4.5	3.38	9.80	0.45	140	145	V23079-G1011-B301	1-1393789-7
5	3.75	10.90	0.50	140	178	V23079-G1001-B301	7-1393788-6
6	4.50	13.00	0.60	140	257	V23079-G1002-B301	1-1393789-5
9	6.75	19.60	0.90	140	578	V23079-G1006-B301	1-1393789-6
12	9.00	26.15	1.20	140	1029	V23079-G1003-B301	7-1393788-7
24	18.00	52.30	2.40	140	4114	V23079-G1005-B301	7-1393788-8

Further coil versions are available on request.

P2 V23079 Relay

Coil Data (values at 23 °C)

Ordering Information

Nominal voltage U_{nom}	Operate/set voltage range		Release/ reset voltage Minimum	Coil power	Coil Resistance	Relay code	Tyco part number
	Minimum voltage U_{min}	Maximum voltage U_{max}					
Vdc	Vdc	Vdc	Vdc	mW	$\Omega / \pm 10 \%$		

SMT short pins, non-latching, overmolded 1 coil

3	2.25	6.50	0.30	140	64	V23079-G2008-B301	5-1393789-4
4	3.00	8.70	0.40	140	114	V23079-G2016-B301	1393790-5
4.5	3.38	9.80	0.45	140	145	V23079-G2011-B301	5-1393789-5
5	3.75	10.90	0.50	140	178	V23079-G2001-B301	4-1393789-9
6	4.50	13.00	0.60	140	257	V23079-G2002-B301	5-1393789-0
9	6.75	19.60	0.90	140	578	V23079-G2006-B301	5-1393789-3
12	9.00	26.15	1.20	140	1029	V23079-G2003-B301	5-1393789-1

SMT short pins, latching, standard 2 coils

3	2.25	6.50	2.25	140	64	V23079-H1208-B301	2-1393789-4
4.5	3.38	9.80	3.38	140	145	V23079-H1211-B301	8-1393788-4
5	3.75	10.90	3.75	140	178	V23079-H1201-B301	2-1393789-0
6	4.50	13.00	4.50	140	257	V23079-H1202-B301	2-1393789-1
9	6.75	19.60	6.75	140	578	V23079-H1206-B301	2-1393789-3
12	9.00	26.15	9.00	140	1029	V23079-H1203-B301	8-1393788-3
24	18.00	52.30	18.00	140	4114	V23079-H1205-B301	2-1393789-2

SMT short pins, latching, standard 1 coils

3	2.25	9.20	-2.25	70	128	V23079-J1108-B301	2-1393789-9
4.5	3.38	13.85	-3.38	70	289	V23079-J1111-B301	3-1393789-0
5	3.75	15.33	-3.75	70	357	V23079-J1101-B301	2-1393789-5
6	4.50	18.50	-4.50	70	514	V23079-J1102-B301	2-1393789-6
12	9.00	37.00	-9.00	70	2057	V23079-J1103-B301	2-1393789-7
24	18.00	74.00	-18.00	70	8228	V23079-J1105-B301	2-1393789-8

High Dielectric Version

SMT short pins, non-latching, overmolded 1 coil

3	2.25	6.10	0.30	200	45	V23079-G2008-X079	1422006-5
5	3.75	10.10	0.50	200	125	V23079-G2001-X071	1422006-1
6	4.50	12.10	0.60	200	180	V23079-G2002-X072	1422006-2
9	6.75	18.20	0.90	200	405	V23079-G2006-X073	1422006-3
12	9.00	24.20	1.20	200	720	V23079-G2003-X074	1422006-4

Further coil versions are available on request.

P2 V23079 Relay

Contact Data

Number of contacts and type	2 changeover contacts
Contact assembly	Bifurcated contacts
Contact material	Silver nickel, gold-covered
Limiting continuous current at max. ambient temperature	2 A
Maximum switching current	5 A
Maximum switching voltage	220 Vdc 250 Vac
Maximum switching capacity	60 W, 62.5 VA
Thermoelectric potential	< 10 μ V
Minimum switching voltage	100 μ V
Initial contact resistance / measuring condition: 10 mA / 20 mV	< 50 m Ω
Electrical endurance at 12 V / 10 mA at 6 V / 100 mA at 60 V / 500 mA at 30 V / 1000 mA at 30 V / 2000 mA	typ. 5 x 10 ⁷ operations typ. 1 x 10 ⁷ operations typ. 5 x 10 ⁵ operations typ. 1 x 10 ⁶ operations typ. 2 x 10 ⁵ operations
Mechanical endurance	typ. 10 ⁸ operations
UL contact ratings	220 Vdc / 0.24 A - 60 W 125 Vdc / 0.24 A - 30 W 250 Vac / 0.25 A - 62.5 VA 125 Vac / 0.5 A - 62.5 VA 30 Vdc / 2 A - 60 W

Max. DC Load Breaking Capacity

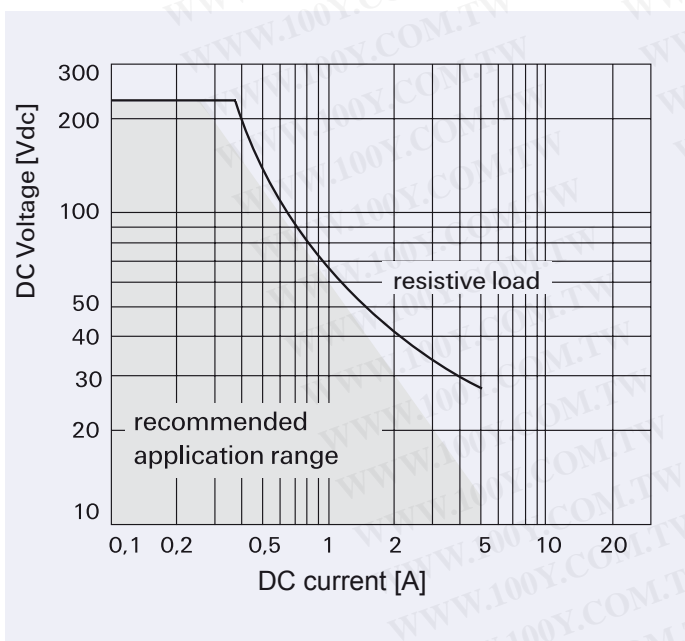

P2 V23079 Relay

Insulation

	Standard Version	High dielectric Version
Insulation resistance at 500 Vdc	> 10 ⁹ Ω	> 10 ⁹ Ω
Dielectric test voltage (1 min)		
between coil and contacts (Relay with 1 coil)	1500 Vrms	1500 Vrms
between adjacent contact sets	1000 Vrms	1500 Vrms
between open contacts	1000 Vrms	1500 Vrms
Surge voltage resistance		
according to Telcordia TR-NWT-001089 (2 / 10 μs)		
between coil and contacts (Relay with 1 coil)	2500 V	2500 V
between adjacent contact sets	2500 V	2500 V
between open contacts	2000 V	2500 V
according to (10/700 μs IEC 60950)		
between coil and contacts (Relay with 1 coil)	2500 V	2500 V
between adjacent contact sets	2500 V	2500 V
between open contacts	2000 V	2500 V
Insulation according to IEC / EN 60950		Basic insulation
Clearance		1.3 mm
Creepage distance		2.5 mm

High Frequency Data

Capacitance	
between coil and contacts	max. 2 pF
between adjacent contact sets	max. 1.5 pF
between open contacts	max. 1 pF
RF Characteristics	
Isolation at 100 MHz / 900 MHz	- 39.0 dB / - 20.7 dB
Insertion loss at 100 MHz / 900 MHz	- 0.02 dB / - 0.27 dB
V.S.W.R. at 100 MHz / 900 MHz	1.04 / 1.40

General Data

Operate time at U _{nom} typ. / max.	3 ms / 4 ms
Reset time (latching) at U _{nom} , typ. / max.	3 ms / 4 ms
Release time without diode in parallel (non-latching), typ. / max.	2 ms / 4 ms
Release time with diode in parallel (non-latching), typ. / max.	4 ms / 6 ms
Bounce time at closing contact, typ. / max.	1 ms / 3 ms
Maximum switching rate without load	50 operations/s
Ambient temperature	-40 °C ... +85 °C
Thermal resistance	< 125 K/W
Maximum permissible coil temperature	125 °C
Vibration resistance (function)	35 G
	10 to 1000 Hz
Shock resistance, half sinus, 11 ms	50 G (function)
	150 G (damage)
Degree of protection / Environmental protection	immersion cleanable, IP 67 / RT III
Needle flame test	application time 20 s, no burning < 15s
Mounting position	any
Processing information	Ultrasonic cleaning is not recommended
Weight (mass)	max. 2.8 g
Terminal surface	SnCu 0.7
Moisture sensitive level (JEDEC J-STD-020B) - SMD types	MSL 3
Resistance to soldering heat	265 °C / 10 s

All data refers to 23 °C unless otherwise specified.

P2 V23079 Relay

Recommended Soldering Conditions

Soldering conditions according IEC 60058-2-58 and IPC/JEDEC J-STD-020B

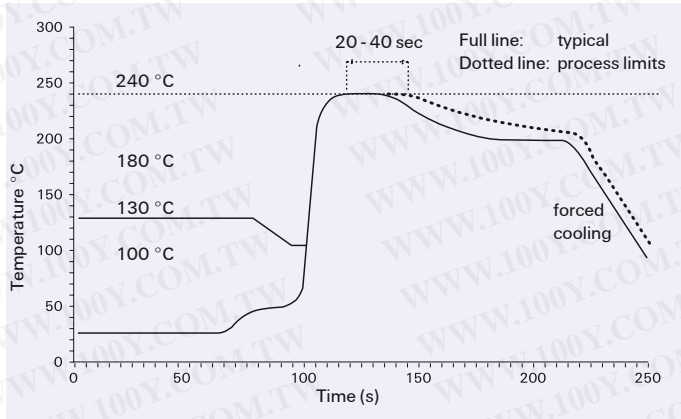

勝特力材料 886-3-5753170
 勝特力电子(上海) 86-21-34970699
 勝特力电子(深圳) 86-755-83298787
[Http://www.100y.com.tw](http://www.100y.com.tw)

Vapor Phase Soldering: Temperature/Time Profile (Lead and Housing Peak Temperature)

Recommended reflow soldering profile

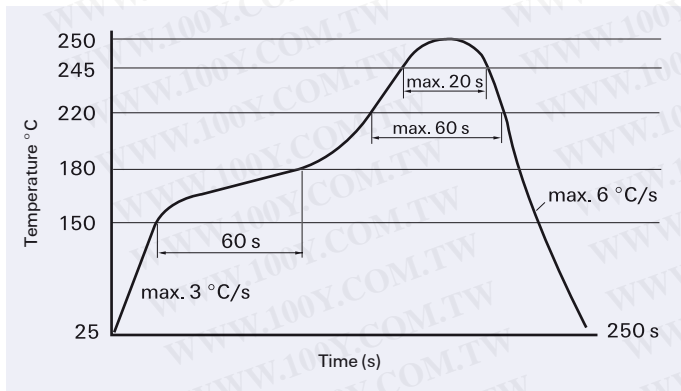

Infrared Soldering: Temperature/Time Profile (Lead and Housing Peak Temperature)

Resistance to soldering heat - Reflow profile

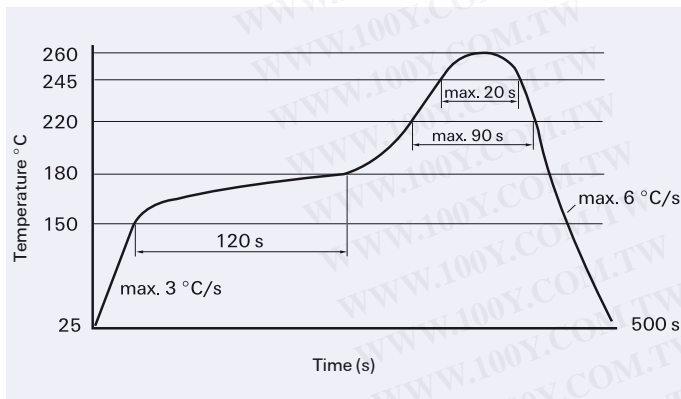

Infrared Soldering: Temperature/Time Profile (Lead and Housing Peak Temperature)

P2 V23079 Relay

Packing Dimensions in mm

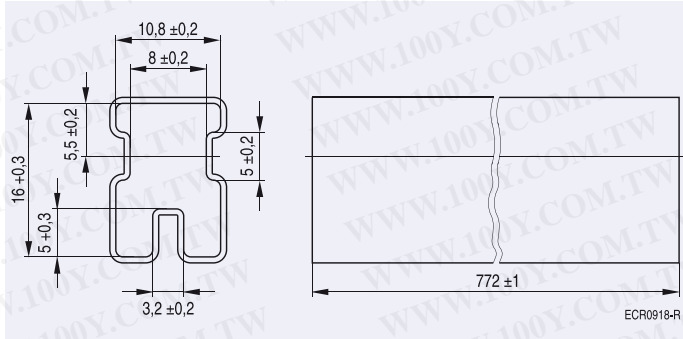

勝特力材料 886-3-5753170
 勝特力电子(上海) 86-21-34970699
 勝特力电子(深圳) 86-755-83298787
[Http://www.100y.com.tw](http://www.100y.com.tw)

Tube for THT version
 50 relays per tube
 2'000 relays per box

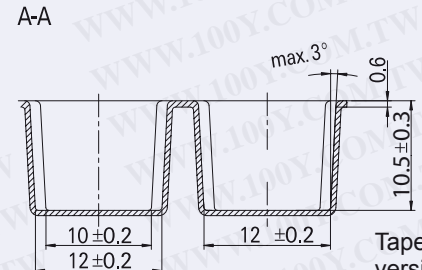
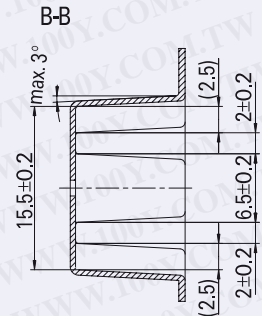
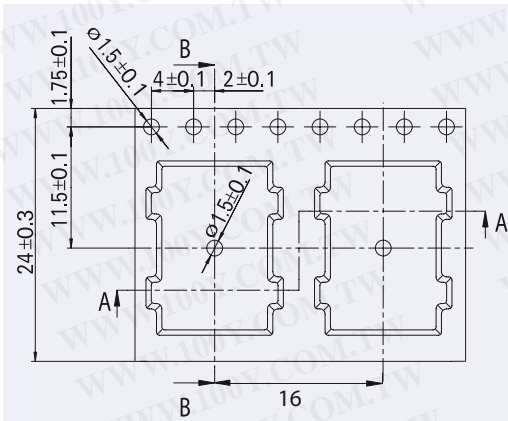

Tape and reel for SMT version
 with long terminals
 400 relays per reel
 2'000 relays per box

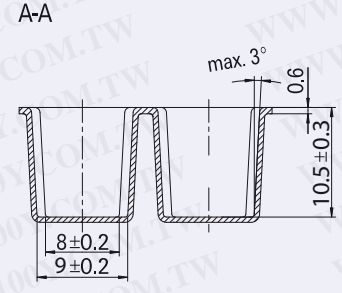
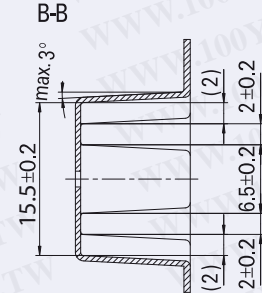
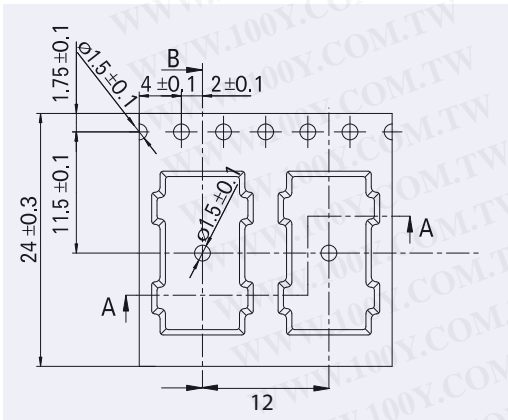

Tape and reel for SMT version
 with short terminals
 500 relays per reel
 2'500 relays per box

Reel dimension

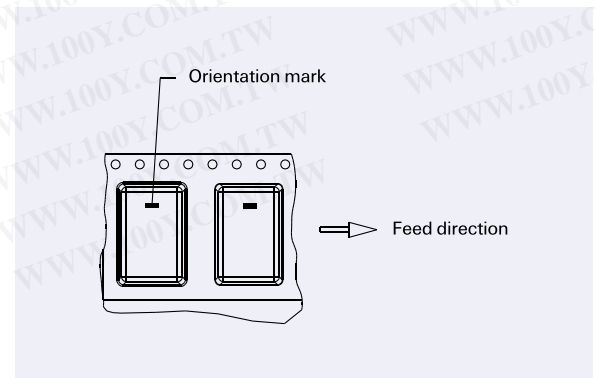
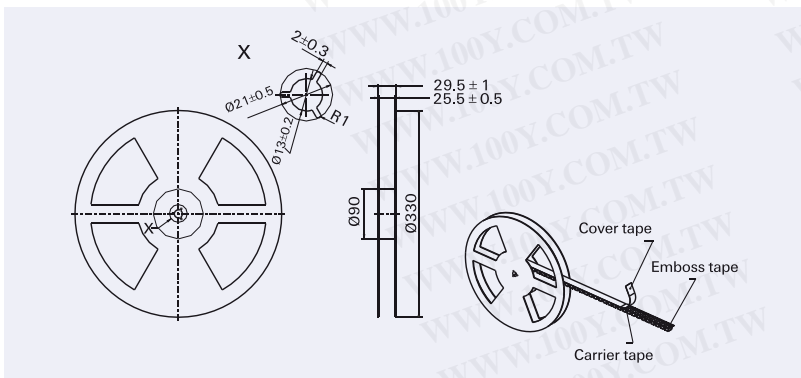

P2 V23079 Relay

IM Relays

4th generation slim line – low profile polarized 2 c/o telecom signal relay with bifurcated contacts, available as non latching or latching relay with 1 coil. Nominal voltage range from 1.5 ... 24 V, coil power consumption of 50 ... 200 mW, latching relays with 1 coil 100 mW. The IM relay is available as through hole and surface mount type (J-Legs and Gull Wings) and capable to switch loads up to 60 W/62,5 VA. It is currently the only 2 A rated 4G relay on the market. Dielectric strength fulfills the Telcordia requirements according GR 1089 (2,5 kV – 2 / 10 μ s) and FCC part 68 (1,5 kV – 10 / 160 μ s). The IM relay is tested according CECC/IECQ and certified in accordance with IEC/EN 60950 and UL 60950.

Dimensions approx. 10 x 6 mm board space and 5.65 mm height.

P2 Relays

3rd generation polarized 2 c/o telecom relay with bifurcated contacts, available as non latching or latching relay with 1 or 2 coils. Nominal voltage range from 3 ... 24 V, coil power consumption 140 mW, latching relays with 1 coil 70 mW. The P2 Relay is available as through hole or surface mount type and capable to switch currents up to 5 A. Dielectric strength fulfills the Telcordia requirements according GR 1089 (2,5 kV – 2 / 10 μ s) and FCC part 68 (1,5 kV – 10 / 160 μ s). The P2 relay is tested according CECC/IECQ and certified in accordance with IEC/EN 60950 and UL 60950. Dimensions approx. 15 x 7,5 mm board space and 10 mm height.

FX2 Relays

3rd generation polarized 2 c/o telecom relay with bifurcated contacts, available as non latching or latching relay with 1 coil. Nominal voltage range from 3 ... 48 V, coil power consumption of 80 ... 260 mW for the high sensitive version, 140... 300 mW for the standard version, latching relays with 1 coil 100 mW. The FX2 relay is available as through hole type and capable to switch loads up to 60 W/62,5 VA. Dielectric strength fulfills the Telcordia requirements according GR 1089 (2,5 kV – 2 / 10 μ s) and FCC part 68 (1,5 kV – 10 / 160 μ s). The FX2 relay is tested according CECC/IECQ and certified in accordance with IEC/EN 60950 and UL 60950. Dimensions approx. 15 x 7,5 mm board space and 10,7 mm height.

FT2 / FU2 Relays

3rd generation non polarized, non latching 2 c/o telecom relay with bifurcated contacts. Nominal voltage range from 3 ... 48 V, coil power consumption 200 ... 300 mW. Most sensitive 48 V relay. Available as through hole and surface mount type. Dielectric strength fulfills the Telcordia requirements according GR 1089 (2,5 kV – 2 / 10 μ s) and FCC part 68 (1,5 kV – 10 / 160 μ s). The FT2/FU2 relay is tested according CECC/IECQ and certified in accordance with IEC/EN 60950 and UL 60950. Dimensions approx. 15 x 7,5 mm board space and 10 mm height.

FP2 Relays

3rd generation polarized 2 c/o telecom relay with bifurcated contacts, available as non latching or latching relay with 1 or 2 coils. Nominal voltage range from 3 ... 48 V, coil power consumption of 80 ... 260 mW for the high sensitive version, 140... 300 mW for the standard version, latching relays with 1 coil 100 mW. The FP2 Relay is available as through hole type and capable to switch loads up to 60 W/62,5 VA. Dielectric strength fulfills FCC part 68 (1,5 kV – 10 / 160 μ s). The FP2 is tested according CECC/IECQ approved.

Dimensions approx. 14 x 9 mm board space and 5 mm height.

MT2

2nd generation non polarized, non latching 2 c/o telecom and signal relay with bifurcated contacts. Nominal voltage range from 3 ... 48 V, coil power consumption 150/200/300/400 and 550 mW. Dielectric strength fulfills the requirements according FCC part 68 (1,5 kV – 10 / 160 μ s).

Dimensions approx. 20 x 10 mm board space and 11 mm height.

D2n Relays

2nd generation non polarized 2 c/o relay for telecom and various other applications. Nominal voltage range from 3 ... 48 V, coil power consumption from 150 ... 500 mW. The D2n relay is capable to switch currents up to 3 A. Dielectric strength fulfills the requirements according FCC part 68 (1,5 kV – 10 / 160 μ s). Dimensions approx. 20 x10 mm board space and 11 mm height.

P1 Relays

Extremely sensitive, polarized 1 c/o relay with bifurcated contacts for a wide range of applications, available as non latching or latching relay with 1 or 2 coils. Nominal voltage range from 3 ... 24 V, coil power consumption 65 mW, latching relays with 1 coil 30 mW. The P1 relay is available as through hole or surface mount type and capable to switch currents up to 1 A. Dielectric strength fulfills the requirements according FCC part 68 (1,5 kV – 10 / 160 μ s). Dimensions approx. 13 x 7,6 mm board space and 7 mm height for THT or 8 mm height for SMT version.

W11 Relays

Low cost, non polarized 1 c/o relay for various applications. Nominal voltage range from 3 ... 24 V, coil power consumption 450 mW, sensitive versions 200 mW. The W11 relay is capable to switch currents up to 3 A. Dielectric strength 1000 Vrms. Dimensions approx. 15,6 x 10,6 mm board space and 11,5 mm height.

Reed Relays

High sensitive, non polarized relay for telecom and various other applications, available with 1 n/o, 2 n/o or 1c/o contacts. Nominal voltage range from 5 ... 24 V, coil power consumption 50...280 mW for 1 n/o and 125 ... 280 mW for 2 n/o or 1 c/o versions. Reedrelays are available in DIP or SIL housing and capable to switch currents up to 0,5 A. Integrated diode and/or electrostatic shield optional. Dielectric strength 1500 Vdc. Dimensions approx. 19,3 x 7 mm board space and 5 ... 7,5 mm height for DIP or 19,8 x 5 mm board space and 7,8 mm height for SIL version.

Cradle Relays

Extremely reliable and mature relay family of 1st generation for various signal switching applications. Available as non polarized, polarized / latching and relay with AC coil. The benefit is the possibility of combining various contact sets from 1 up to 6 poles, single and bifurcated contacts, different contact materials with a coil voltage range from 1,5 Vdc to 220 Vac. Cradle relays are available as dust protected and hermetically sealed versions, with plug in or solder terminals and are capable to switch currents up to 5 A. Forcibly guided (linked) contact sets optional. Dielectric strength 500 Vrms. Dimensions from approx. 19 x 24 to 19x35 mm board space and 30 mm height.

Other Relays

We offer a variety of different relay families for maintenance and replacement purposes. These relays are up to 60 years old now, such as Card Relay SN (V23030 series), Small General Purpose Relay (V23006 series), Small Polarized Relay (V23063 ... V23067 and V23163 ... V23167 series). Accessories like sockets, hold down springs, etc. optional.

High Frequency Relays

HF3 / HF3S / HF6 series RF relays offering excellent RF characteristics in a small package. All HF series relays are suitable for SMD soldering processes. Available as non latching or latching versions with 1 or 2 coils and a nominal coil voltage range from 3 ... 24 V, a coil power consumption of 140 mW or 70 mW (single coil latching types).

HF3: Low cost RF relay suitable up to 3 GHz. Impedance 50 and 75 Ohm. 50 W hot switching and 50 W RF power carry capability. Dimensions 14.6 x 7.3 x 10.3 mm.

HF3S: High performance, high power RF relay suitable up to 3 GHz, 50 W hot switching and 150 W RF power carry capability. Dimensions 15 x 7.6 x 10.6 mm.

HF6: High performance, high power RF relay suitable up to 6 GHz, 50 W hot switching and 50 W RF power carry capability. Dimensions 15 x 7.6 x 10.6 mm.