

# HRS2(H) Relay

## 1.COIL DATA

1-1.Nominal Voltage	3 VDC to 24 VDC
1-2.Coil Resistance	Refer to Table 1
1-3.Operate Voltage	Refer to Table 1
1-4.Release Voltage	Refer to Table 1
1-5.Nominal Power Consumption	150 to 360 mW

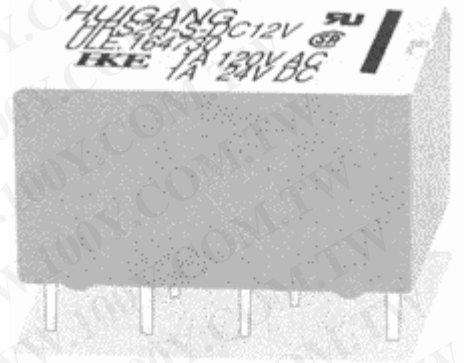

HRS2(H) Relay

## 2.CONTACT DATA

2-1.Contact Arrangement	2 Form C
2-2.Contact Material	AuAg
2-3.Contact Rating	1A 24 VDC / 120VAC
2-4.Max. Switching Voltage	60 VDC / 120 VAC
2-5.Max. Switching Current	2A
2-6.Max. Switching Power	60 VA , 24W
2-7.Contact Resistance ( Initial )	100 mΩ at 6 VDC 1A
2-8.Life Expectancy	Electrical 100,000 operations at nominal load Mechanical 10,000,000 operations

## 3.GENERAL DATA

3-1.Insulation Resistance	Min.100MΩ at 500 VDC
3-2.Dielectric Strength	1,000VAC , 1min between open contact 1,500VAC , 1min between contact and coil
3-3.Surge Strength	2,000 VAC ( 20 ㎁s )
3-4.Operate Time	Max. 6ms
3-5.Release Time	Max. 4ms
3-6.Temperature Range	-30 to +60 ㎁
3-7.Shock Resistance	15G
3-8.Vibration Resistance	10 - 55 Hz , Amplitude 1.5mm
3-9.Weight	5 gr.
3-10.Safety Standard	UL NO. E164730 CSA NO. LR109368

勝特力材料 886-3-5753170  
勝特力电子(上海) 86-21-34970699  
勝特力电子(深圳) 86-755-83298787  
[Http://www.100y.com.tw](http://www.100y.com.tw)

勝特力材料 886-3-5753170  
 勝特力电子(上海) 86-21-34970699  
 勝特力电子(深圳) 86-755-83298787  
 Http://www.100y.com.tw

#### 4.DIMENSIONS ( in mm )

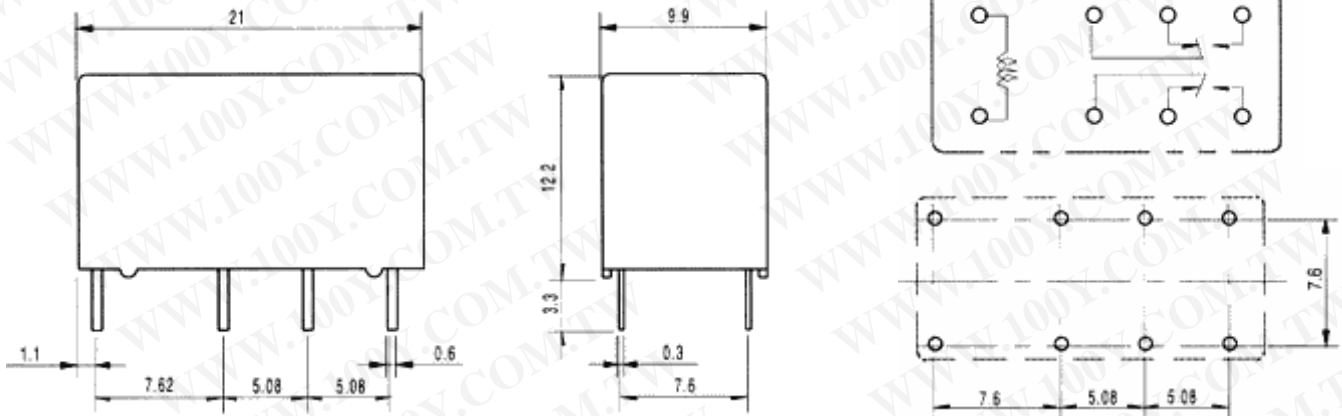

#### 5.ORDERING CODE

<b>HRS2</b>	<b>H-</b>	<b>S</b>	<b>DC 3V</b>	ꠁꠁꠁ	
				ꠁꠁ	NOMINAL VOLTAGE: DC3V , DC5V , DC6V , DC9V , DC12V , DC24V
				ꠁꠁS	ENCLOSURE S ---- WASHABLE
				ꠁꠁ	COIL ꠁꠁNIL ---- STANDARD TYPE H ----- HIGH SENSITIVE TYPE ( 150 mW , 200 mW )
				ꠁꠁ	TYPE

#### 6.COIL DATA CHART

ORDERING CODE	COIL NOMINAL VDC	COIL RESISTANCE $\Omega$ $\pm 10\%$	OPERATE VOLTAGE VDC	RELEASE VOLTAGE VDC	COIL NOMINAL mW
HRS2-S DC3V	3	25	2.25	0.30	360
HRS2-S DC5V	5	70	3.75	0.50	
HRS2-S DC6V	6	100	4.50	0.60	
HRS2-S DC9V	9	220	6.75	0.90	
HRS2-S DC12V	12	400	9.00	1.20	
HRS2-S DC24V	24	1600	18.00	2.40	
HRS2H-S DC3V	3	45	2.25	0.30	200
HRS2H-S DC5V	5	120	3.75	0.50	
HRS2H-S DC6V	6	180	4.50	0.60	
HRS2H-S DC9V	9	400	6.75	0.90	
HRS2H-S DC12V	12	700	9.00	1.20	
HRS2H-S DC24V	24	2800	18.00	2.40	

Table 1

## 7.HRS2(H) CHARACTERISTIC DATA

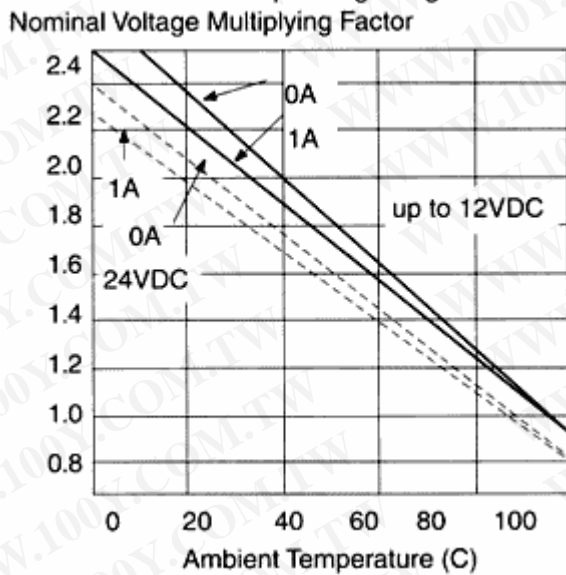
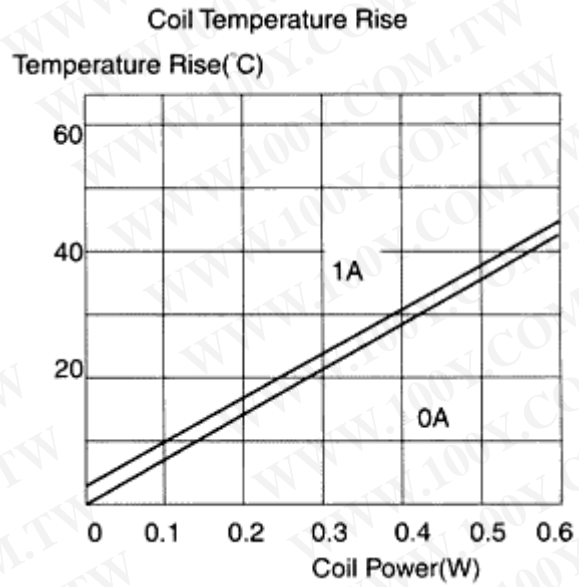
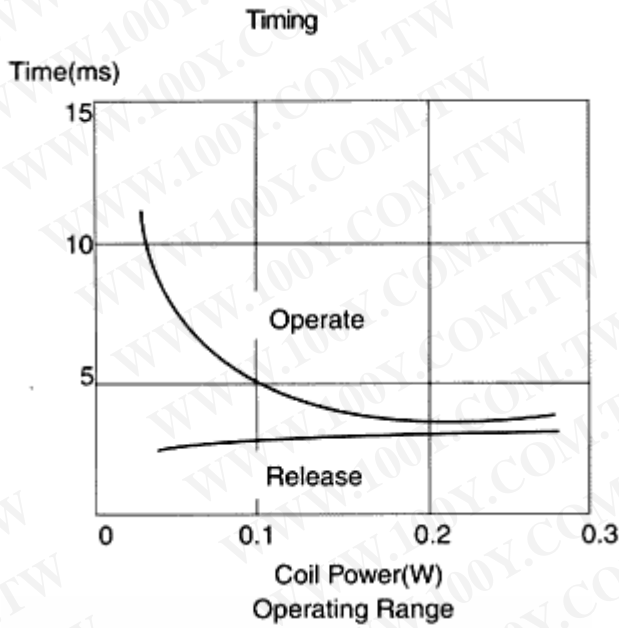

勝特力材料 886-3-5753170  
 勝特力电子(上海) 86-21-34970699  
 勝特力电子(深圳) 86-755-83298787  
[Http://www.100y.com.tw](http://www.100y.com.tw)

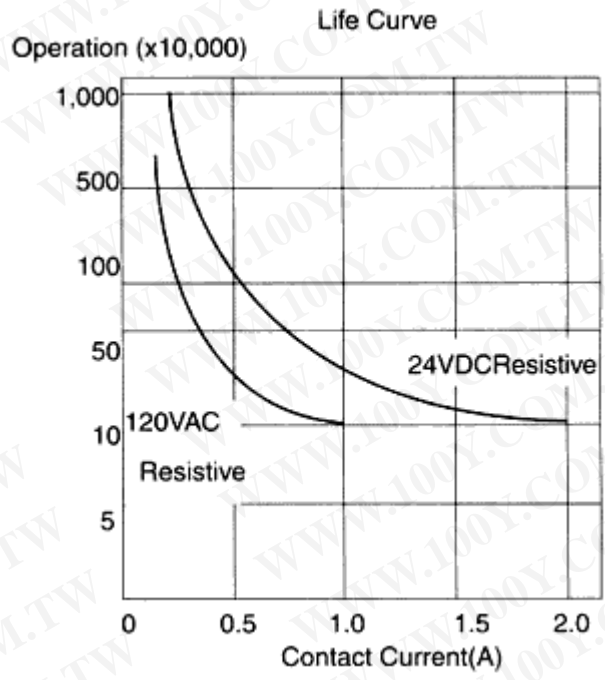
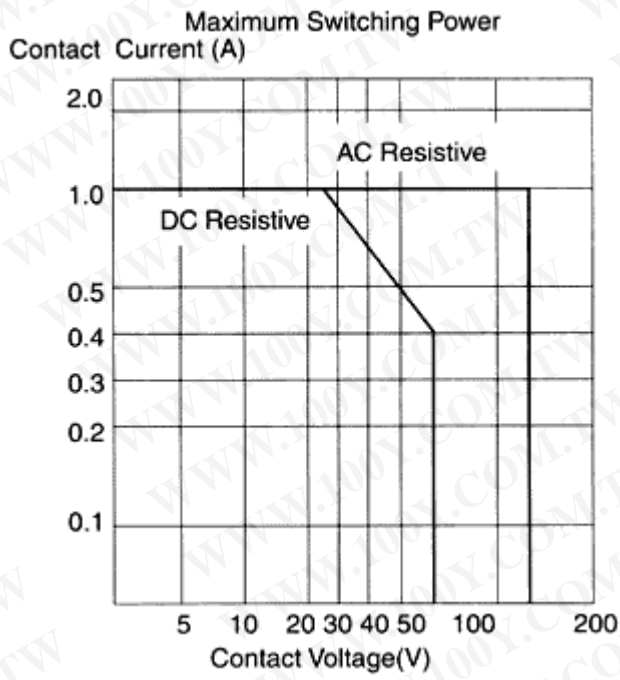

勝特力材料 886-3-5753170  
 勝特力电子(上海) 86-21-34970699  
 勝特力电子(深圳) 86-755-83298787  
[Http://www.100y.com.tw](http://www.100y.com.tw)