

勝特力材料 886-3-5753170
 勝特力电子(上海) 86-21-34970699
 勝特力电子(深圳) 86-755-83298787
 Http://www.100y.com.tw

UL Recognized
 File No. E43641



LISTED 367G
 IND. CONT. EQ.



COMPLIES WITH REQUIREMENTS OF

- * IEC STANDARDS 947-4-1 AND 947-5-1 LOW VOLTAGE DIRECTIVE
- * IEC = INTERNATIONAL ELECTROTECHNICAL COMMISSION
- * CE TESTING AND EVALUATION PERFORMED BY THE UNDERWRITERS LABORATORIES AS A THIRD PARTY PARTICIPANT

FEATURES

40 AMP POWER RELAY

RATINGS TO 50 AMPS WITH WIRE PRESSURE CONNECTOR

METAL ENCLOSURE AVAILABLE

OPTIONAL 10 AMP SPDT AUXILIARY SWITCH

MANUFACTURED
 UNDER
 ISO 9002
 & QS 9000

CONTACT LOAD RATINGS TABLE

	SINGLE MAKE/BREAK CONTACTS	DOUBLE MAKE/BREAK CONTACTS
UP TO 300 VAC 50/60HZ	40 A, RESISTIVE (AC1)	40 A, RESISTIVE (AC1)
480 VAC 50/60HZ	5 A, RESISTIVE (AC1)	12 A, RESISTIVE (AC1)
600 VAC 50/60HZ	5 A, RESISTIVE (AC1)	10 A, RESISTIVE (AC1)
28 VDC	40 A, RESISTIVE (DC1)	40 A, RESISTIVE (DC1)
MOTOR LOAD, 120 - 600 VAC 50/60HZ	1 1/2 HP	2 HP
TUNGSTEN, 120 VAC 50/60HZ	15 A	15 A
120 - 600 VAC 50/60HZ	960 VA	1152 VA
NEMA PILOT DUTY 50/60HZ	A 600	A 600
SHORT CIRCUIT	5000 A	5000 A
DOUBLE- POLE WITH BOTH SIDES SWITCHING THE LOAD		
200 - 600 VAC 50/60HZ	2 HP	
200 - 600 VAC 50/60HZ	1152 VA	
ADDITIONAL DC RATING WITH MAGNETIC BLOWOUT		
110 VDC	10 A	20 A
144 VDC		15 A
220 VDC	4 A	8 A
325 VDC	2 A	4 A
500 VDC		2 A
AUXILIARY SWITCH		
UP TO 240 VAC 50/60HZ	10 A (AC1)	10 A (AC1)
MOTOR LOAD, 120- 240 VAC 50/60HZ	1/4 HP	1/4 HP
PILOT DUTY, 120- 240 VAC 50/60HZ	278 VA	278 VA
125 VDC	0.4 A (DC1)	0.4 A (DC1)
250 VDC	0.2 A (DC1)	0.2 A (DC1)
TUNGSTEN, 120 VAC 50/60 HZ	3 A	3 A
WITH WIRE PRESSURE CONNECTORS		
UP TO 300 VAC 50/60 HZ		50 A, RESISTIVE (AC1)
28 VDC		50 A, RESISTIVE (DC1)

GENERAL SPECIFICATIONS (@ 25°C)

	UNITS	
COIL		
Pull-in Voltage AC (50/60 Hz):≤	% of nominal	85
Pull-in Voltage DC:≤	% of nominal	80
Dropout Voltage AC (50/60 Hz):≥	% of nominal	10
Dropout Voltage DC:≥	% of nominal	10
Maximum Voltage:	% of nominal	110
Resistance Tolerance:	% ±	10
Coil Power AC (50/60 Hz):	VA	10
Coil Power DC:	W	2
Insulation System		
Per UL Standard 1446:		Class B (130 °C)
Duty:		Continuous
CONTACTS		
Material:		Silver alloy, gold flashed
Minimum Recommended Load:	amps	1 @ 5 VDC or 5 W
TIMING		
Operate Time @ Nominal voltage:	ms	40
Release Time @ Nominal voltage:	ms	30
DIELECTRIC STRENGTH		
Coil to Contacts:	V rms	2200
Across Open Contacts:	V rms	1500
Pole to Pole:	V rms	1500
Contacts to Frame:	V rms	Not Applicable
Insulation Resistance:	megohms minimum@VDC	1000 @ 500
TEMPERATURE		
Operating, AC Lower:	°C	-40
Operating, AC Upper:	°C	+50
Operating, DC Lower:	°C	-40
Operating, DC Upper:	°C	+60
Storage, Lower:	°C	-55
Storage, Upper:	°C	+100
LIFE EXPECTANCY		
Electrical @ Rated Load (AC1):	operations	100,000
Mechanical @ no Load :	operations	1,000,000
MISCELLANEOUS		
Operating Position:		Any
Coil Terminals:		#6-32 combination head screws
Contact Terminals:		#8-32 combination head screws
Weight:	grams	227 to 312

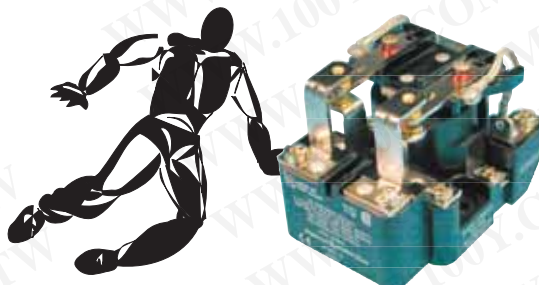



UP TO 50 AMPS

OUTLINE DIMENSIONS
 DIMENSIONS SHOWN IN INCHES & (MILLIMETERS).

199 SPDT
 40 AMP, 1-1/2 Hp

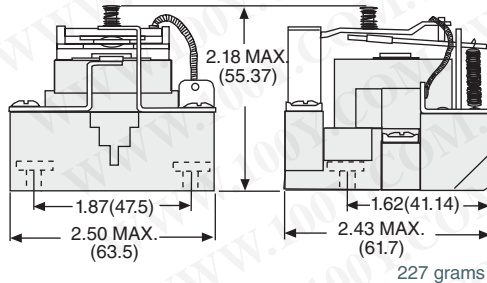

199 DPDT
 40 AMP, 1-1/2 Hp PER POLE
 2 Hp - 2 POLE SWITCHING

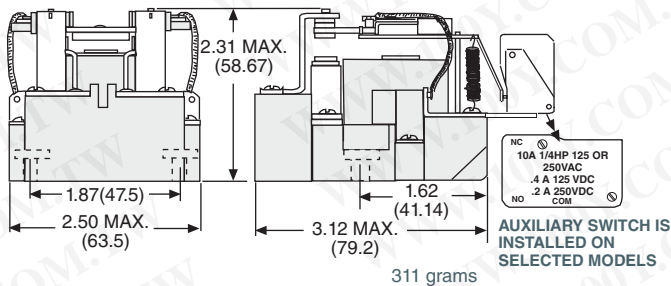

199 DPST-NO
 40 AMP, 1-1/2 Hp PER POLE
 2 Hp - 2 POLE SWITCHING

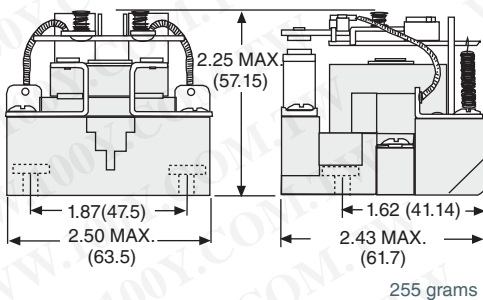

199 SPST-NO-DM
 40 AMP, 2 Hp

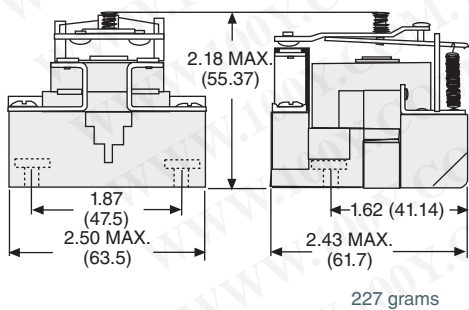

199DB SPST-NO-DM
 WITH MAGNETIC BLOWOUT FOR DC
 ARC QUENCHING 20 AMP, 110 VDC

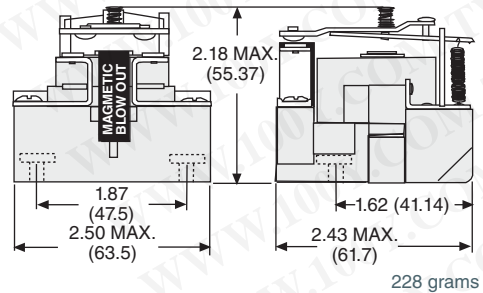

199B DPDT
 WITH MAGNETIC BLOWOUT FOR DC
 ARC QUENCHING 10 AMP, 110 VDC PER POLE

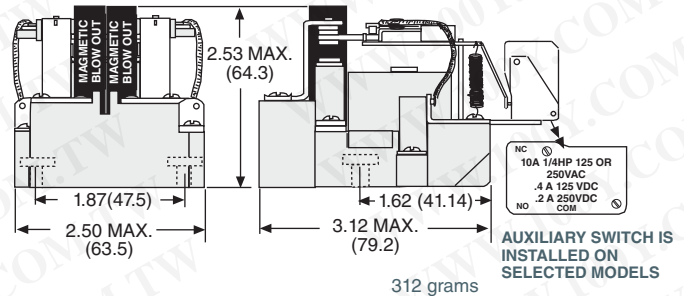

199DE SPST-NO-DM
 WITH BOX TERMINALS.
 50 AMP, 2 Hp

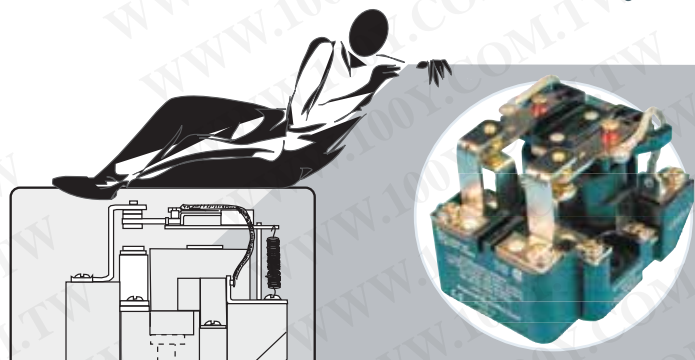
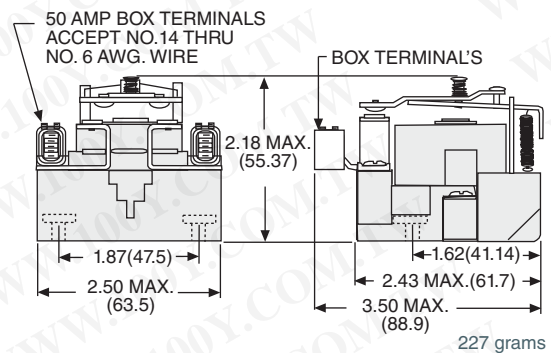

199 OPEN STYLE POWER RELAYS



UP TO 50 AMPS

WIRING DIAGRAM
(VIEWED FROM TOP)



199 DPST-NO
 40 AMP, 1-1/2 Hp PER POLE
 2 Hp - 2 POLE SWITCHING

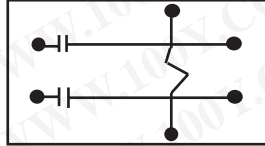

199 DPDT
 40 AMP, 1-1/2 Hp PER POLE, 2 Hp-2 POLE SWITCHING

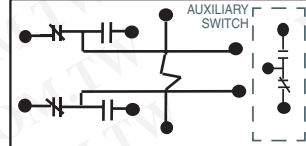

199 SPDT
 40 AMP, 1-1/2 Hp

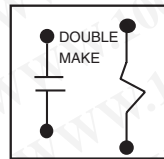
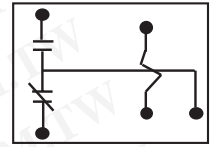

199DB SPST-NO-DM
 WITH MAGNETIC BLOWOUT FOR DC ARC
 QUENCHING 20 AMP, 110 VDC

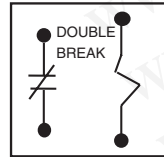

199 SPST-NC-DB
 40 AMP, 2 Hp

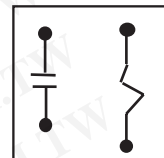

199 SPST-NO-DM
 40 AMP, 2 Hp

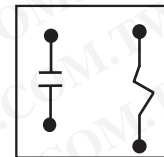

199DE SPST-NO-DM
 WITH BOX TERMINALS.
 50 AMP, 2 Hp

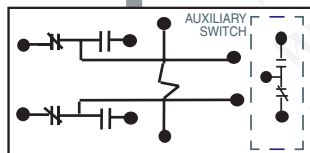
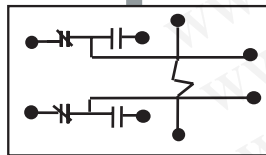

199B DPDT
 WITH MAGNETIC BLOWOUT FOR
 DC ARC QUENCHING

* REFERENCE DOUBLE MAKE/
 BREAK CONTACT RATINGS

STANDARD PART NUMBERS	CONTACT CONFIGURATION	COIL MEASURED @ 25 °C	
		NOMINAL INPUT VOLTAGE	NOMINAL RESISTANCE (OHMS)
AC OPERATED			
W199AX-4	SPDT	120 VAC 50/60 Hz	290 Ω
W199AX-13	DPDT	24 VAC 50/60 Hz	12 Ω
W199AX-14	DPDT	120 VAC 50/60 Hz	290 Ω
W199AX-15	DPDT	240 VAC 50/60 Hz	1200 Ω
W199AX-8	DPST-NO	24 VAC 50/60 Hz	12 Ω
W199AX-9	DPST-NO	120 VAC 50/60 Hz	290 Ω
W199AX-10	DPST-NO	240 VAC 50/60 Hz	1200 Ω
W199ADX-4	*SPST-NO-DM	120 VAC 50/60 Hz	290 Ω
W199ADX-5	*SPST-NO-DM	240 VAC 50/60 Hz	1200 Ω
W199ADBX-4	*SPST-NO-DM (magnetic blowout)	120 VAC 50/60 Hz	290 Ω
W199ABX-14	DPDT (magnetic blowout)	120 VAC 50/60 Hz	290 Ω
AC OPERATED WITH SPDT AUXILIARY			
W199ABMX-7	DPDT (magnetic blowout)	120 VAC 50/60 Hz	290 Ω
W199AMX-64	DPDT	120 VAC 50/60 Hz	290 Ω
AC OPERATED WITH BOX TERMINALS			
W199ADEX-4	*SPST-NO-DM	120 VAC 50/60 Hz	290 Ω
DC OPERATED			
W199X-2	SPDT	12 VDC	70 Ω
W199X-3	SPDT	24 VDC	290 Ω
W199X-11	DPDT	6 VDC	18 Ω
W199X-12	DPDT	12 VDC	70 Ω
W199X-13	DPDT	24 VDC	290 Ω
W199X-14	DPDT	110 VDC	6000 Ω
W199X-7	DPST-NO	12 VDC	70 Ω
W199X-8	DPST-NO	24 VDC	290 Ω
W199DYX-2	*SPST-NC-DB	12 VDC	70 Ω
W199DX-2	*SPST-NO-DM	12 VDC	70 Ω
W199DX-3	*SPST-NO-DM	24 VDC	290 Ω
W199DBX-3	*SPST-NO-DM (magnetic blowout)	24 VDC	290 Ω
W199DBX-6	*SPST-NO-DM (magnetic blowout)	48 VDC	1200 Ω
W199BX-13	DPDT (magnetic blowout)	24 VDC	290 Ω
W199BX-14	DPDT (magnetic blowout)	110 VDC	6000 Ω
DC OPERATED WITH SPDT AUXILIARY			
W199BMX-13	DPDT (magnetic blowout)	24 VDC	290 Ω
W199MX-51	DPDT	24 VDC	290 Ω
DC OPERATED WITH BOX TERMINALS			
W199DEX-3	*SPST-NO-DM	24 VDC	290 Ω

OTHER COIL VOLTAGES ARE AVAILABLE ON SPECIAL ORDER.
 CONTACT FACTORY FOR DETAILS