

**Impulse Withstand Voltage as High as 10 kV with 4kV Dielectric Strength: Ideal for Power Supply Switching**

- Creepage distance of 8 mm min.
- Dielectric strength of 4,000 VAC min.
- SPST-NO types conform to TV-8 rating.
- DPST-NO types conform to TV-5 rating.
- International 2.54mm terminal pitch.



**Ordering Information**

Contacts		SPST-NO	DPST-NO
Mounting style	Terminals		
General purpose	PCB (straight)	G4W-1112P-US-TV8	G4W-2212P-US-TV5
Upper mounting	Solder	G4W-11123A-US-TV8	G4W-22123A-US-TV5
	Quick-connect	G4W-11123T-US-TV8	G4W-22123T-US-TV5

**Note:** When ordering, add the rated coil voltage to the model number.  
 Example: G4W-11123A-US-TV8 12 VDC

Rated coil voltage

**Model Number Legend**

G4W -      -  -   VDC  
 1 2 3 4 5 6 7 8 9

- |   |  |   |
|---|--|---|
| <p><b>1. Contact Form</b><br/>                 11: SPST-NO<br/>                 22: DPST-NO</p> <p><b>2. Contact Type</b><br/>                 1: Single button</p> <p><b>3. Enclosure Ratings</b><br/>                 2: Unsealed</p> | <p><b>4. Mounting Style</b><br/>                 None: Standard<br/>                 3: Upper mounting bracket</p> <p><b>5. Terminals</b><br/>                 P: Straight PCB<br/>                 A: Solder<br/>                 T: Quick connect</p> <p><b>6. Approved Standards</b><br/>                 US: UL, CSA certified</p> | <p><b>7. TV Ratings</b><br/>                 TV5: TV-5<br/>                 TV8: TV-8</p> <p><b>8. Special Function</b><br/>                 None: General-purpose<br/>                 Z: Full-wave rectifier</p> <p><b>9. Rated Coil Voltage</b><br/>                 12, 24, 100 VDC</p> |
|---|--|---|

勝特力材料 886-3-5753170  
 胜特力电子(上海) 86-21-34970699  
 胜特力电子(深圳) 86-755-83298787  
 Http://www.100y.com.tw

## Specifications

## ■ Coil Ratings

Single-side Stable Type

Rated voltage	12 VDC	24 VDC	100 VDC
Rated current	66.7 mA	33.3 mA	8 mA
Coil resistance	180 Ω	720 Ω	12,500 Ω
Coil inductance	Armature OFF 0.93	3.7	61.8
(H) (ref. value)	Armature ON 1.65	6.4	106
Must operate voltage	80% max. of rated voltage		
Must release voltage	10% min. of rated voltage		
Max. voltage	130% of rated voltage (at 23°C)		
Power consumption	Approx. 800 mW		

Note: 1. The rated current and coil resistance are measured at a coil temperature of 23°C with a tolerance of ±15%.

2. Operating characteristics are measured at a coil temperature of 23°C.

## ■ Contact Ratings

Item	SPST-NO		DPST-NO	
	Resistive load ( $\cos\phi = 1$ )	Inductive load ( $\cos\phi = 0.4$ ; L/R = 7 ms)	Resistive load ( $\cos\phi = 1$ )	Inductive load ( $\cos\phi = 0.4$ ; L/R = 7 ms)
Rated load	15A at 250 VAC; 15A at 24 VDC	10A at 250 VAC; 7.5A at 24 VDC	10A at 250 VAC; 10A at 24 VDC;	7.5A at 250 VAC; 5A at 24 VDC
Contact material	AgCdO (Cd free planned 1 Apr 05)			
Rated carry current	15A		10A	
Max. switching voltage	250 VAC, 125 VDC			
Max. switching current	15A		10A	
Max. switching power	3,750 VA, 375 W	2,500 VA, 255 W	2,500 VA, 240 W	1,850 VA, 120 W
Failure rate (reference value)	100 mA at 5 VDC			

## ■ Characteristics

Contact resistance	30 mΩ max.
Operate time	20 ms max. (mean value: approx. 13 ms)
Release time	5 ms max. (mean value: approx. 2.5 ms)
Bounce time	Operate: approx. 3 ms
Max. Operating Frequency	Mechanical: 18,000 operations/hr Electrical: 1,800 operations/hr (under rated load)
Insulation resistance	100 MΩ max. (at 500 VDC)
Dielectric strength	4,000 VAC, 50/60 Hz for 1 min between coil and contacts 2,000 VAC, 50/60 Hz for 1 min between contacts of different polarities (DPST-NO) 1,500 VAC, 50/60 Hz for 1 min between contacts of same polarity
Impulse withstand voltage	10,000 V (1.2 x 50 μs) between coil and contacts
Vibration resistance	Destruction: 10 to 55 to 10 Hz, 0.75mm single amplitude (1.5mm double amplitude) Malfunction: 10 to 55 to 10 Hz, 0.75mm single amplitude (1.5mm double amplitude)
Shock resistance	Destruction: 1,000 m/s <sup>2</sup> Malfunction: 150 m/s <sup>2</sup>
Endurance	Mechanical: 5,000,000 operations min. (at 18,000 operations/hr) Electrical: 100,000 operations min. (at 1,800 operations/hr)
Ambient temperature	Operating: -25°C to 55°C (with no icing)
Ambient humidity	Operating: 5% to 85% RH
Weight	Approx. 29 g

勝特力材料 886-3-5753170  
 胜特力电子(上海) 86-21-34970699  
 胜特力电子(深圳) 86-755-83298787  
[Http://www.100y.com.tw](http://www.100y.com.tw)

## ■ Approved Standards

UL508 (File No. E41643)/CSA C22.2 No.14 (File No.LR31928)

Model	Contact Form	Coil ratings	Contact ratings
G4W-1112P-US-TV8 G4W-11123A-US-TV8 G4W-11123T-US-TV8	SPST-NO	6 to 120 VDC	15 A, 250 VAC (general use) 15 A, 24 VDC TV-8 1/2 hp, 125 VAC 1 hp, 250 VAC 3/4 hp, 240 VAC
G4W-2212P-US-TV5 G4W-22123A-US-TV5 G4W-22123T-US-TV5	DPST-NO		15 A, 250 VAC (general use) 10 A, 250 VAC (general use) 15 A, 24 VDC TV-5 1/2 hp, 250 VAC 1/3 hp, 125/250 VAC

## SEMKO (File No. 9346122, 9223128)

Contact form	Coil ratings	Contact ratings
SPST-NO	6-100 VDC	15/120 A, 250 VAC
DPST	6-120 VDC	10/80 A, 250 VAC

## EN 61810-1 (VDE0435 (File No. 1906, No. 1907)

Contact form	Coil ratings	Contact ratings
SPST-NO	6, 12, 24, 48, 100 VDC	15 A, 250 VAC (cos $\phi$ = 1.0) 10 A, 250 VAC (cos $\phi$ = 0.4) 15 A, 24 VDC (0 ms) 7.5 A, 24 VDC (40 ms)
DPST-NO		10 A, 250 VAC (cos $\phi$ = 1.0) 7.5 A, 250 VAC (cos $\phi$ = 0.4) 10 A, 24 VDC (0 ms) 5 A, 24 VDC (40 ms)

勝特力材料 886-3-5753170

胜特力电子(上海) 86-21-34970699

胜特力电子(深圳) 86-755-83298787

Http://www.100y.com.tw

Engineering Data

Maximum Switching Power

G4W-1112P-US-TV8/-11123A-US-TV8/-11123T-US-TV8

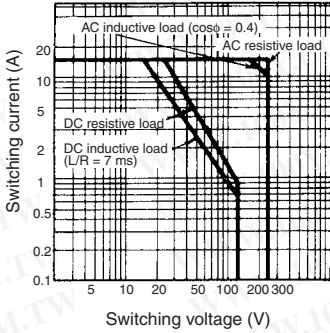

G4W-2212P-US-TV5/-22123A-US-TV5/-22123T-US-TV5

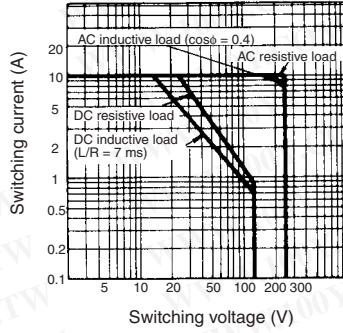

Endurance

G4W-1112P-US-TV8/-11123A-US-TV8/-11123T-US-TV8

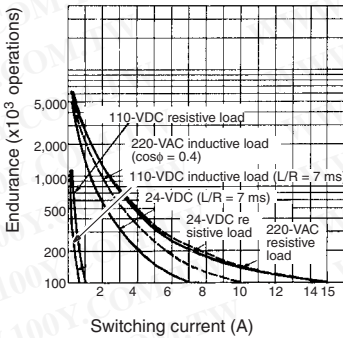

G4W-2212P-US-TV5/-22123A-US-TV5/-22123T-US-TV5

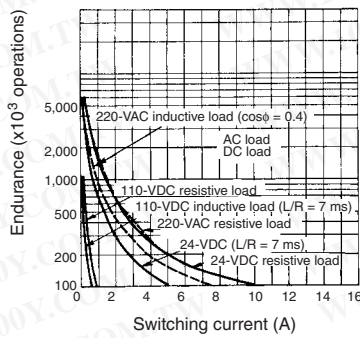

Ambient Temperature vs. Maximum Coil Voltage

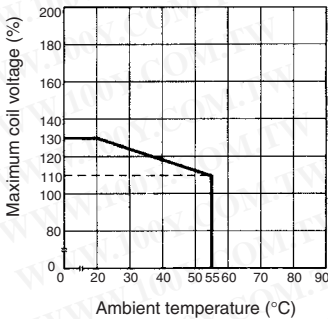

Note: The maximum coil voltage refers to the maximum value in a varying range of operating power voltage, not a continuous voltage.

勝特力材料 886-3-5753170  
 勝特力电子(上海) 86-21-34970699  
 勝特力电子(深圳) 86-755-83298787  
[Http://www.100y.com.tw](http://www.100y.com.tw)

Dimensions

G4W-□12P-US-TV

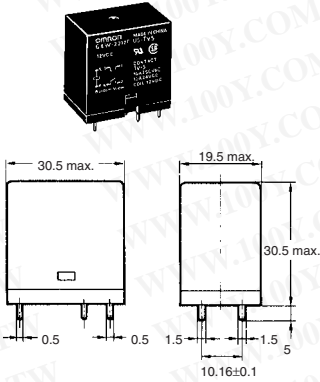

Mounting Holes (Bottom View)  
G4W-1112P-US-TV-8

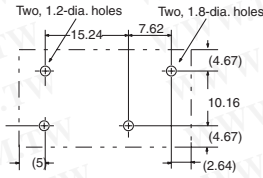

Terminal Arrangement/Internal Connections (Bottom View)

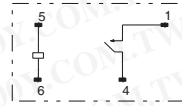

G4W-2212P-US-TV-5

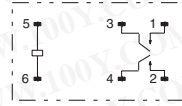
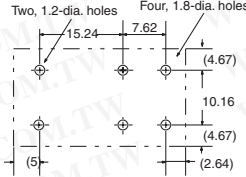

G4W-□123A-US-TV

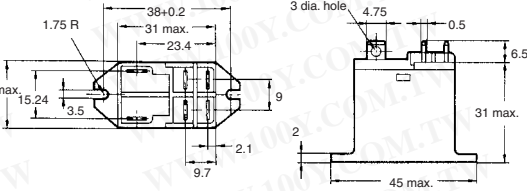

Terminal Arrangement/Internal Connections (Bottom View)  
G4W-11123A-US-TV-8



G4W-11123T-US-TV-8



G4W-□123T-US-TV

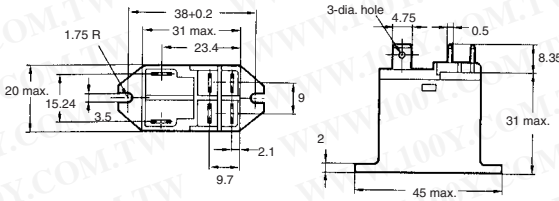
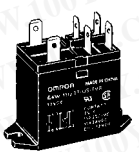

G4W-22123A-US-TV5  
G4W-22123T-US-TV5



Mounting Holes (Bottom View)  
Tolerance: ±0.2

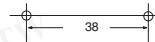

勝特力材料 886-3-5753170  
 勝特力电子(上海) 86-21-34970699  
 勝特力电子(深圳) 86-755-83298787  
[Http://www.100y.com.tw](http://www.100y.com.tw)

Complete "Terms and Conditions of Sale" for product purchase and use are on Omron's website at [www.omron.com/oei](http://www.omron.com/oei) – under the "About Us" tab, in the Legal Matters section.

**ALL DIMENSIONS SHOWN ARE IN MILLIMETERS.**

To convert millimeters into inches, multiply by 0.03937. To convert grams into ounces, multiply by 0.03527.



**OMRON ELECTRONIC COMPONENTS LLC**

55 E. Commerce Drive, Suite B  
Schaumburg, IL 60173

**847-882-2288**

**OMRON CANADA, INC.**

885 Milner Avenue  
Toronto, Ontario M1B 5V8

**416-286-6465**

**OMRON ON-LINE**

Global - <http://www.omron.com>  
USA - <http://www.omron.com/oei>  
Canada - <http://www.omron.ca>