

## MOS FET Relays

### G3VM-41HR

**Low 30-mΩ ON Resistance.**  
**Higher power, 2.5-A switching with a 40-V load voltage, SOP package.**

- Continuous load current of 2.5 A (connection C = 5 A).
- Dielectric strength of 1,500 Vrms between I/O.

**RoHS compliant**

⚠ Refer to "Common Precautions".

### Application Examples

- Broadband systems
- Measurement devices
- Data loggers
- Industrial equipment

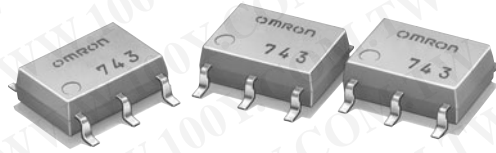

**NEW**

**Note:** The actual product is marked differently from the image shown here.

### List of Models

Contact form	Terminals	Load voltage (peak value) (See note.)	Model	Number per stick	Number per tape
SPST-NO	Surface-mounting terminals	40 V	G3VM-41HR	75	---
			G3VM-41HR(TR)	---	2,500

**Note:** The AC peak and DC value is given for the load voltage.

### Dimensions

**Note:** All units are in millimeters unless otherwise indicated.

**G3VM-41HR**

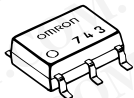

**Note:** The actual product is marked differently from the image shown here.

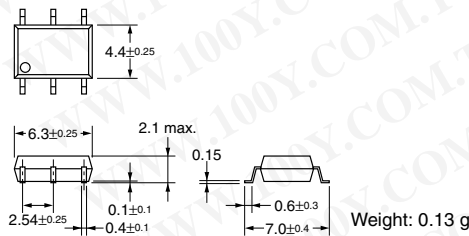

### Terminal Arrangement/Internal Connections (Top View)

**G3VM-41HR**

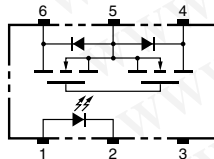

### Actual Mounting Pad Dimensions (Recommended Value, Top View)

**G3VM-41HR**

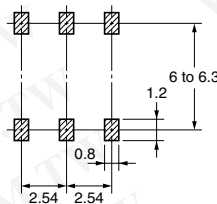

勝特力材料 886-3-5753170  
 勝特力电子(上海) 86-21-34970699  
 勝特力电子(深圳) 86-755-83298787  
[Http://www.100y.com.tw](http://www.100y.com.tw)

### Absolute Maximum Ratings (Ta = 25°C)

Item		Symbol	Rating	Unit	Measurement Conditions	
Input	LED forward current	$I_F$	30	mA		
	LED forward current reduction rate	$\Delta I_F/^\circ\text{C}$	-0.3	mA/°C	Ta ≥ 25°C	
	LED reverse voltage	$V_R$	5	V		
	Connection temperature	$T_j$	125	°C		
Output	Load voltage (AC peak/DC)	$V_{OFF}$	40	V		
	Continuous load current	Connection A	$I_O$	2.5	A	Connection A: AC peak/DC Connection B and C: DC
		Connection B		2.5		
		Connection C		5		
	ON current reduction rate	Connection A	$\Delta I_O/^\circ\text{C}$	-33.3	mA/°C	Ta ≥ 50°C
		Connection B		-33.3		
		Connection C		-66.7		
Pulse on current	$I_{op}$	7.5	A	t = 100 ms		
Connection temperature	$T_j$	125	°C			
Dielectric strength between input and output (See note 1.)		$V_{I-O}$	1,500	Vrms	AC for 1 min	
Operating temperature		$T_a$	-40 to +85	°C	With no icing or condensation	
Storage temperature		$T_{stg}$	-55 to +125	°C	With no icing or condensation	
Soldering temperature (10 s)		---	260	°C	10 s	

**Note:** 1. The dielectric strength between the input and output was checked by applying voltage between all pins as a group on the LED side and all pins as a group on the light-receiving side.

Connection Diagram

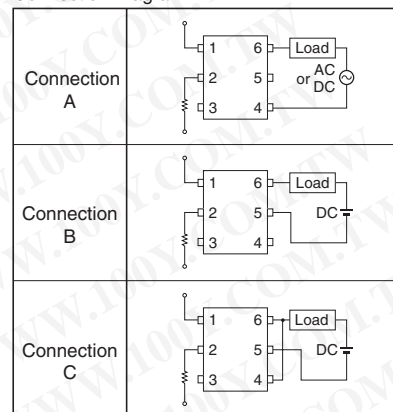

### Electrical Characteristics (Ta = 25°C)

Item		Symbol	Minimum	Typical	Maximum	Unit	Measurement conditions	
Input	LED forward voltage	$V_F$	1.18	1.33	1.48	V	$I_F = 10 \text{ mA}$	
	Reverse current	$I_R$	---	---	10	μA	$V_R = 5 \text{ V}$	
	Capacity between terminals	$C_T$	---	70	---	pF	$V = 0, f = 1 \text{ MHz}$	
	Trigger LED forward current	$I_{FT}$	---	0.4	3	mA	$I_O = 100 \text{ mA}$	
Output	Maximum resistance with output ON	Connection A	$R_{ON}$	---	0.03	0.06	Ω	$I_F = 5 \text{ mA}, I_O = 2 \text{ A}, t < 1 \text{ s}$
		Connection B		---	0.015	0.03	Ω	$I_F = 5 \text{ mA}, I_O = 2 \text{ A}, t < 1 \text{ s}$
		Connection C		---	0.008	---	Ω	$I_F = 5 \text{ mA}, I_O = 4 \text{ A}, t < 1 \text{ s}$
Current leakage when the relay is open		$I_{LEAK}$	---	---	10	nA	$V_{OFF} = 40 \text{ V}$	
Capacity between I/O terminals		$C_{I-O}$	---	0.8	---	pF	$f = 1 \text{ MHz}, V_S = 0 \text{ V}$	
Insulation resistance		$R_{I-O}$	1,000	---	---	MΩ	$V_{I-O} = 500 \text{ VDC}, \text{RoH} \leq 60\%$	
Turn-ON time		$t_{ON}$	---	1.0	5.0	ms	$I_F = 5 \text{ mA}, R_L = 200 \text{ } \Omega, V_{DD} = 20 \text{ V}$ (See note 2.)	
Turn-OFF time		$t_{OFF}$	---	0.15	1.0	ms		

**Note:** 2. Turn-ON and Turn-OFF Times

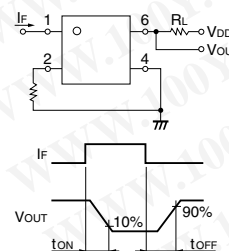

### Recommended Operating Conditions

Use the G3VM under the following conditions so that the Relay will operate properly.

Item	Symbol	Minimum	Typical	Maximum	Unit
Load voltage (AC peak/DC)	$V_{DD}$	---	---	40	V
Operating LED forward current	$I_F$	5	7.5	20	mA
Continuous load current (AC peak/DC)	$I_O$	---	---	2	A
Operating temperature	$T_a$	-20	---	65	°C

### Engineering Data

#### Load Current vs. Ambient Temperature

G3VM-41HR

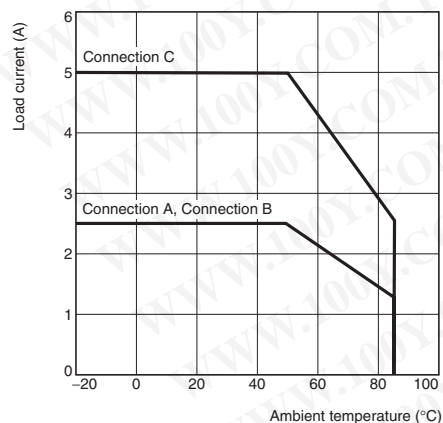

### Safety Precautions

Refer to "Common Precautions" for all G3VM models.