

New



Vertical type  
(coil: lead wire)



Horizontal type  
(coil: faston terminal)

RoHS compliant

### FEATURES

- **Low operation noise**  
Compared to our previous product, ON noise has been reduced approx. 13 dB and OFF noise has been reduced approx. 5 dB.
- **Vertical and horizontal types available**  
Offers freedom of relay layout where space is restricted.
- **Compact and lightweight**  
Charged with hydrogen gas for high arc cooling capacity, short gap cutoff has been achieved at high DC voltages.
- **Capsule contact construction for safety and high contact reliability**  
High safety achieved with construction that prevents explosions by keeping the arc from leaking.  
Since the contact portion is sealed in hydrogen gas, there is no contact oxidation. It is also dustproof and waterproof.

### TYPICAL APPLICATIONS

- Hybrid vehicle
- Small sized electric vehicle
- High DC voltage applications such as battery charge and discharge systems
- High-voltage accessories

### ORDERING INFORMATION

AEVS   0

Contact arrangement / Installation type  
1: 1 Form A (Screw terminal, Vertical type)  
9: 1 Form A (Screw terminal, Horizontal type)

Contact rating  
6: 60 A

Coil voltage  
12: 12V DC

Coil terminal structure  
Nil: Lead wire  
2: Faston terminal

勝特力材料 886-3-5753170  
勝特力电子(上海) 86-21-34970699  
勝特力电子(深圳) 86-755-83298787  
[Http://www.100y.com.tw](http://www.100y.com.tw)

### TYPES

Contact rating	Nominal coil voltage	Contact arrangement	Installation type	Part No.
60 A	12 V DC	1 Form A	Vertical type	AEVS16012
			Horizontal type	AEVS960122

Standard packing; Carton: 1pc. Case: 20pcs

# EV (AEVS)

## RATING

### 1. Coil data

Type	Nominal coil voltage	Pick-up voltage (at 20°C 68°F)	Drop-out voltage (at 20°C 68°F)	Nominal operating current [±10%] (at 20°C 68°F)	Nominal operating power (at 20°C 68°F)	Max. allowable voltage*1
60 A	12 V DC	Max. 9 V DC	Min. 1 V DC	0.375A	4.5 W	16 V DC

Note: \*1. When continually powered, the maximum allowable voltage is 14 V DC (at 65°C 149°F).

### 2. Specifications

Characteristics	Item	Specifications	
		Vertical type	Horizontal type
Contact rating	Contact arrangement	1 Form A	
	Nominal switching capacity (resistive load)	60A 400V DC	
	Short term carrying current	100A 10 min., 180A 1 min. (15mm <sup>2</sup> Wire)	
	Min. switching capacity (resistive load)	1A 12V DC*1	
	Max. shutoff current	600A 300V DC (Min. 5 cycles)*2, *3	
	Overload opening/closing rating	120A 400V DC (Min. 50 cycles)*2, *3	
	Reverse direction shutoff	-120A 200V DC (Min. 50 cycles)*2, *3	
	Contact voltage drop (Initial)	Max. 0.067 V (By voltage drop 6 V DC 20A)	
Electrical characteristics	Insulation resistance (Initial)	Min. 100MΩ (at 500 V DC, Measurement at same location as "Initial breakdown voltage" section.)	
	Breakdown voltage (Initial)	Between open contacts	2,500Vrms/min. (Detection current: 10mA)
		Between contact and coil	2,000Vrms/min. (Detection current: 10mA)
	Operate time (at 20°C 68°F)	Max. 50ms (Nominal coil voltage applied to the coil, excluding contact bounce time)	
Release time (at 20°C 68°F)	Max. 50ms (Nominal coil voltage applied to the coil, without diode)		
Mechanical characteristics	Shock resistance	Functional	For ON: Min. 196m/s <sup>2</sup> {20 G} (Half-wave pulse of sine wave: 11ms; detection time: 10μs) For OFF: Min. 98m/s <sup>2</sup> {10 G} (Half-wave pulse of sine wave: 11ms; detection time: 10μs)
		Destructive	Min. 490 m/s <sup>2</sup> {50 G} (Half-wave pulse of sine wave: 6ms)
	Vibration resistance	Functional	10 to 100 Hz, acceleration: 43 m/s <sup>2</sup> {4.4 G} 100 to 200 Hz, acceleration: 19.6 m/s <sup>2</sup> {2 G} (Detection time: 10μs)
		Destructive	10 to 100 Hz, acceleration: 43 m/s <sup>2</sup> {4.4 G} 100 to 200 Hz, acceleration: 19.6 m/s <sup>2</sup> {2 G} (Time of vibration for each direction; X, Y, Z direction: 4 hours)
Expected life	Mechanical	Min. 2×10 <sup>5</sup> (at 60 cpm)	
	Electrical (resistive load)	60A 400V DC Min. 800 cycles	
Conditions	Conditions for operation	Ambient temperature: -40 to +80°C -40 to +176°F (-40 to +65°C -40 to +149°F when continually powered at 14 V DC.) Humidity: 5 to 85% R.H. (Not freezing and condensing at low temperature)	
	Conditions for transport and storage	Ambient temperature: -40 to +80°C -40 to +176°F Humidity: 5 to 85% R.H. (Not freezing and condensing at low temperature)	
Mass (Approx.)		250 g 8.82 oz	240 g 8.47 oz

Notes: \*1. This value can change due to the switching frequency, environmental conditions, and desired reliability level, therefore it is recommended to check this with the actual load.

\*2. The electrical performance value applies when a varistor is connected in parallel to the coil. Please be warned that working life will be reduced when a diode is used.

\*3. At L/R ≤ 1ms

**REFERENCE DATA**

1. Ambient temperature characteristics  
3 pcs.

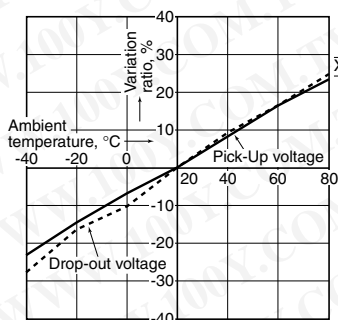

2. Max. value for switching capacity

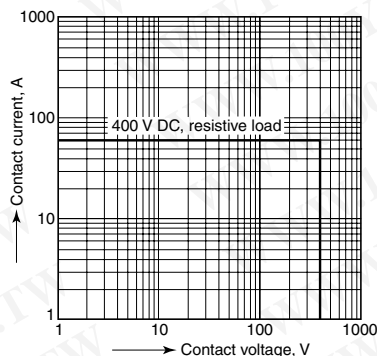

3. Switching life curve

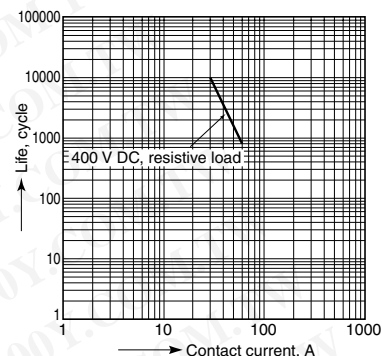

4. Shutoff life curve (forward direction)

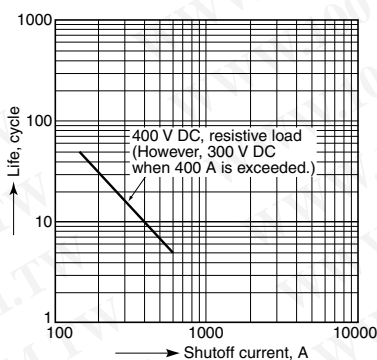

5. Carrying performance curve (80°C 176°F)

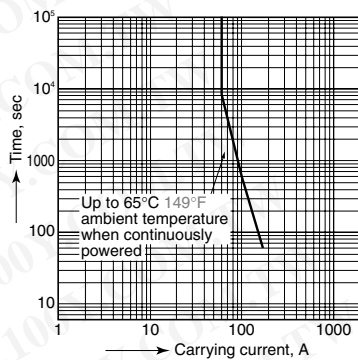

6.-(1)-1 Operation noise distribution (vertical type)

When operate

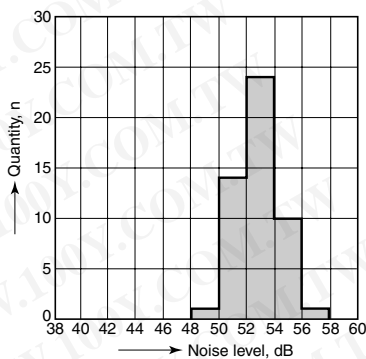

6.-(1)-2 Operation noise distribution (vertical type)

When release

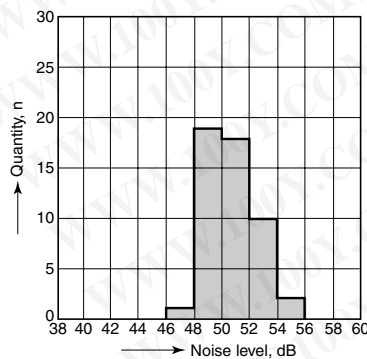

Vertical type

Measuring conditions  
Sample: AEVS16012, 50pcs  
Equipment setting: "A" weighted, Fast, Max. hold  
Coil voltage: 12 V DC  
Coil connection device: 18 V zener diode  
Background noise: approx. 20dB

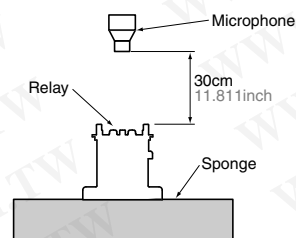

6.-(2)-1 Operation noise distribution (horizontal type)

When operate

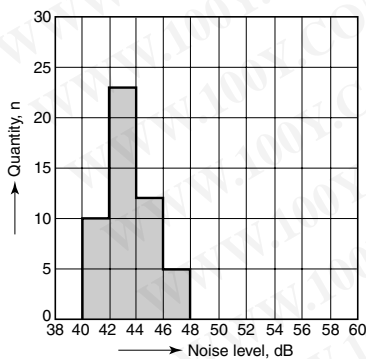

6.-(2)-2 Operation noise distribution (horizontal type)

When release

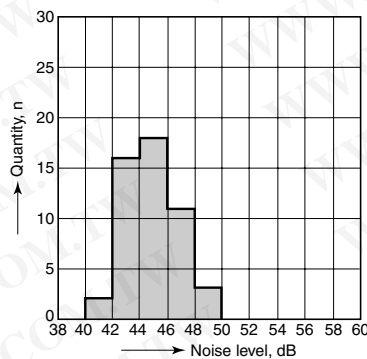

Horizontal type

Measuring conditions  
Sample: AEVS96012, 50pcs  
Equipment setting: "A" weighted, Fast, Max. hold  
Coil voltage: 12 V DC  
Coil connection device: 18 V zener diode  
Background noise: approx. 20dB

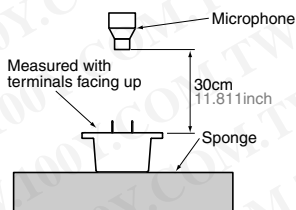

# EV (AEVS)

## DIMENSIONS (mm inch)

The CAD data of the products with a **CAD Data** mark can be downloaded from: <http://industrial.panasonic.com/ac/e/>

### 1. 60 A Vertical type

**CAD Data**

#### External dimensions

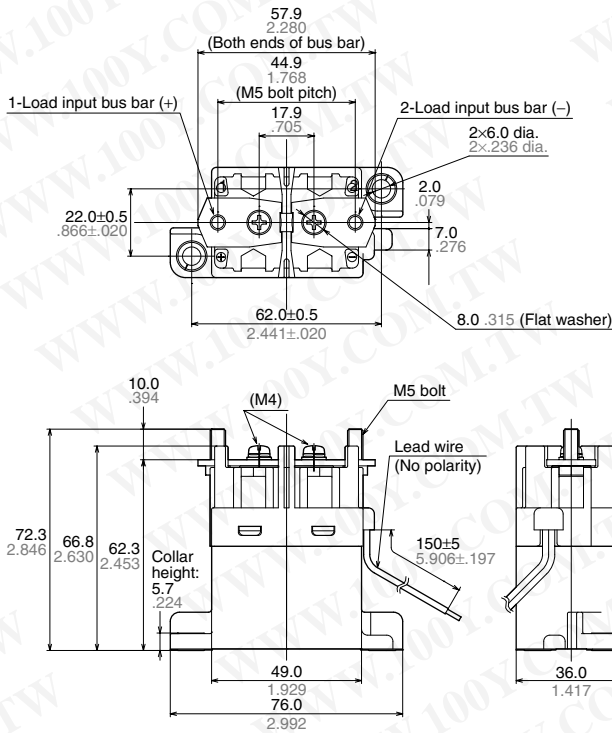

#### Schematic (TOP VIEW)

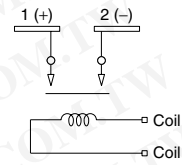

#### Mounting dimensions

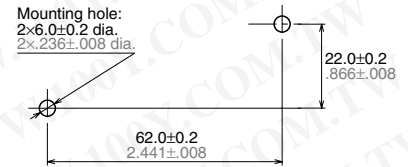

#### General tolerance:

less than 10 .394:  $\pm 0.3 \pm .012$   
 10 to 50 .394 to 1.969:  $\pm 0.6 \pm .024$   
 more than 50 1.969:  $\pm 1.0 \pm .039$

### 2. 60 A Horizontal type

**CAD Data**

#### External dimensions

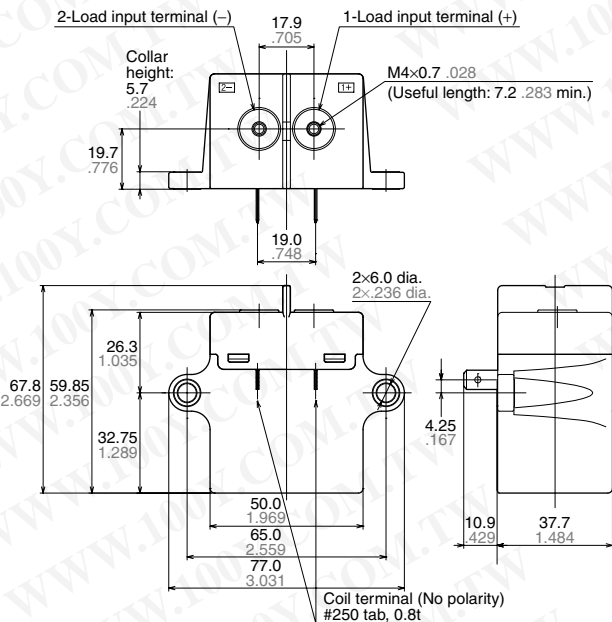

#### Schematic (TOP VIEW)

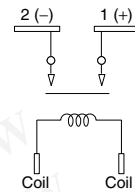

#### Mounting dimensions

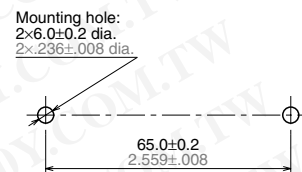

#### General tolerance:

less than 10 .394:  $\pm 0.3 \pm .012$   
 10 to 50 .394 to 1.969:  $\pm 0.6 \pm .024$   
 more than 50 1.969:  $\pm 1.0 \pm .039$

## NOTES

### 1. Usage, transport and storage conditions

- 1) Temperature:  $-40$  to  $+80^{\circ}\text{C}$   $-40$  to  $+176^{\circ}\text{F}$  ( $-40$  to  $+65^{\circ}\text{C}$   $-40$  to  $+149^{\circ}\text{F}$  when continually powered at 14 V DC)
- 2) Humidity: 5 to 85% RH (Avoid freezing and condensation.)  
The humidity range varies with the temperature. Use within the range indicated in the graph below.
- 3) Atmospheric pressure: 86 to 106 kPa  
Temperature and humidity range for usage, transport, and storage

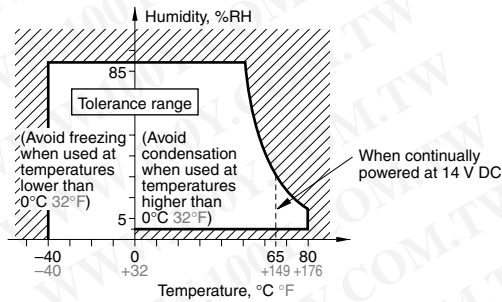

### 4) Condensation

Condensation forms when there is a sudden change in temperature under high temperature and high humidity conditions. Condensation will cause deterioration of the relay insulation.

### 5) Low temperature, low humidity environments

The plastic becomes brittle if the relay is exposed to a low temperature, low humidity environment for long periods of time.

### 2. Condition of tightening screw

- 1) Tightening torque for fixing relay-body;  
Vertical and Horizontal type (M5 Screw): 3.0 to 4.0 N·m
- 2) Tightening torque for contact terminal;  
Vertical type (M5 screw): 3.0 to 4.0 N·m,  
Horizontal type (M4 screw): 2.2 to 2.8 N·m

### 3. Allowable pulling force for the coil input lead wire:

**Max. 10N (for vertical type)**

### 4. Insertion strength into the tab terminal: Max. 49N (for horizontal type)

Reference: Please select a faston terminal (flat connection terminal) which comply with JIS C2809-1999.

For plate thickness 0.8mm .031inch and #250 tab terminal

### 5. Cautions for use

- 1) Regarding cautions for use and explanation of technical terms, please refer to our general catalog.
- 2) Additionally the ambient temperature and condition for your application should be considered because pick-up and drop-out voltage will be changed.
- 3) If it includes ripple, the ripple factor should be less than 5%.  
For coil surge absorption, please use a zener diode or varistor, etc., so that the clamp voltage reaches 1.5 times or more (at least 18 V for rated 12 V type) the rated operation voltage. If only a diode is connected in parallel with the relay coil, the contact opening velocity will become slow and sufficient cutoff performance cannot be guaranteed. Please avoid such usage.

### Ex. 1: When using a varistor

Recommended Varistor; Maximum Energy: more than 1J  
(However, please make settings using values that take into consideration the worst case scenario.)

Varistor voltage: For 12 V DC input, Min. 18 V

### Ex. 2: When using a zener diode (circuit)

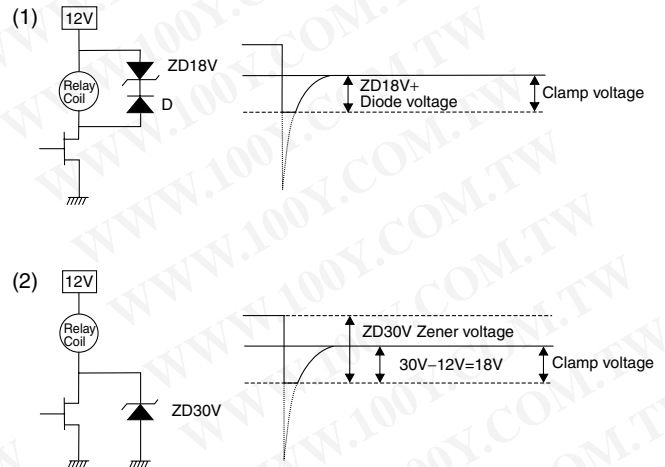

### 4) Lifetime is specified under the standard test conditions in JIS C 5442. (temperature 15 to 35°C 59 to 95°F, humidity 25%RH to 85%RH)

Lifetime is dependent on the coil driving circuit, load type, operation frequency and ambient conditions. Check lifetime under the actual condition.

Especially, Contact terminals have polarity. So if the contact terminals were connected with opposite pole, the electric life would be shorter.

5) When applying current which includes precipitous changes or ripple, the relay may generate buzzing sound. Therefore, please confirm with the actual load.

6) If the relay is used while exceeding the coil rating, contact rating or cycle lifetime, this may result in the risk of overheating.

7) As a general rule, do not use a relay if it has been dropped.

8) Take care to avoid cross connections as they may cause malfunctions or overheating.

9) When the screws for fixing relay-body and for additional terminal are tightened, it should be used within the range of decided torque.

10) Avoid mounting the relay in strong magnetic fields (near a transformer or magnet) or close to an object that radiates heat.

11) If the several relays are mounted closely or a heat-generation object is close to the relay, take care to check the abnormal temperature-rise and the insulation distance between the terminals outside of the relay.

12) The relay contacts are encapsulated in an inert gas atmosphere. Care must be exercised when the relay is to be used or stored at high ambient temperature.

13) If the power is turned off and then immediately on after applying the rated voltage (current) continuously to the relay's coil and contact, the resistance of the coil will increase due to a rise in the coil temperature.

This causes the pick-up voltage to rise, and possibly exceed the rated pick-up voltage. In these circumstances, take measures such as reducing the load current, limiting the duration of current flow, and applying a coil voltage higher than the rated operating voltage (quick start).

## EV (AEVS)

---

14) In case using a capacitive load (C-load), please take a countermeasure as pre-charging to the capacitive load so that the inrush current will not surpass 60A.

The relay might have a contact welding without such countermeasure.

15) If you are using an inductive load (L load) such that  $L/R > 1\text{ms}$ , add surge protection in parallel with the inductive load. If this is not done, the electrical life will decrease and cut-off failure may occur.

16) Use the suitable wire for wire at the load side according to the current. If the wire diameter is small, the maximum rated contact current cannot be guaranteed.

(Ex.) Carrying current; 60A: diameter of 15mm<sup>2</sup> or more

17) Take care to disconnect to the power supply when wiring.

18) Do not switch the contacts without any load as the contact resistance may become increased rapidly.

19) The relay satisfies the protection level of JIS D 0203 R2 (of waterproof). Please take any countermeasures additionally if it should be installed in the place where higher protection level is required.

20) Do not use this product in such atmosphere where any kind of organic solvent (as benzene, thinner and alcohol) and the strong alkali (as ammonia and caustic soda) might be adhered to this product.

21) Be careful that foreign matter and oils and fats kind don't stick to the main terminal parts because it is likely to cause terminal parts to give off unusual heat.

22) Do not make additional manufacturing upon the relay housing.

23) For AC shutoff there is no contact polarity, but confirm the electric life using the actual load.