

# Darlington Complementary Silicon Power Transistors

... designed for general-purpose amplifier and low-frequency switching applications.

- High DC Current Gain @  $I_C = 10 \text{ Adc}$  —  
 $h_{FE} = 2400$  (Typ) — 2N6282, 2N6283, 2N6284  
 $= 4000$  (Typ) — 2N6285, 2N6286, 2N6287
- Collector-Emitter Sustaining Voltage —  
 $V_{CEO(sus)} = 60 \text{ Vdc}$  (Min) — 2N6282, 2N6285  
 $= 80 \text{ Vdc}$  (Min) — 2N6283, 2N6286  
 $= 100 \text{ Vdc}$  (Min) — 2N6284, 2N6287
- Monolithic Construction with Built-In Base-Emitter Shunt Resistors

## \*MAXIMUM RATINGS

Rating	Symbol	2N6282 2N6285	2N6283 2N6286	2N6284 2N6287	Unit
Collector-Emitter Voltage	$V_{CEO}$	60	80	100	Vdc
Collector-Base Voltage	$V_{CB}$	60	80	100	Vdc
Emitter-Base Voltage	$V_{EB}$	5.0			Vdc
Collector Current — Continuous Peak	$I_C$	20 40			A <sub>dc</sub>
Base Current	$I_B$	0.5			A <sub>dc</sub>
Total Device Dissipation @ $T_C = 25^\circ\text{C}$ Derate above $25^\circ\text{C}$	$P_D$	160 0.915			Watts W/ $^\circ\text{C}$
Operating and Storage Junction Temperature Range	$T_J, T_{stg}$	-65 to +200			$^\circ\text{C}$

## \*THERMAL CHARACTERISTICS

Characteristic	Symbol	Max	Unit
Thermal Resistance, Junction to Case	$R_{\theta JC}$	1.09	$^\circ\text{C/W}$

\* Indicates JEDEC Registered Data.

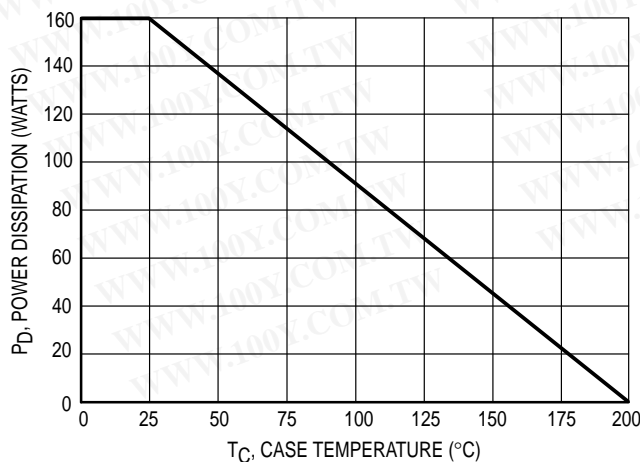

Figure 1. Power Derating

Preferred devices are Motorola recommended choices for future use and best overall value.

**NPN**  
**2N6282**

thru

**2N6284\***  
**PNP**  
**2N6285**

thru

**2N6287\***

\*Motorola Preferred Device

**DARLINGTON**  
**20 AMPERE**  
**COMPLEMENTARY**  
**SILICON**  
**POWER TRANSISTORS**  
**60, 80, 100 VOLTS**  
**160 WATTS**

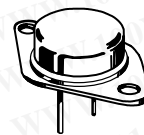

**CASE 1-07**  
**TO-204AA**  
**(TO-3)**

## 2N6282 thru 2N6284 2N6285 thru 2N6287

\*ELECTRICAL CHARACTERISTICS ( $T_C = 25^\circ\text{C}$  unless otherwise noted)

Characteristic	Symbol	Min	Max	Unit
<b>OFF CHARACTERISTICS</b>				
Collector-Emitter Sustaining Voltage ( $I_C = 0.1 \text{ A dc}$ , $I_B = 0$ )	$V_{CE(sus)}$	60 80 100	—	Vdc
Collector Cutoff Current ( $V_{CE} = 30 \text{ Vdc}$ , $I_B = 0$ ) ( $V_{CE} = 40 \text{ Vdc}$ , $I_B = 0$ ) ( $V_{CE} = 50 \text{ Vdc}$ , $I_B = 0$ )	$I_{CEO}$	— — —	1.0 1.0 1.0	mAdc
Collector Cutoff Current ( $V_{CE} = \text{Rated } V_{CB}$ , $V_{BE(off)} = 1.5 \text{ Vdc}$ ) ( $V_{CE} = \text{Rated } V_{CB}$ , $V_{BE(off)} = 1.5 \text{ Vdc}$ , $T_C = 150^\circ\text{C}$ )	$I_{CEX}$	— —	0.5 5.0	mAdc
Emitter Cutoff Current ( $V_{BE} = 5.0 \text{ Vdc}$ , $I_C = 0$ )	$I_{EBO}$	—	2.0	mAdc

### ON CHARACTERISTICS (1)

DC Current Gain ( $I_C = 10 \text{ A dc}$ , $V_{CE} = 3.0 \text{ Vdc}$ ) ( $I_C = 20 \text{ A dc}$ , $V_{CE} = 3.0 \text{ Vdc}$ )	$h_{FE}$	750 100	18,000 —	—
Collector-Emitter Saturation Voltage ( $I_C = 10 \text{ A dc}$ , $I_B = 40 \text{ mA dc}$ ) ( $I_C = 20 \text{ A dc}$ , $I_B = 200 \text{ mA dc}$ )	$V_{CE(sat)}$	— —	2.0 3.0	Vdc
Base-Emitter On Voltage ( $I_C = 10 \text{ A dc}$ , $V_{CE} = 3.0 \text{ Vdc}$ )	$V_{BE(on)}$	—	2.8	Vdc
Base-Emitter Saturation Voltage ( $I_C = 20 \text{ A dc}$ , $I_B = 200 \text{ mA dc}$ )	$V_{BE(sat)}$	—	4.0	Vdc

**勝特力材料 886-3-5753170**  
**勝特力电子(上海) 86-21-54151736**  
**勝特力电子(深圳) 86-755-83298787**  
[Http://www.100y.com.tw](http://www.100y.com.tw)

### DYNAMIC CHARACTERISTICS

Magnitude of Common Emitter Small-Signal Short-Circuit Forward Current Transfer Ratio ( $I_C = 10 \text{ A dc}$ , $V_{CE} = 3.0 \text{ Vdc}$ , $f = 1.0 \text{ MHz}$ )	$ h_{fe} $	4.0	—	MHz
Output Capacitance ( $V_{CB} = 10 \text{ Vdc}$ , $I_E = 0$ , $f = 0.1 \text{ MHz}$ )	$C_{ob}$	— —	400 600	pF
Small-Signal Current Gain ( $I_C = 10 \text{ A dc}$ , $V_{CE} = 3.0 \text{ Vdc}$ , $f = 1.0 \text{ kHz}$ )	$h_{fe}$	300	—	—

\* Indicates JEDEC Registered Data.

(1) Pulse test: Pulse Width = 300  $\mu\text{s}$ , Duty Cycle = 2%

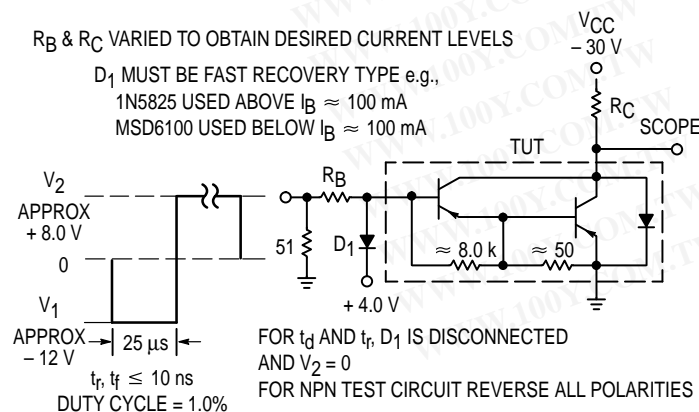

Figure 2. Switching Times Test Circuit

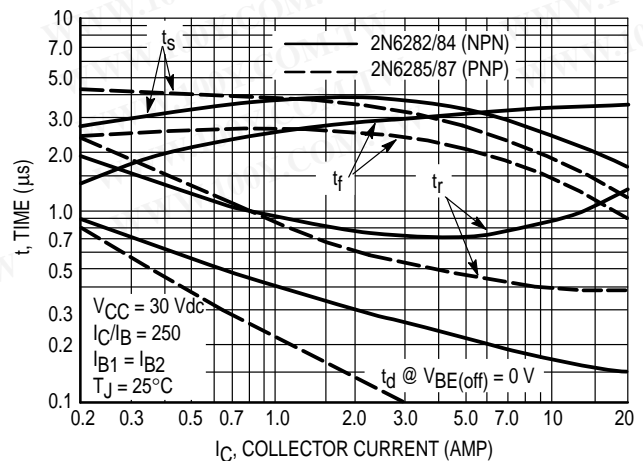

Figure 3. Switching Times

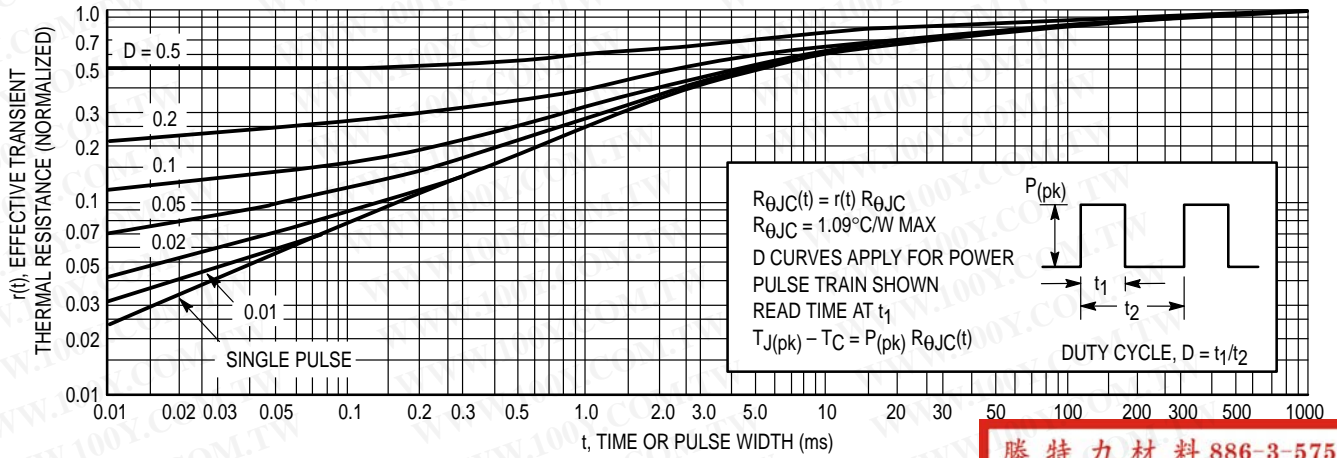

Figure 4. Thermal Response

勝特力材料 886-3-5753170  
 勝特力电子(上海) 86-21-54151736  
 勝特力电子(深圳) 86-755-83298787  
[Http://www.100y.com.tw](http://www.100y.com.tw)

ACTIVE-REGION SAFE OPERATING AREA

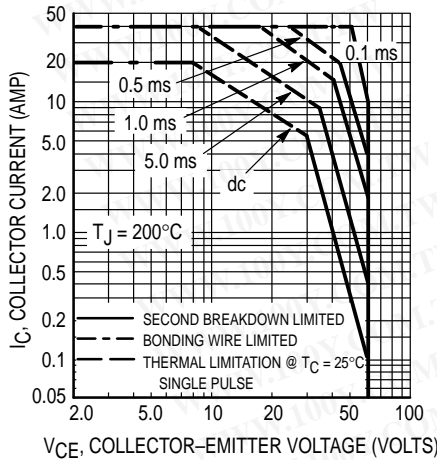

Figure 5. 2N6282, 2N6285

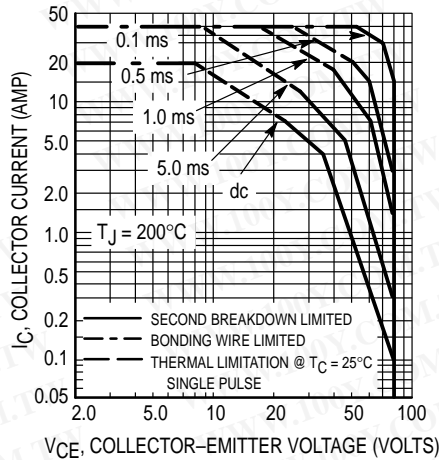

Figure 6. 2N6283, 2N6286

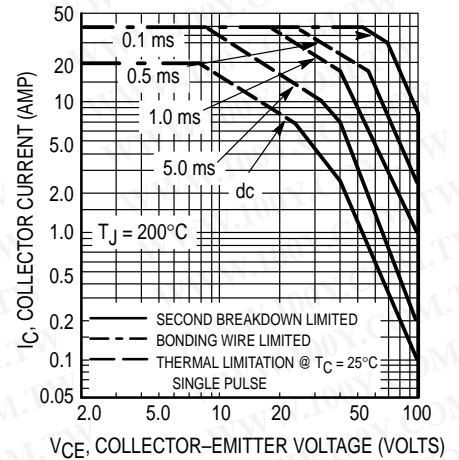

Figure 7. 2N6284, 2N6287

There are two limitations on the power handling ability of a transistor: average junction temperature and second breakdown. Safe operating area curves indicate  $I_C - V_{CE}$  limits of the transistor that must be observed for reliable operation; i.e. the transistor must not be subjected to greater dissipation than the curves indicate.

The data of Figures 5, 6 and 7 is based on  $T_{J(pk)} = 200^\circ\text{C}$ ;  $T_C$  is variable depending on conditions. Second breakdown pulse limits are valid for duty cycles to 10% provided  $T_{J(pk)} < 200^\circ\text{C}$ .  $T_{J(pk)}$  may be calculated from the data in Figure 4. At high case temperatures, thermal limitations will reduce the power that can be handled to values less than the limitations imposed by second breakdown.

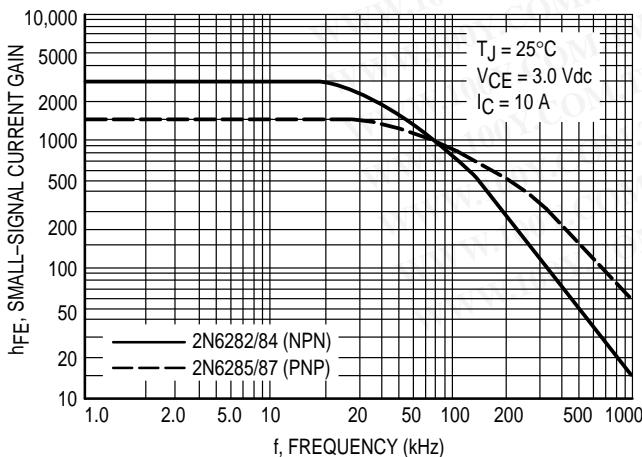

Figure 8. Small-Signal Current Gain

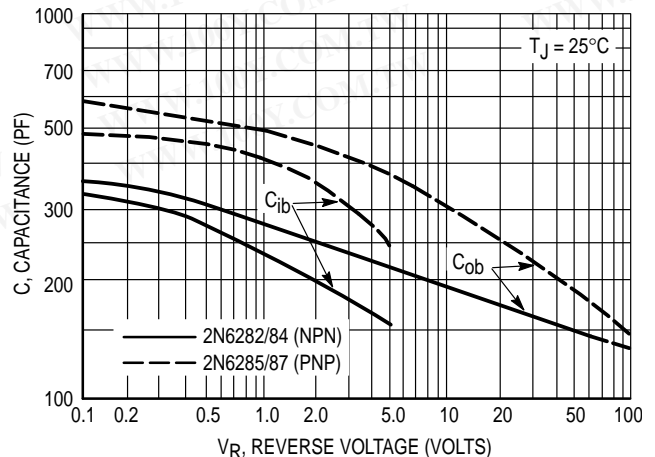
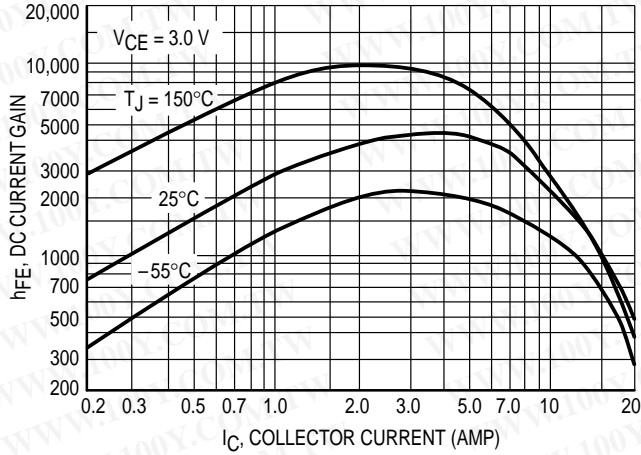

Figure 9. Capacitance



**2N6282 thru 2N6284 2N6285 thru 2N6287**

**NPN**  
2N6282, 2N6283, 2N6284



**PNP**  
2N6285, 2N6286, 2N6287

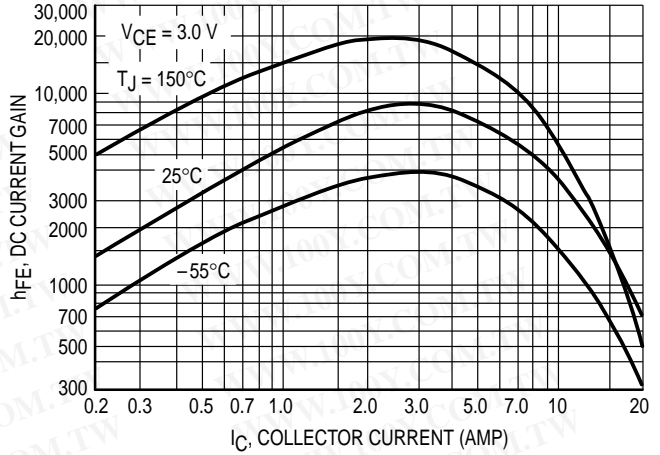

**Figure 10. DC Current Gain**

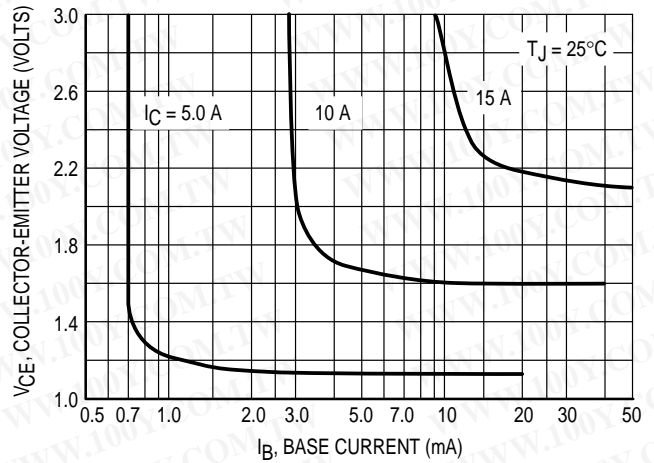
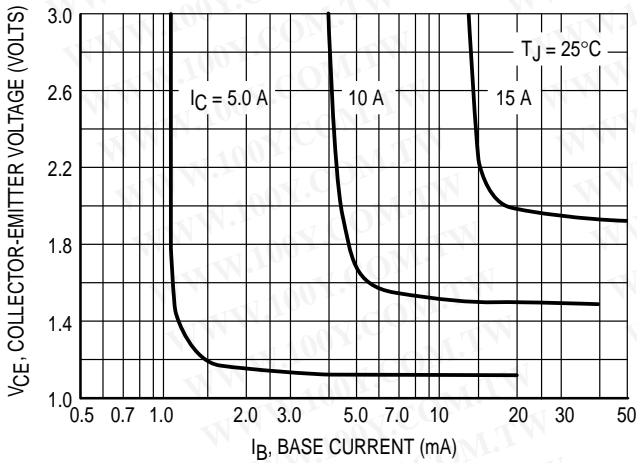

**Figure 11. Collector Saturation Region**

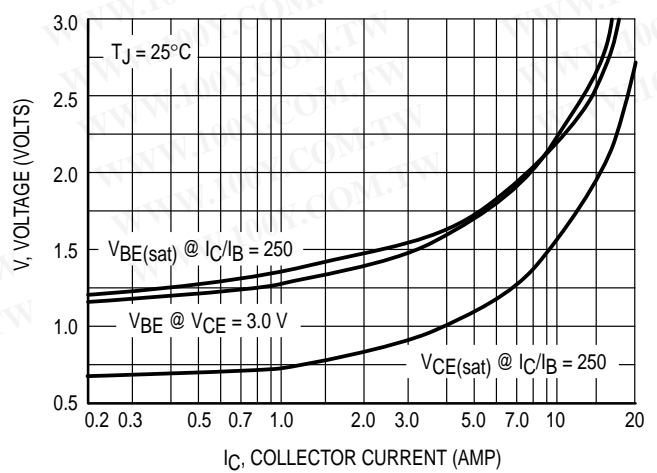
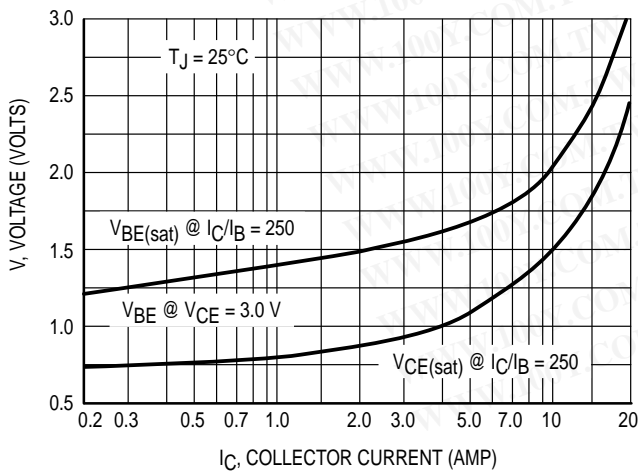

**Figure 12. "On" Voltages**

勝特力材料 886-3-5753170  
 勝特力电子(上海) 86-21-54151736  
 勝特力电子(深圳) 86-755-83298787  
[Http://www.100y.com.tw](http://www.100y.com.tw)

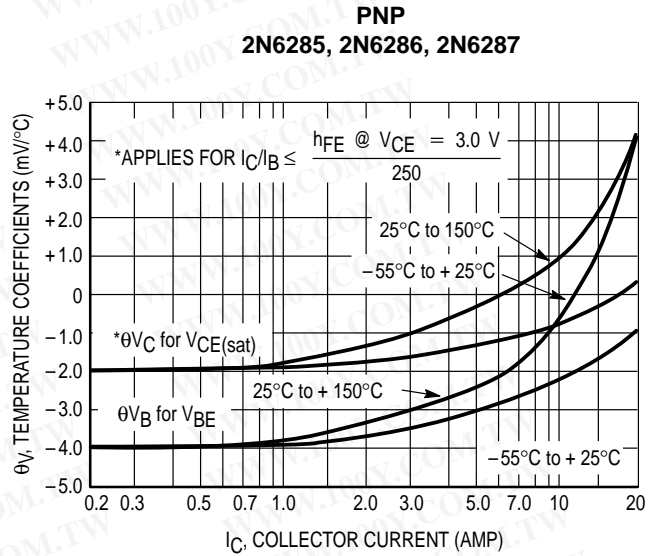
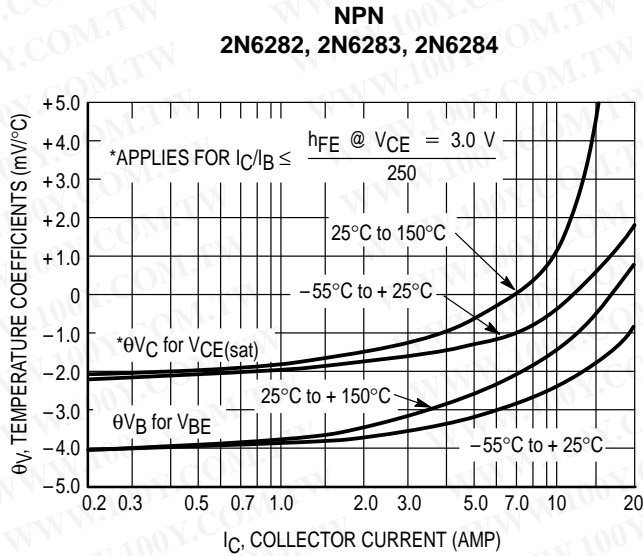

Figure 13. Temperature Coefficients

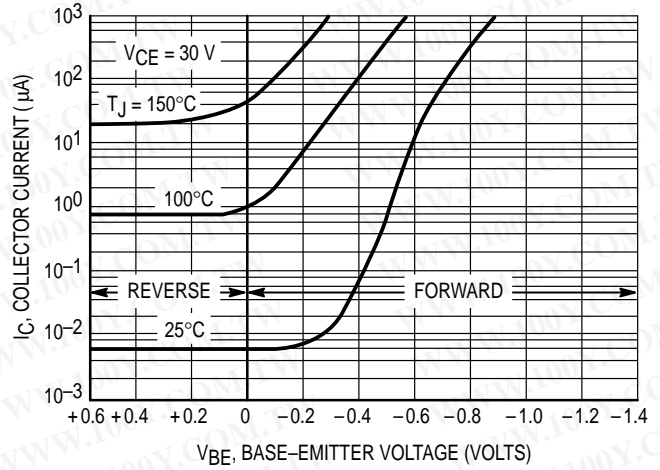
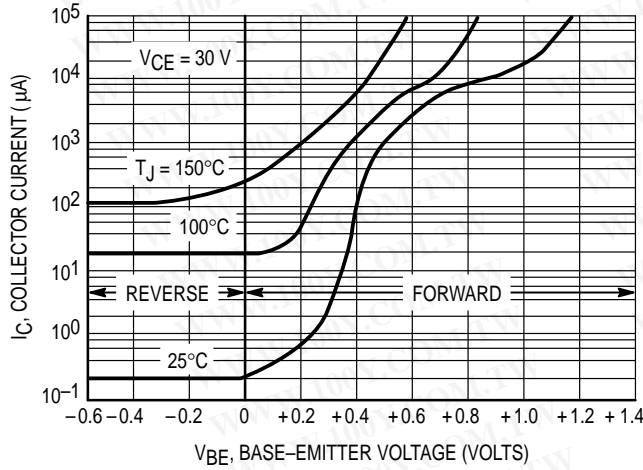

Figure 14. Collector Cut-Off Region

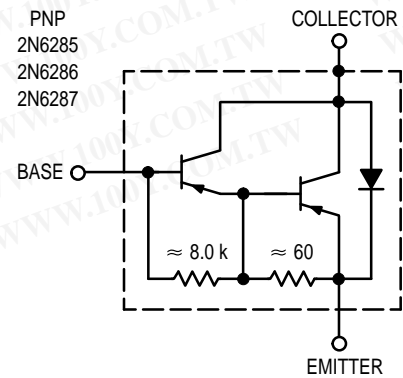
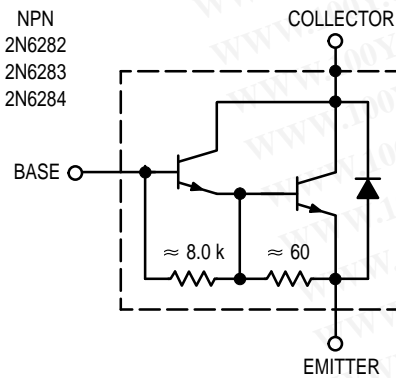
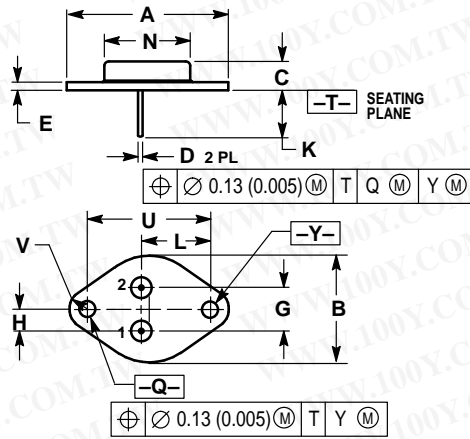

Figure 15. Darlington Schematic

勝特力材料 886-3-5753170  
 勝特力电子(上海) 86-21-54151736  
 勝特力电子(深圳) 86-755-83298787  
[Http://www.100y.com.tw](http://www.100y.com.tw)

2N6282 thru 2N6284 2N6285 thru 2N6287

PACKAGE DIMENSIONS



- NOTES:
1. DIMENSIONING AND TOLERANCING PER ANSI Y14.5M, 1982.
  2. CONTROLLING DIMENSION: INCH.
  3. ALL RULES AND NOTES ASSOCIATED WITH REFERENCED TO-204AA OUTLINE SHALL APPLY.

DIM	INCHES		MILLIMETERS	
	MIN	MAX	MIN	MAX
A	1.550 REF		39.37 REF	
B	—	1.050	—	26.67
C	0.250	0.335	6.35	8.51
D	0.038	0.043	0.97	1.09
E	0.055	0.070	1.40	1.77
G	0.430 BSC		10.92 BSC	
H	0.215 BSC		5.46 BSC	
K	0.440	0.480	11.18	12.19
L	0.665 BSC		16.89 BSC	
N	—	0.830	—	21.08
Q	0.151	0.165	3.84	4.19
U	1.187 BSC		30.15 BSC	
V	0.131	0.188	3.33	4.77

STYLE 1:  
 PIN 1. BASE  
 2. EMITTER  
 CASE: COLLECTOR

CASE 1-07  
 TO-204AA (TO-3)  
 ISSUE Z

勝特力材料 886-3-5753170  
 勝特力电子(上海) 86-21-54151736  
 勝特力电子(深圳) 86-755-83298787  
[Http://www.100y.com.tw](http://www.100y.com.tw)

Motorola reserves the right to make changes without further notice to any products herein. Motorola makes no warranty, representation or guarantee regarding the suitability of its products for any particular purpose, nor does Motorola assume any liability arising out of the application or use of any product or circuit, and specifically disclaims any and all liability, including without limitation consequential or incidental damages. "Typical" parameters can and do vary in different applications. All operating parameters, including "Typicals" must be validated for each customer application by customer's technical experts. Motorola does not convey any license under its patent rights nor the rights of others. Motorola products are not designed, intended, or authorized for use as components in systems intended for surgical implant into the body, or other applications intended to support or sustain life, or for any other application in which the failure of the Motorola product could create a situation where personal injury or death may occur. Should Buyer purchase or use Motorola products for any such unintended or unauthorized application, Buyer shall indemnify and hold Motorola and its officers, employees, subsidiaries, affiliates, and distributors harmless against all claims, costs, damages, and expenses, and reasonable attorney fees arising out of, directly or indirectly, any claim of personal injury or death associated with such unintended or unauthorized use, even if such claim alleges that Motorola was negligent regarding the design or manufacture of the part. Motorola and are registered trademarks of Motorola, Inc. Motorola, Inc. is an Equal Opportunity/Affirmative Action Employer.

How to reach us:  
 USA/EUROPE: Motorola Literature Distribution;  
 P.O. Box 20912; Phoenix, Arizona 85036. 1-800-441-2447

JAPAN: Nippon Motorola Ltd.; Tatsumi-SPD-JLDC, Toshikatsu Otsuki,  
 6F Seibu-Butsuryu-Center, 3-14-2 Tatsumi Koto-Ku, Tokyo 135, Japan. 03-3521-8315

MFAX: RMFAX0@email.sps.mot.com - TOUCHTONE (602) 244-6609  
 INTERNET: <http://Design-NET.com>

HONG KONG: Motorola Semiconductors H.K. Ltd.; 8B Tai Ping Industrial Park,  
 51 Ting Kok Road, Tai Po, N.T., Hong Kong. 852-26629298



2N6282/D

