

THYRISTORS

2P4M, 2P5M, 2P6M

2 A(4 A_{r.m.s.}) PLASTIC MOLDED THYRISTOR

DESCRIPTION

The 2P4M to 2P6M are P-gate all diffused plastic molded type SCR granted average on-state current 2 Amps ($T_C = 77^\circ\text{C}$), with rated voltages up to 600 volts.

FEATURES

- Easy installation by its miniature size and thin electrode leads.
- Less holding current distribution provides free application design.
- Low cost because of mass-production.

QUALITY GRADE

Standard

Please refer to "Quality grade on NEC Semiconductor Devices" (Document number IEI-1209) published by NEC Corporation to know the specification of quality grade on the devices and its recommended applications.

APPLICATIONS

Electric blanket, Electronic jar, Various temperature control.

Electric sewing machine, Speed control of miniature type motor.

Light display equipment, Lamp dimmer such as a display for entertainment.

Automatic gas lighter, Battery charger.

Solid state static switches etc.

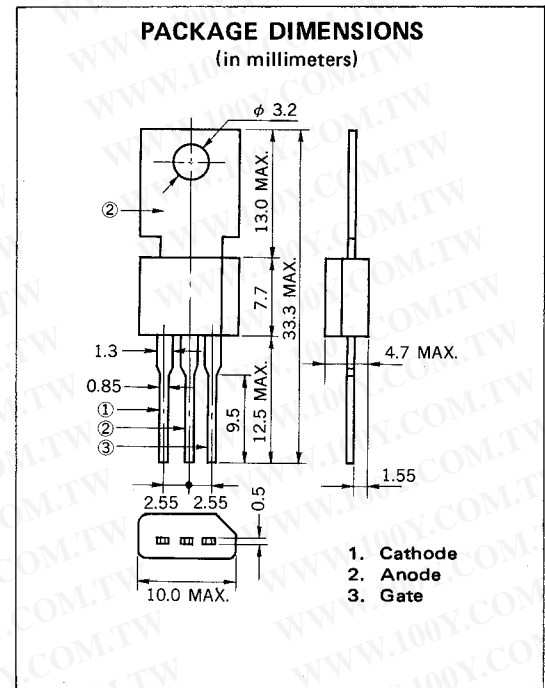

勝特力材料 886-3-5753170
 勝特力电子(上海) 86-21-54151736
 勝特力电子(深圳) 86-755-83298787
[Http://www.100y.com.tw](http://www.100y.com.tw)

ABSOLUTE MAXIMUM RATINGS ($T_a = 25\text{ }^\circ\text{C}$)

CHARACTERISTIC	SYMBOL	2P4M	2P5M	2P6M	UNIT	NOTE
Non-Repetitive Peak Reverse Voltage*	V_{RSM}	500	600	700	V	$R_{GK} = 1\text{ k}\Omega$
Non-Repetitive Peak Off-state Voltage*	V_{DSM}	500	600	700	V	$R_{GK} = 1\text{ k}\Omega$
Repetitive Peak Reverse Voltage*	V_{RRM}	400	500	600	V	$R_{GK} = 1\text{ k}\Omega$
Repetitive Peak Off-state Voltage*	V_{DRM}	400	500	600	V	$R_{GK} = 1\text{ k}\Omega$
On-state Current	$I_{T(AV)}$	2 ($T_c = 77\text{ }^\circ\text{C}$, $\theta = 180\text{ }^\circ$ Single phase (1/2 wave))			A	See Fig.3, Fig.4
Surge Non-Repetitive On-state Current	I_{TSM}	20			A	See Fig. 10
Peak Gate Power Dissipation	P_{GM}	0.5 ($f \geq 50\text{ Hz}$, Duty $\leq 10\%$)			W	
Average Gate Power Dissipation	$P_{G(AV)}$	0.1			W	
Peak Gate Forward Current	I_{FGM}	0.2 ($f \geq 50\text{ Hz}$, Duty $\leq 10\%$)			A	
Peak Gate Reverse Voltage	V_{RGM}	6			V	
Junction Temperature	T_j	-40 to +125			$^\circ\text{C}$	
Storage Temperature	T_{stg}	-55 to +150			$^\circ\text{C}$	
Weight		1.4			g	

T_c : Case Temperature is measured at 1.5 mm from the neck of Tablet.

ELECTRICAL CHARACTERISTICS ($T_a = 25\text{ }^\circ\text{C}$)

CHARACTERISTIC	SYMBOL	TEST CONDITIONS	MIN.	TYP.	MAX.	UNIT	NOTE
Repetitive Peak Reverse Current*	I_{RRM}	$V_{RM} = V_{RRM}$, $T_j = 125\text{ }^\circ\text{C}$ $R_{GK} = 1\text{ k}\Omega$	-	-	100	μA	
Repetitive Peak Off-state Current*	I_{DRM}	$V_{DM} = V_{DRM}$, $T_j = 125\text{ }^\circ\text{C}$ $R_{GK} = 1\text{ k}\Omega$	-	-	100	μA	
On-state Voltage	V_{TM}	$I_{TM} = 4\text{ A}$	-	-	2.2	V	See Fig. 1
Gate-Trigger Current*	I_{GT}	$V_{DM} = 6\text{ V}$, $R_L = 100\text{ }\Omega$ $R_{GK} = 1\text{ k}\Omega$	-	-	200	μA	See Fig. 5 Fig. 7
Gate-Trigger Voltage*	V_{GT}	$V_{DM} = 6\text{ V}$, $R_L = 100\text{ }\Omega$ $R_{GK} = 1\text{ k}\Omega$	-	-	0.8	V	See Fig. 6, Fig. 8
Gate Non-Trigger Voltage*	V_{GD}	$V_{DM} = 1/2 V_{DRM}$, $T_j = 125\text{ }^\circ\text{C}$ $R_{GK} = 1\text{ k}\Omega$	0.2	-	-	V	
Critical Rate-of-Rise of Off-state Voltage	dv/dt	$V_{DM} = 2/3 V_{DRM}$, $T_j = 125\text{ }^\circ\text{C}$ $R_{GK} = 1\text{ k}\Omega$	10	10**	-	V/ μs	** 2P5M, 2P6M
Holding Current*	I_H	$V_D = 24\text{ V}$, $R_{GK} = 1\text{ k}\Omega$ $I_{TM} = 4\text{ A}$	-	1	3	mA	See Fig. 9
Thermal Resistance	$R_{th(j-c)}$	Junction to Case	-	-	10	$^\circ\text{C/W}$	See Fig. 11
	$R_{th(j-a)}$	Junction to Ambient	-	-	75		See Fig. 11

** Note: Insert a resistance less than 1 k Ω between gate and cathode, because the items indicated are guaranteed by connecting short resistance between gate and cathode ($R_{GK} = 1\text{ k}\Omega$).

勝特力材料 886-3-5753170
 勝特力电子(上海) 86-21-54151736
 勝特力电子(深圳) 86-755-83298787
[Http://www.100y.com.tw](http://www.100y.com.tw)

EXAMPLE OF R_{GK} INSERTION

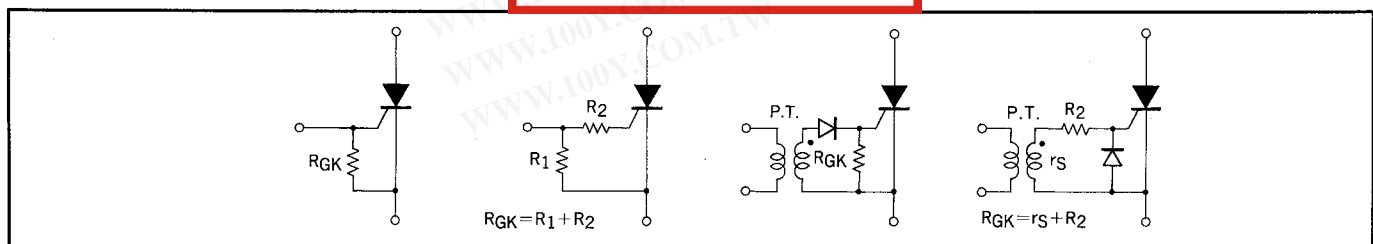

TYPICAL CHARACTERISTICS ($T_a = 25^\circ\text{C}$)

Fig. 1 $I_{TM}-V_{TM}$ CHARACTERISTICS

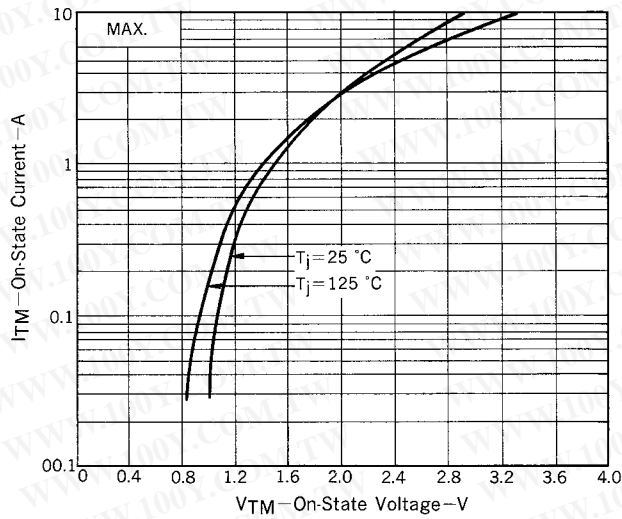

Fig. 2 $P_{T(AV)}-I_{T(AV)}$ CHARACTERISTICS

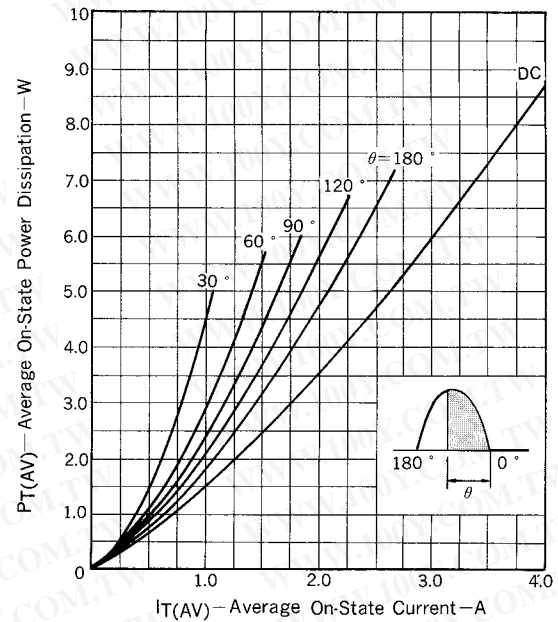

Fig. 3 $I_{T(AV)}-T_c$ RATINGS

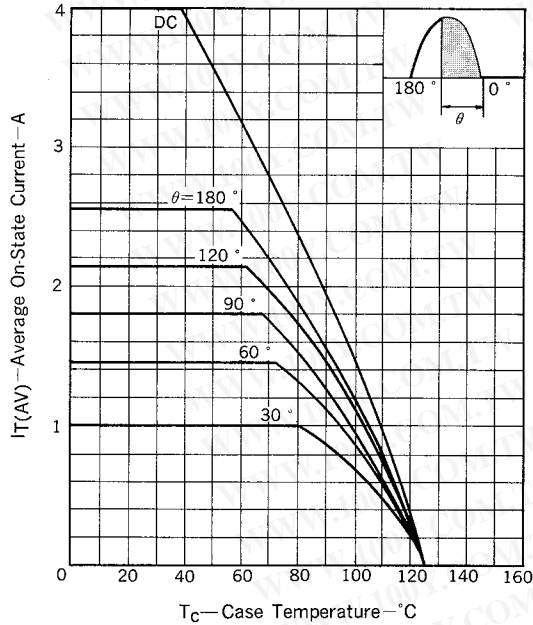

Fig. 4 $T_a-I_{T(AV)}$ RATINGS

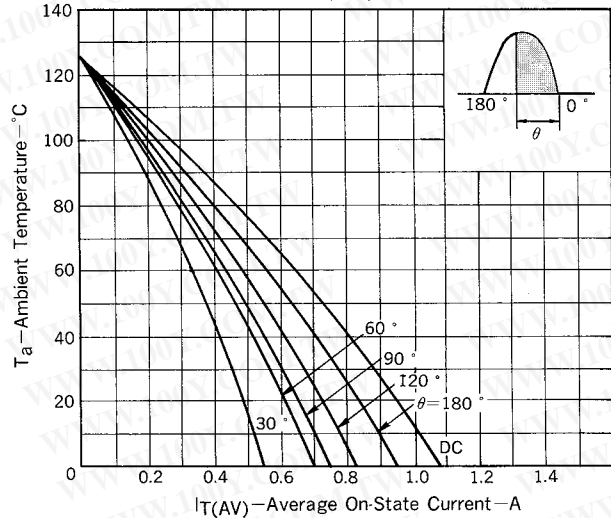

Fig. 5 $I_{GT}-T_a$ TYPICAL DISTRIBUTION

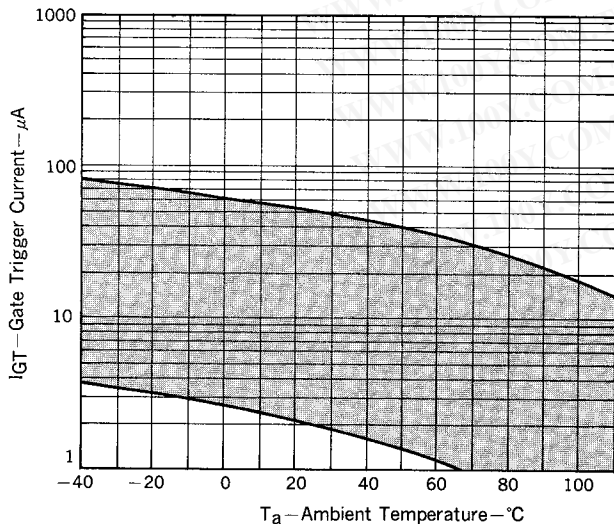

Fig. 6 $V_{GT}-T_a$ TYPICAL DISTRIBUTION

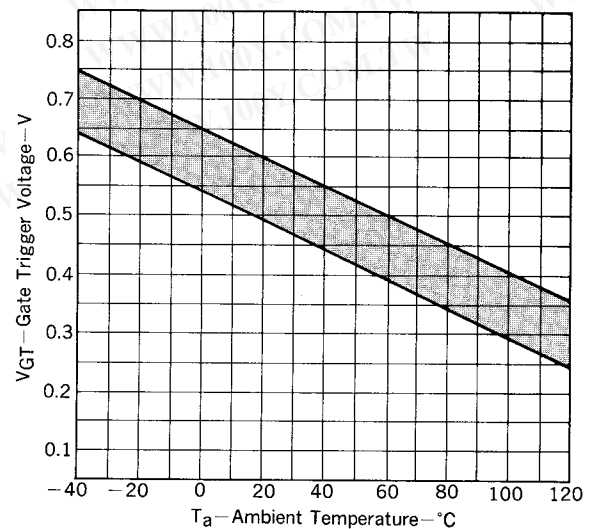

Fig. 7 $I_{GT}-\tau_G$ TYPICAL DISTRIBUTION

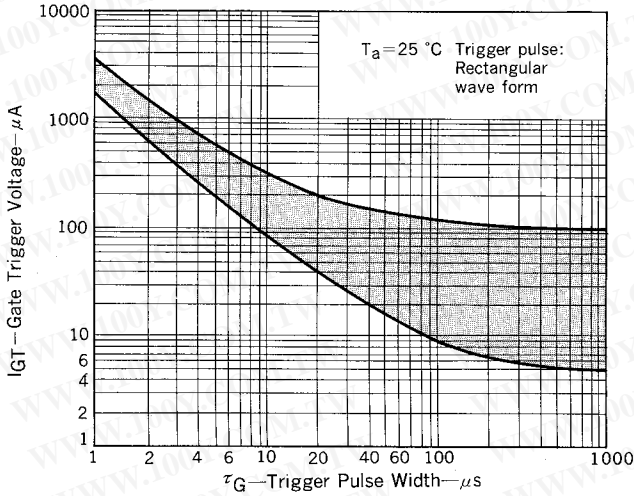

Fig. 8 $V_{GT}-\tau_G$ TYPICAL DISTRIBUTION

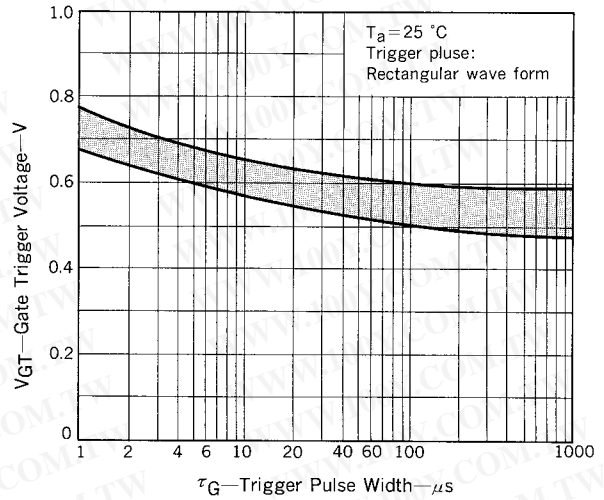

Fig. 9 I_H-T_a TYPICAL DISTRIBUTION

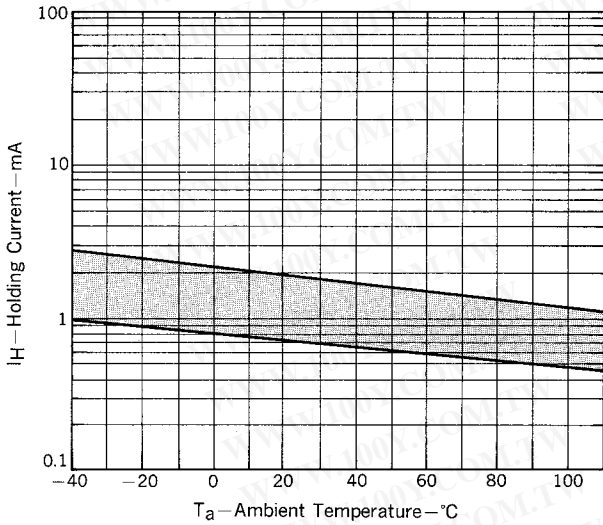

Fig. 10 I_{TSM} RATINGS

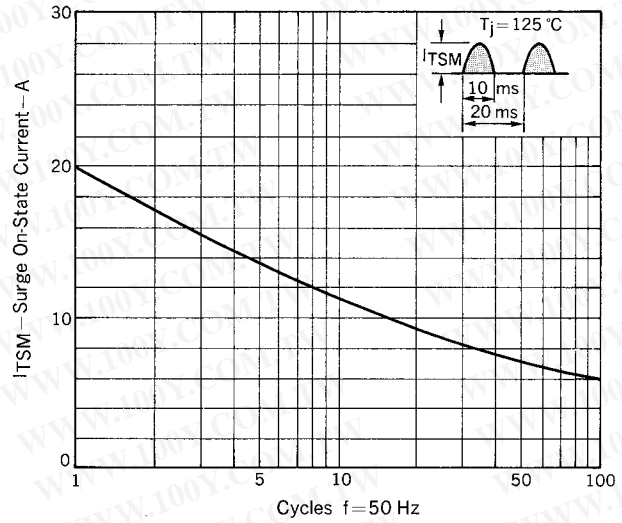
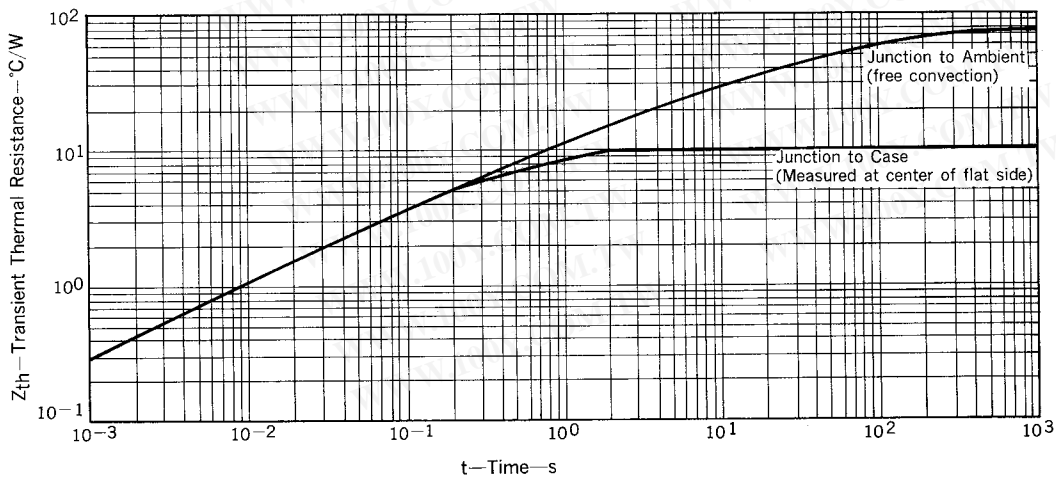

Fig. 11 Z_{th} CHARACTERISTICS



勝特力材料 886-3-5753170
 勝特力电子(上海) 86-21-54151736
 勝特力电子(深圳) 86-755-83298787
[Http://www.100y.com.tw](http://www.100y.com.tw)

NOTICE FOR INSTALLATION

1. Electrode leads (especially heat sink tablet) are not granted to be bent because of wet-proof. However in case it is required inevitably, a mechanical stress should not be put on mold. Fix tightly between the mold case and the area to be formed or bent.
2. Electrode leads should not be bent more than twice over 90°. Avoid the bending within 1.5 mm from the neck of mold case.
3. Special lead and heat tab formings as indicated below are available at an additional cost.

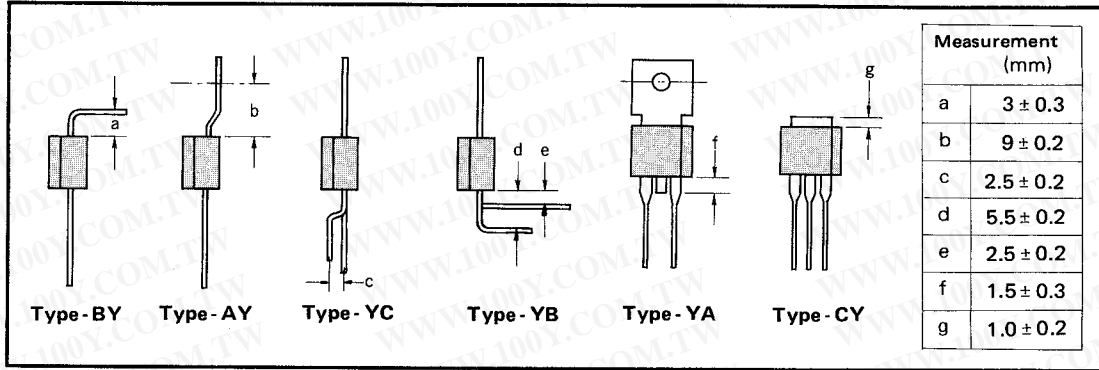

4. The surface of heat sink for thermal radiator is to be smooth without any foreign matter.
5. Suitable torque value is 4 to 5 kg.cm.
6. Soldering
 - Recommended solder: PbSn (4 : 6)
Melting point 180 °C
 - Dimension from the neck of leads to dipping points 4 to 6 mm
 - Soldering temperature and period
 - 250 °C less than 5 s.
 - 230 °C less than 10 s.

REFERENCE

Document name	Document No.
Quality control guide of semiconductor devices	MEI-1202
Assembly manual of semiconductor devices	IEI-1207

[MEMO]

No part of this document may be copied or reproduced in any form or by any means without the prior written consent of NEC Corporation. NEC Corporation assumes no responsibility for any errors which may appear in this document.

NEC Corporation does not assume any liability for infringement of patents, copyrights or other intellectual property rights of third parties by or arising from use of a device described herein or any other liability arising from use of such device. No license, either express, implied or otherwise, is granted under any patents, copyrights or other intellectual property rights of NEC Corporation or others.

The devices listed in this document are not suitable for use in aerospace equipment, submarine cables, nuclear reactor control systems and life support systems. If customers intend to use NEC devices for above applications or they intend to use "Standard" quality grade NEC devices for applications not intended by NEC, please contact our sales people in advance.

Application examples recommended by NEC Corporation

Standard: Computer, Office equipment, Communication equipment, Test and Measurement equipment, Machine tools, Industrial robots, Audio and Visual equipment, Other consumer products, etc.

Special: Automotive and Transportation equipment, Traffic control systems, Antidisaster systems, Anticrime systems, etc.