



### FEATURES

- Carbon resistive element.
- High mechanical endurance.
- Upon request:
  - Detents
  - Stereo matching
  - Switch
  - Nut & washer

**勝特力材料 886-3-5753170**  
**勝特力电子(上海) 86-21-34970699**  
**勝特力电子(深圳) 86-755-83298787**  
[Http://www.100y.com.tw](http://www.100y.com.tw)

### MECHANICAL SPECIFICATIONS

- Mechanical rotation angle:  $310^\circ \pm 5^\circ$
- Electrical rotation angle:  $290^\circ \pm 20^\circ$
- Torque: 0.5 to 1.5 Ncm. (0.7 to 2.1 in-oz)
- Stop torque: > 80 Ncm. (> 112 in-oz)

### ELECTRICAL SPECIFICATIONS

- Range of values (\*)  
 $100\Omega \leq R_n \leq 5\text{ M}$  (Decad. 1.0 - 2.0 - 2.2 - 2.5 - 4.7 - 5.0)
- Tolerance (\*):  $100\Omega \leq R_n \leq 1\text{M}$  .....  $\pm 20\%$   
 $1\text{M}\Omega < R_n \leq 5\text{M}$  .....  $\pm 30\%$
- Max. Voltage: 250 VDC (lin) 150 VDC (no lin)
- Nominal Power 50°C (122°F) (see power rating curve)  
0.25 W (lin) 0.12 W (no lin)
- Taper (\*) (Log. & Alog. only  $R_n > 1\text{K}$ ) Lin ; Log; Alog.
- Residual resistance(\*):  $\leq 0.5\% R_n$  (5  $\Omega$  min)
- Equivalent Noise Resistance:  $\leq 3\% R_n$  (3  $\Omega$  min.)
- Operating temperature\*\*:  $-25^\circ\text{C} + 70^\circ\text{C}$  ( $-13^\circ\text{F} + 158^\circ\text{F}$ )

\* Others upon request

\*\* Up to 85°C depending on application

### HOW TO ORDER

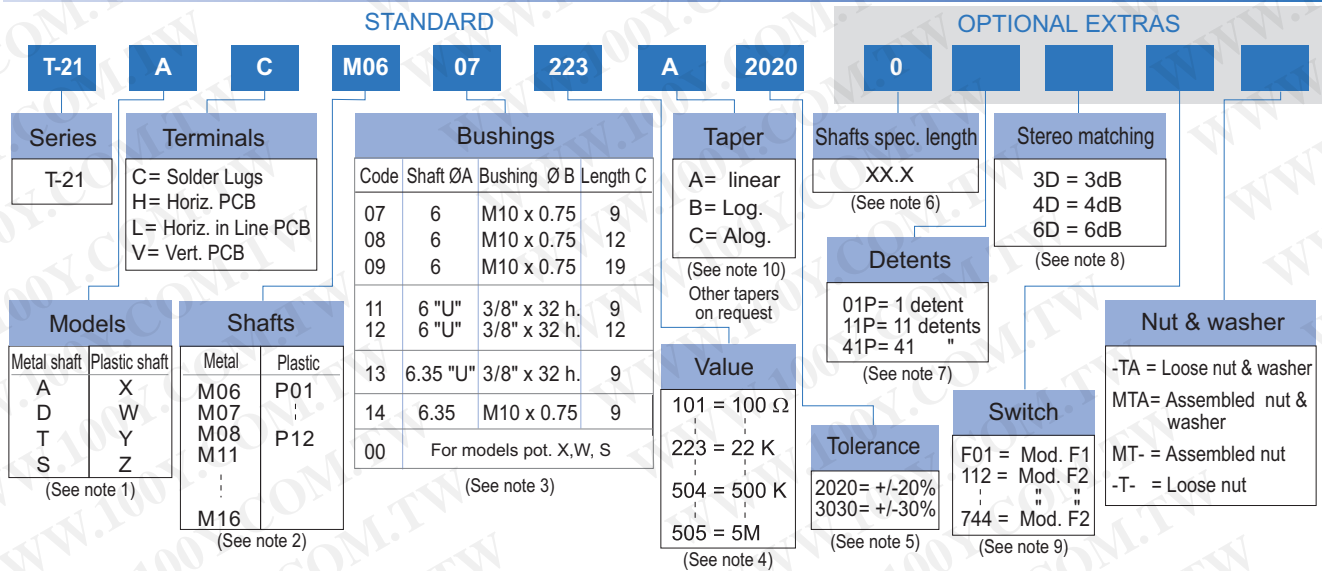

### NOTES:

- MODELS : Models D y T are not available with "V" terminals.
- SHAFTS : The codes indicate diameter and length. M08: Code for the double potentiometer.
- BUSHINGS ; The codes types 11, 12 and 13 have an antirotation lug (at 90°CW). Plastic shaft and double model are only available with Ø6 bushing.
- VALUE:
  - Code:  $\frac{10}{1} = 100\Omega$
  - Number of zeros 2 first digits of the value.
  - In models "D" and "T" with different values, order under special drawing number.
- Tolerance (special), upon request. Example:  $\frac{+7\%}{-5\%}$  Code:  $\frac{07}{05}$ 
  - negative tolerance
  - positive tolerance
- Shafts special length:
  - Only for special length and plain shafts (not knurled). Example: Shaft Ø6 L= 24.5
  - Flatted and slotted shafts, etc. will need drawing.
  - Shaft M08 (T-21D) with other length, order under special drawing number. Recommendation : Shaft L > 60 ..... bushing C = 19
- DETENTS : - Not available in models with plastic shaft X, W, Y, Z.  
- Detents and switch are not compatible.
- Stereo matching: Only available in tandem models and upon request.
- SWITCHES : Two types of switches are offered: F1 and F2.
  - F1 = The code is "F01"  
Plastic shafts are only available if they are code P10, P11 or P12
  - F2 = (Only with metal shaft) Indicate the corresponding I-21 switch code.
- Switch option not available with antilog taper.

NOTE: The information contained here should be used for reference purposes only.

## HOW TO ORDER CUSTOM DRAWING

T-21 A C + DRAWING NUMBER (Max. 16 digits)

This way of ordering should be used for options which are not included in the "How to order" standard and optional extras.

## STANDARD OPTIONS

Shaft length ..... 0 standard  
 Detents ..... Without  
 Stereo matching ..... Only for model "T" and upon request  
 Switch ..... No switch  
 Nut & washer ..... Without nut and washer

## MODELS WITH METALIC SHAFTS

T-21 A

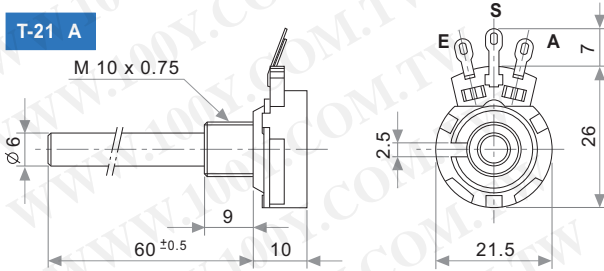

T-21 T

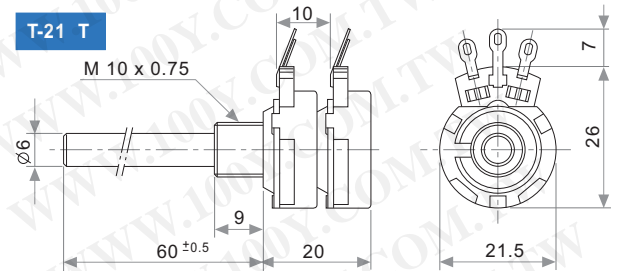

T-21 D

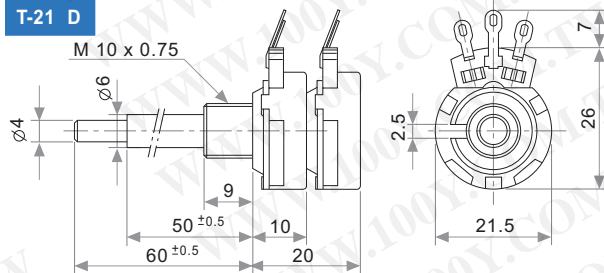

A = Initial  
 S = Wiper  
 E = Final

T-21 S

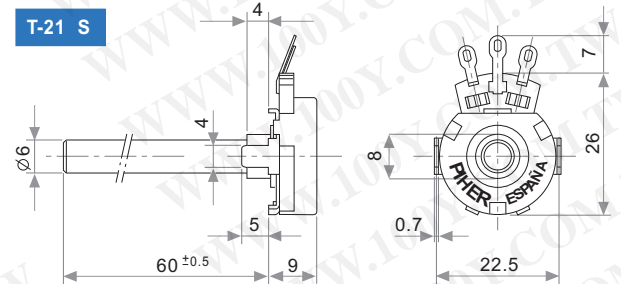

## MODELS WITH PLASTIC SHAFTS

T-21 X

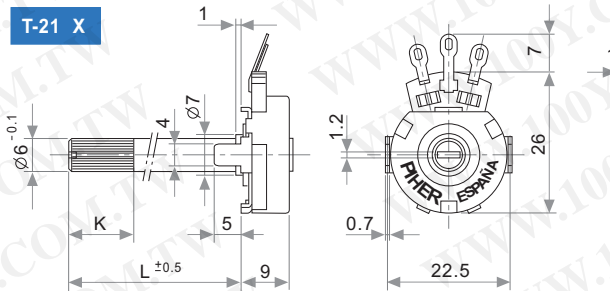

T-21 W

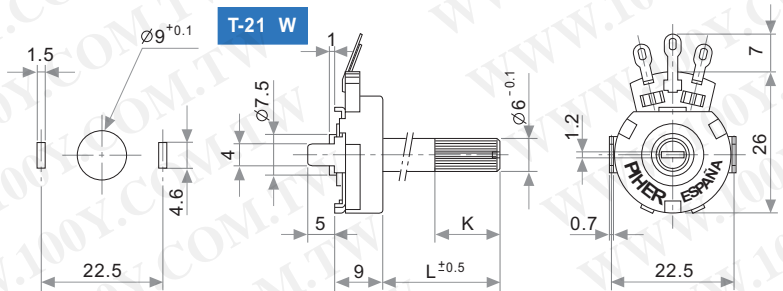

T-21 Y

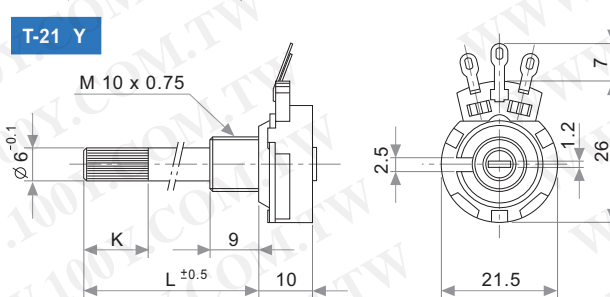

T-21 Z

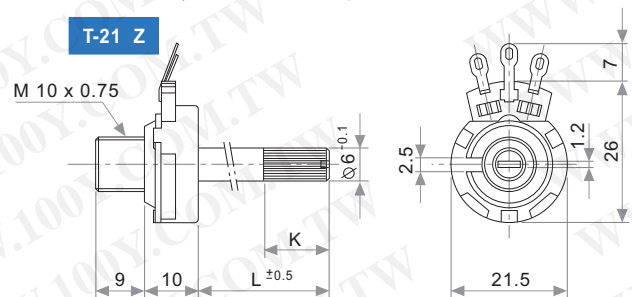

## TERMINALS

T-21 C

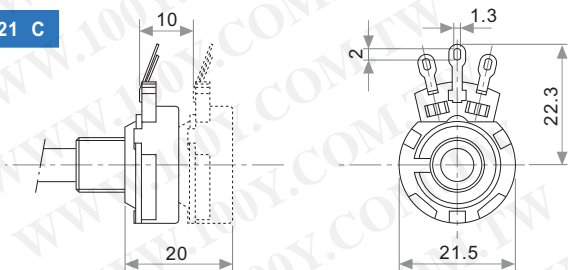

T-21 H

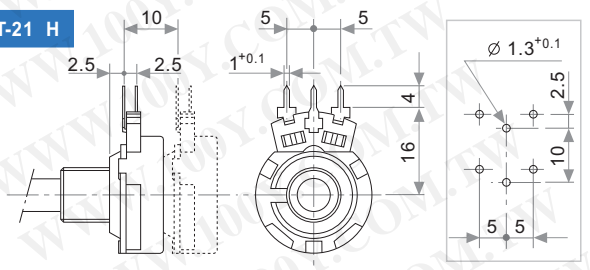

T-21 L

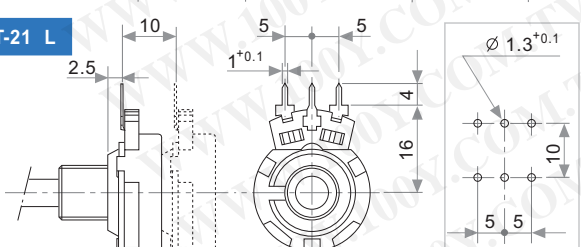

T-21 V

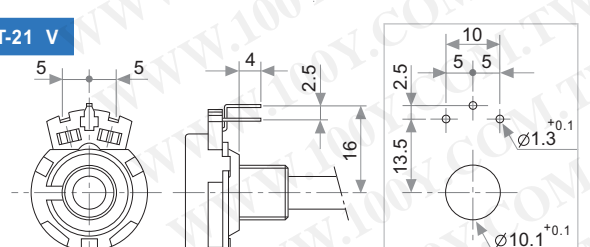

## PLASTIC SHAFTS

T-21 X/Y without Switch			
Knurling length	T-21 X	T-21 Y	CODE
K = 0	L = 2	/	P01
K = 6	L = 10	/	P02
K = 12	L = 16	L = 15	P03
K = 12	L = 26	L = 25	P04
K = 12	L = 36	L = 35	P05
K = 35	L = 46	L = 45	P06

T-21Y w/Sw F01		
Knurling length	T-21 Y	CODE
K = 5	L = 16	P10
K = 14.6	L = 25	P11
K = 35	L = 46	P12

勝特力材料 886-3-5753170  
 勝特力电子(上海) 86-21-34970699  
 勝特力电子(深圳) 86-755-83298787  
[Http://www.100y.com.tw](http://www.100y.com.tw)

T-21 W/Z without Switch			
Knurling length	T-21 W	T-21 Z	CODE
K = 12	L = 26	L = 26	P07
K = 12	L = 36	L = 36	P08
K = 12	L = 46	L = 46	P09

## METALIC SHAFTS

### PLAIN SHAFT

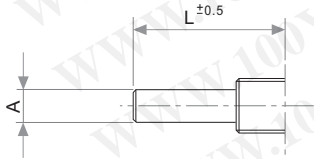

A	L	CODE
4	40	M04
6	60	M06
6.35	60	M07
4/6	50/60	M08

### UNDER DRAWING

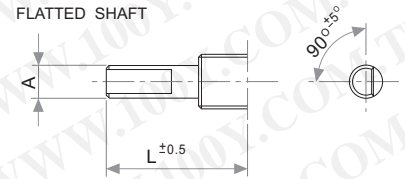

### KNURLED SHAFT

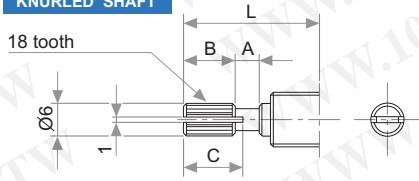

L	A	B	C	CODE
15	2	6	7	M11
20	2	10	11	M12
25	4	12	14	M13
30	4	12	14	M14
35	4	12	14	M15
40	4	12	14	M16

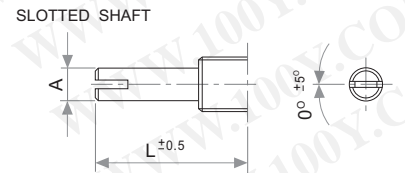

## BUSHINGS

### STANDARD

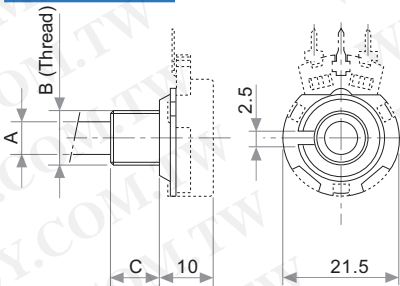

CODE	A	B	C
07	6	M10 x 0.75	9
08	6	M10 x 0.75	12
09	6	M10 x 0.75	19
14	6.35	M10 x 0.75	9

### NON ROTARY PAWL

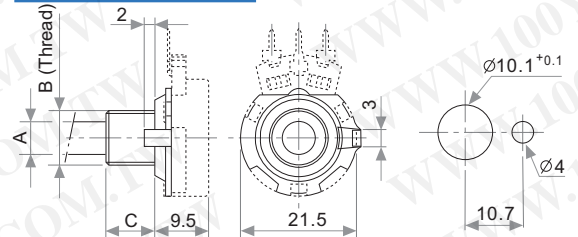

CODE	A	B	C
11	6	3/8" x 32 h.	9
12	6	3/8" x 32 h.	12
13	6.35	3/8" x 32 h.	9

## DETENTS

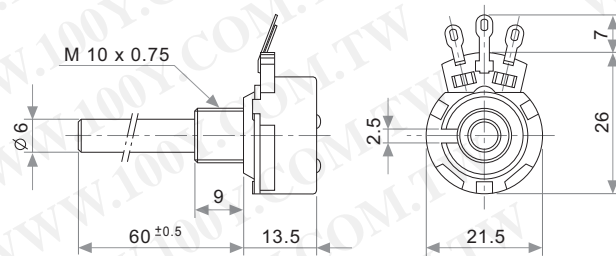

## TAPERS

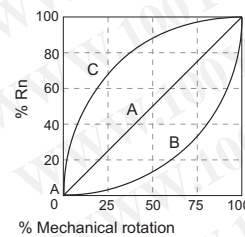

A: Lin.  
 B: Log.  
 C: Alog.

## POWER RATING CURVE

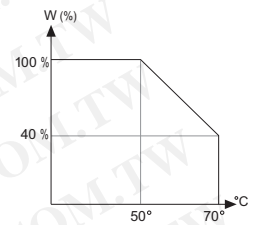

## TESTS

## TYPICAL VARIATIONS

ELECTRICAL LIFE	1.000 h. 50°C; 0.25 W	±5 %
MECHANICAL LIFE* :	25.000 (10-15 CPM)	±3 % (Rn < 1 M)
TEMPERATURE COEFFICIENT	-25°C; +70°C	±300 ppm (Rn < 100 K)
THERMAL CYCLING	16 h. @ 85°C; 2h. @ -25°C	±2.5 %
DAMP HEAT	500 h. 40°C 95% HR	±5 %
VIBRATION (for each plane X,Y,Z)	2 h. @ 10 Hz - 55 Hz.	±2 %

NOTE: Out of range values may not comply these results.

(\* ) only applicable to values ≥1K. For lower values please consult.

## PACKAGING

Boxes of 150 / 200 pieces (160 x 110 x 85 mm.)



## SWITCH F1

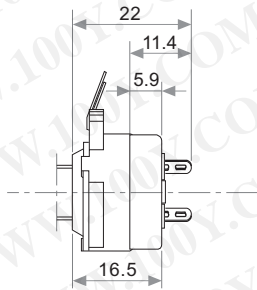

MECHANICAL & ELECTRICAL SPECIFICATIONS	F 1
OPERATING ANGLE	50° ±5°
OPERATING TORQUE	3-7 Ncm (4.2-9.8 in-oz)
MAXIMUM AXIAL CHARGE	80 N; 17 pounds
NOMINAL CURRENT	1A; 250 VAC
CONTACT RESISTANCE	≤ 25mΩ
TEST VOLTAGE (DIELECTRIC STRENGTH)	2000 V (50 Hz)

## SWITCH F2

ELECTRICAL SPECIFICATIONS	F 2
SWITCH RATING	2 or 4A; 250 VAC
CONTACT RESISTANCE	≤ 25 mΩ
DIELECTRIC STRENGTH	2000 V
INSULATION RESISTANCE	100 MΩ
MECHANICAL SPECIFICATIONS	F 2
OPERATING ANGLE (ROTARY)	35° ± 5°
PUSH / PUSH OPERATING TRAVEL	4 mm.
PUSH / PULL OPERATING TRAVEL	2.5 mm.
OPERATING TORQUE (ROTARY)	2 to 9 Ncm. (2.8 to 12.7 oz/in)
OPERATING FORCE (Push/Push ; Push/Pull)	4 to 7 N (14 to 27 oz)
MECHANICAL LIFE	10.000 cycles
STOP TORQUE	> 100 Ncm. (142 oz/in)

### ROTARY

### PUSH

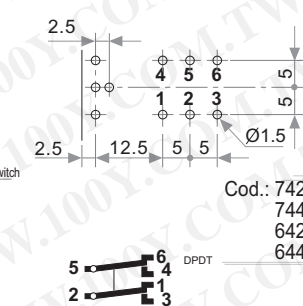
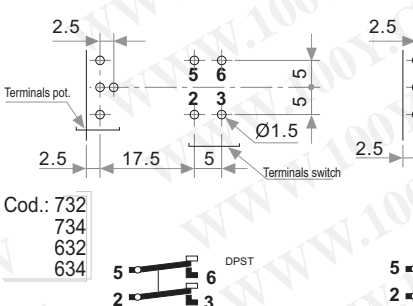
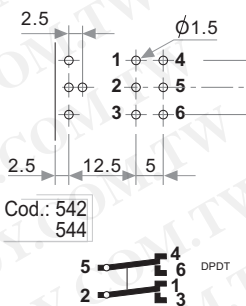
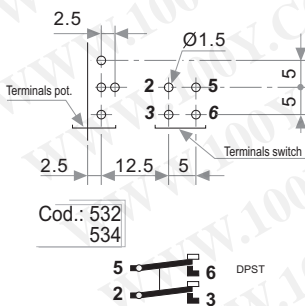
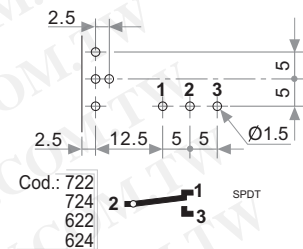
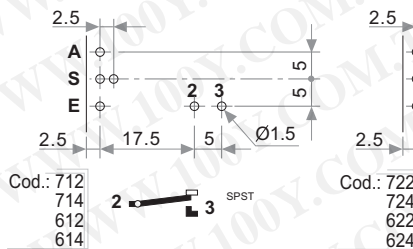
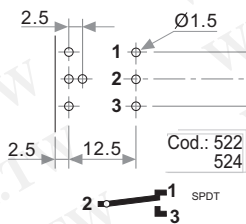
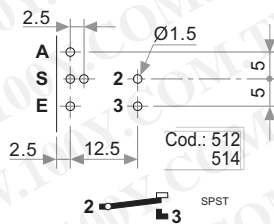
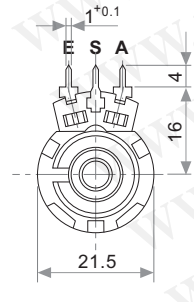
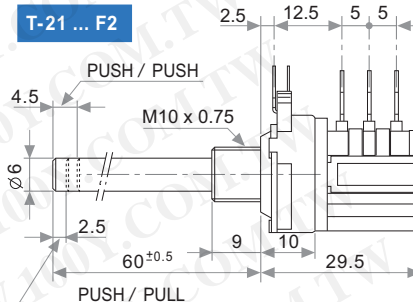
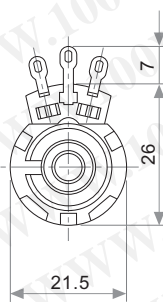
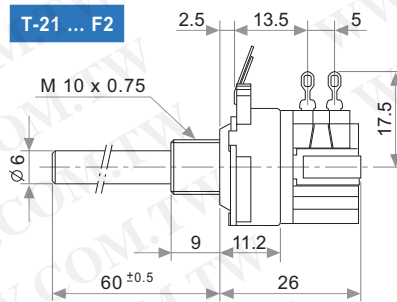

**I-21 HOW TO ORDER** (only switch)

**STANDARD**

**OPTIONAL**

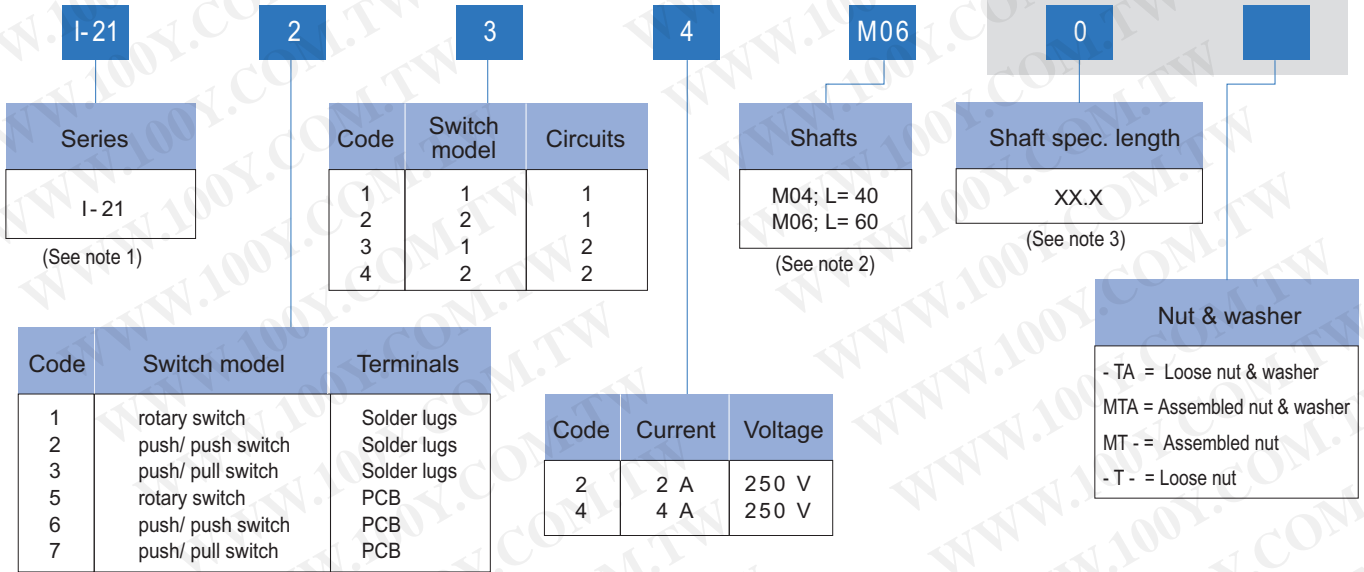

**NOTES:**

- (1) When only the switch is ordered (without potentiometer), it will be called "I-21" followed by the respective code.
- (2) The shaft and bushing for "I-21" is:

COD.	A	B	L
M06	6	M10 x 0.75	60

- (3) Only for special length and plain shaft (not knurled).  
 Example: E: Ø6 L= 24.5 M06 24.5 → special length  
 Flatted and slotted shafts, etc. will need drawing.

**HOW TO ORDER CUSTOM DRAWING**

**STANDARD OPTIONS**

I-21 + DRAWING NUMBER (Max. 16 digits)

This way of ordering should be used for options which are not included in the "How to order" standard and optional extras.

Shaft length ..... See note 2  
 Nut & washer ..... Without nut and washer

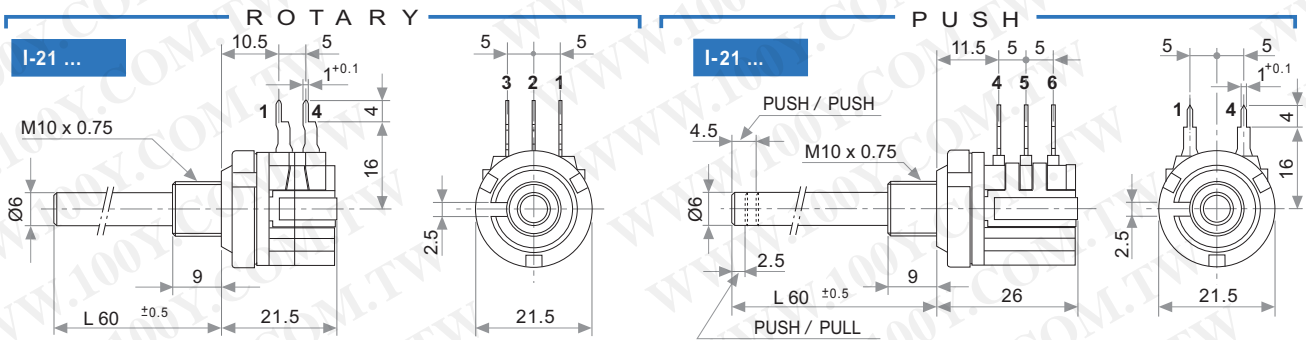

**NUT & WASHER**

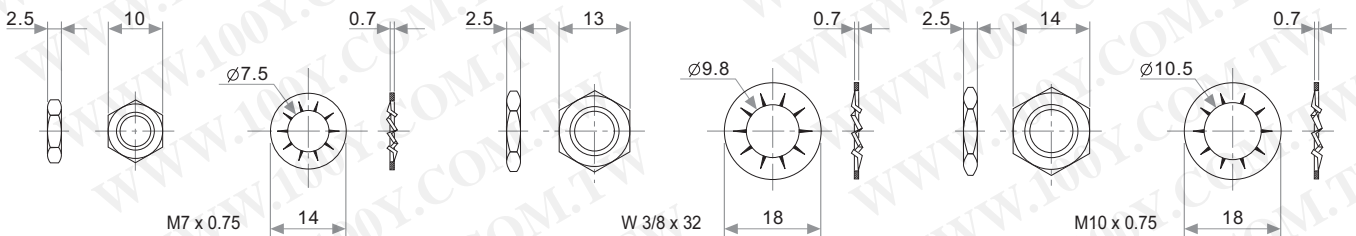

**PACKAGING**

Boxes of 100 pieces ( 160 x 110 x 85 mm.).