

勝特力材料 886-3-5753170
 勝特力电子(上海) 86-21-34970699
 勝特力电子(深圳) 86-755-83298787
[Http://www.100y.com.tw](http://www.100y.com.tw)

1.0 Scope:

This sheet is the statement of the Lead-Free Chip Resistor Array-convex Terminal specification that UNIOHM'S productions can meet.

2.0 Type Designation:

The type designation shall be in the following from:

Example

Type	Power rating	Resistance tolerance	Nominal resistance
4D03	1/16W	F	22KΩ

3.0 Ratings & Dimension:

Dimension: mm

<p style="text-align: center;">2D02</p>	<p style="text-align: center;">2D03</p>
<p style="text-align: center;">4D02</p>	<p style="text-align: center;">4D03(4DP3)</p>
<p style="text-align: center;">16P8</p>	

Type	2D02	4D02	2D03	4D03	4DP3	16P8
Power Rating at 70°C	1/16W	1/16W	1/16W	1/16W	1/10W	1/16W
Max Working Voltage	50V	50V	50V	50V	50V	50V
Max Overload Voltage	100V	100V	100V	100V	100V	100V
Dielectric Withstanding Voltage	100V	100V	100V	300V	300V	300V
±1%	10Ω-1MΩ	10Ω-1MΩ	10Ω-1MΩ	1Ω-1MΩ	1Ω-1MΩ	1Ω-1MΩ
±5%	10Ω-1MΩ	10Ω-1MΩ	10Ω-1MΩ	1Ω-1MΩ	1Ω-1MΩ	1Ω-1MΩ
Operating Temperature	-55 ~ +155°C					

4.0 Structure:

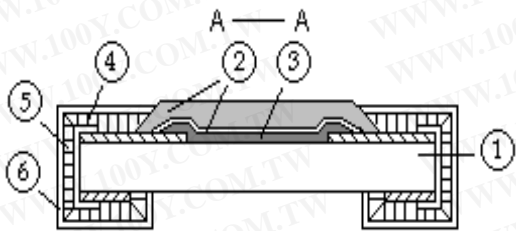

- 1: High purity alumina substrate 高纯度氧化铝基板
- 2: Protective covering 保护层
- 3: Resistive covering (Ag for 0Ω) 电阻层(0Ω 爲层)
- 4: Termination (inner) Ni/Cr 端面(内)镍/铬
- 5: Termination (between) Ni plating
- 6: Termination (outer) Sn plating

5.0 Marking:

(1) Normal for 2D02 sizes, no marking on the body. 0Ω resistors is no marking too

EXAMPLE:

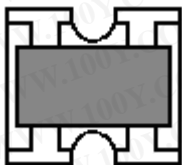

(2) ±5% Tolerance of 4D02, 2D03, 4D03, 4DP3 and 16P8 size: the first two digits are significant figures of resistance and the third denotes number of zeros following

EXAMPLE:

2D03

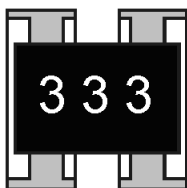

33000 → 33KΩ

4D02, 4D03, 4DP3

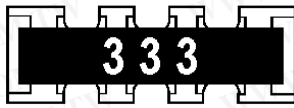

33000 → 33KΩ

16P8

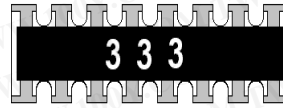

33000 → 33KΩ

(3) ±1% Tolerance of 4D02, 2D03, 4D03, 4DP3 and 16P8 size: first three digits are significant figures of resistance and the fourth denotes number of zeros following

EXAMPLE:

2D03

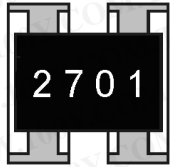

2701 → 2.7KΩ

4D02, 4D03

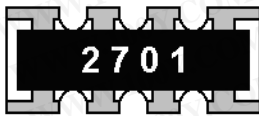

2701 → 2.7KΩ

16P8



2701 → 2.7KΩ

6.0 Power Rating:

Resistors shall have a power rating based on continuous load operation at an ambient temperature from -55°C to 70°C. For temperature in excess of 70°C, the load shall be derate as shown in figure 1

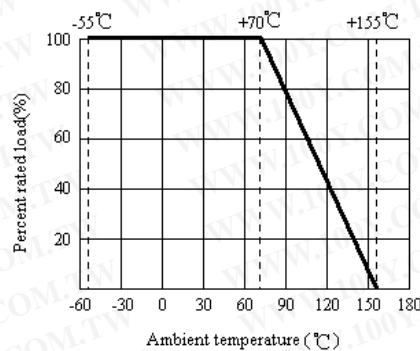

6.1 Voltage rating:

Resistors shall have a rated direct-current (DC) continuous working

voltage or an approximate sine-wave root-mean-square (RMS) alternating-current (AC) continuous working voltage at commercial-line frequency and waveform corresponding to the power rating, as determined from the following formula:

$$RCWV = \sqrt{P \times R}$$

Where: RCWV commercial-line frequency and waveform (Volt.)

P = power rating (WATT.)

R = nominal resistance (OHM)

The overload voltage is 2.5 times RCWV or Max. Overload voltage whichever is less.

In no case shall the rated DC or RMS AC continuous working voltage be greater than the applicable maximum value.

The overload voltage is 2.5 times RCWV or Max. Overload voltage whichever is less.

7.0 Performance Specification:

Characteristic	Limits		Test Method (JIS-C-5201&5202)
Temperature Coefficient	2D02 4D02 2D03	$\pm 200 \text{ PPM}/^\circ\text{C}$	4.8 natural resistance changes per temp. Degree centigrade $\frac{R_2 - R_1}{R_1(T_2 - T_1)} \times 10^6 \text{ (PPM}/^\circ\text{C)}$ R ₁ : resistance value at room temp. (T ₁) R ₂ : resistance value at room temp. +100°C (T ₂) Test pattern: room temp. (T ₁), room temp. +100°C (T ₂)
	4D03 4DP3 16P8	$\geq 10 \Omega$: $\pm 200 \text{ PPM}/^\circ\text{C}$ $< 10 \Omega$: $\pm 400 \text{ PPM}/^\circ\text{C}$	
Short-time overload	$\pm(2\% + 0.1 \Omega)$ MAX		4.13 Permanent resistance change after the application of a potential of 2.5 times RCWV of Max. Overload Voltage whichever less for 5 seconds.
Insulation resistance	1,000 M Ω or more		4.6 the measuring voltage shall be measured with a direct voltage of (100 \pm 15)v or a voltage equal to the dielectric withstanding voltage., and apply for 1min
Terminal bending	$\pm(1\% + 0.05 \Omega)$ Max		4.33 Twist of test board: Y/x = 3/90 mm for 60Seconds
Dielectric withstanding voltage	No evidence of flashover mechanical damage, arcing or insulation breaks down.		4.7 Resistors shall be clamped in the trough of a 90°C metallic v-block and shall be tested at ac potential respectively specified in the given list of each product type for 60-70 seconds.
Soldering heat	Resistance change rate must be in $\pm(1\% + 0.05 \Omega)$ Max		4.18 Dip the resistor into a solder bath having a temperature of 260°C \pm 5°C and hold it for 10 \pm 1 seconds.

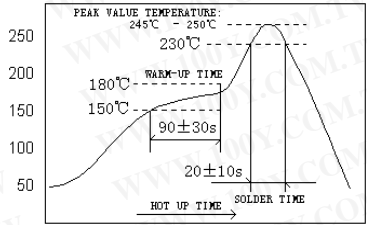
Solderability	95% coverage Min.	Wave solder: Test temperature of solder: 245°C±3°C dipping time in solder: 2-3 seconds.															
	Go up tin rate bigger than half of end pole	Reflow: 															
Temperature cycling	±(1.0%+0.05 Ω) Max	4.19 Resistance change after continuous five cycles for duty cycle specified below: <table border="1" data-bbox="813 918 1420 1120"> <thead> <tr> <th>STEP</th> <th>TEMPERATURE</th> <th>TIME</th> </tr> </thead> <tbody> <tr> <td>1</td> <td>-55°C±3°C</td> <td>30 MINS</td> </tr> <tr> <td>2</td> <td>ROOM TEMP.</td> <td>10 --- 15 MINS</td> </tr> <tr> <td>3</td> <td>+155°C±2°C</td> <td>30 MINS</td> </tr> <tr> <td>4</td> <td>ROOM TEMP.</td> <td>10 --- 15 MINS</td> </tr> </tbody> </table>	STEP	TEMPERATURE	TIME	1	-55°C±3°C	30 MINS	2	ROOM TEMP.	10 --- 15 MINS	3	+155°C±2°C	30 MINS	4	ROOM TEMP.	10 --- 15 MINS
STEP	TEMPERATURE	TIME															
1	-55°C±3°C	30 MINS															
2	ROOM TEMP.	10 --- 15 MINS															
3	+155°C±2°C	30 MINS															
4	ROOM TEMP.	10 --- 15 MINS															
Load life in humidity	±(3%+0.1Ω)MAX.	7.9 Resistance change after 1,000 hours (1.5 hours "ON", 0.5 hour "OFF") at RCWV in a humidity chamber controlled at 40°C±2°C and 90 to 95% relative humidity.															
Load life	±(3%+0.1Ω)Max	4.25.1 Permanent resistance change after 1,000 hours operating at RCWV with duty cycle 1.5 hours "ON", 0.5 hour "OFF" at 70°C±2°C ambient.															

8.0 Explanation of Part No. System:

The standard Part No. includes 14 digits with the following explanation:

8.1 This is to indicate the Chip Array Resistor size.

Example: 2D02, 4D02, 2D03, 4D03, 4DP3, 16P8

8.2 5th~6th digits:

8.2.1 This is to indicate the wattage or power rating. To dieting the size and the numbers,

The following codes are used; and please refer to the following chart for detail:

W=Normal Size; "1" ~ "G" to denotes "1" ~ "16" as Hexadecimal:

1/16W~1W:

Approved	Checked	Prepared	File NO.	Edition	Date	Page
William Zhao	Apple Liu	Shuhua Zeng	CS-01-031	1	2015.06.19	8/12

Wattage	1/2	1/3	1/4	1/5	1/6	1/8	1/10	1/16	1
Normal Size	W2	W3	W4	W5	W6	W8	WA	WG	1W

8.2.2 For power rating less than 1 watt, the 5th digit will be the letters W or S to represent the size required & the 6th digit will be a number or a letter code.

Example: WG=1/16W WA=1/10W

8.3 The 7th digit is to denote the Resistance Tolerance. The following letter code is to be used for indicating the standard Resistance Tolerance.

F=±1% G=±2% J=±5% K= ±10%

8.4 The 8th to 11th digits is to denote the Resistance Value.

8.4.1 For the standard resistance values of E-24 series in 5%&10% tolerance, the 8th digit is "0" ,the 9th & 10th digits are to denote the significant figures of the resistance and the 11th digit is the number of zeros following;

For the standard resistance values of E-96 series in ≤2% tolerance, the 8th digit to the 10th digits is to denote the significant figures of the resistance and the 11th digit is the zeros following.

8.4.2 The following number s and the letter codes are to be used to indicate the number of zeros in the 11th digit:

0=10⁰ 1=10¹ 2=10² 3=10³ 4=10⁴ 5=10⁵
6=10⁶ J=10⁻¹ K=10⁻² L=10⁻³ M=10⁻⁴

8.4.3 The 12th, 13th & 14th digits.

The 12th digit is to denote the Packaging Type with the following codes:

C=Bulk in (Chip Product) T=Tape/Reel

8.4.4 The 13th digit is normally to indicate the Packing Quantity of Tape/Box & Tape/Reel packaging types. The following letter code is to be used for some packing quantities:

4=4000pcs 5=5000pcs C=10000pcs D=20000pcs

8.4.5 For some items, the 14th digit alone can use to denote special features of additional information with the following codes:

"*" = the internal series general character (usually shown with A, B, C etc.)

9.0 Ordering Procedure: (Example: 4D02 1/16W ±1% 22KΩ T/R-10000)

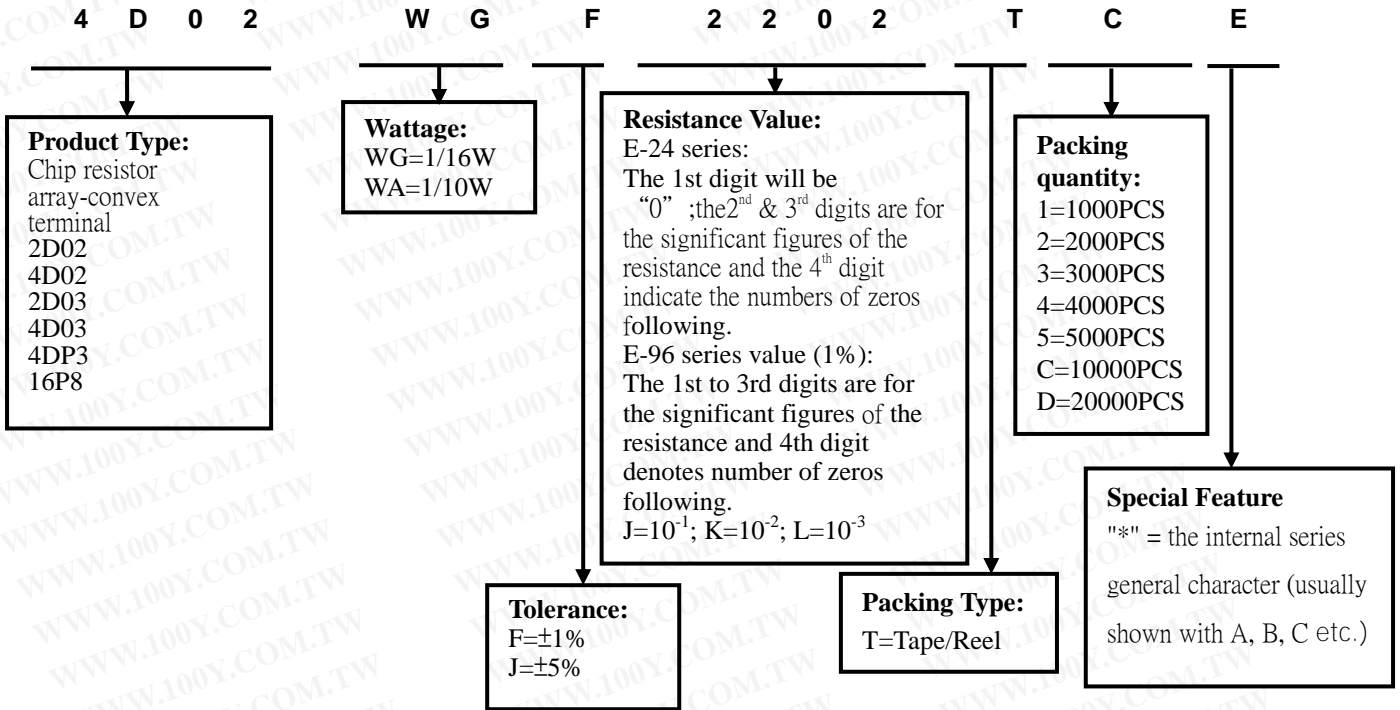

10.0 Packaging:

10.1 Tapping Dimension:

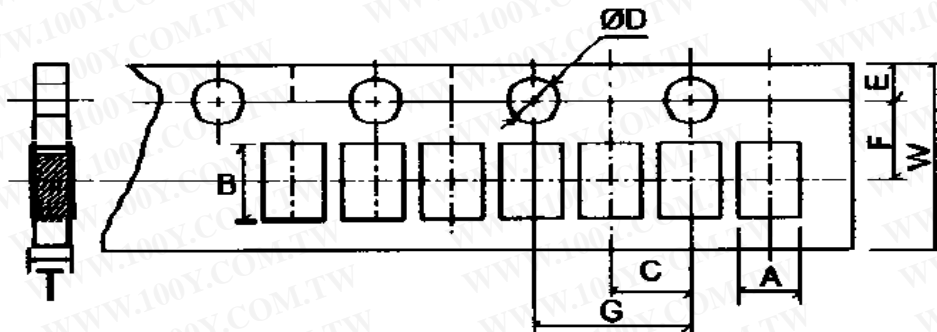

Unit: mm

TYPE	A ±0.2	B ±0.2	C±0.05	+0.1 -0	E±0.1	F±0.05	G±0.1	W±0.2	T±0.1
2D02	1.2	1.2	2.0	1.5	1.75	3.5	4.0	8.0	0.45
4D02	1.2	2.2	2.0	1.5	1.75	3.5	4.0	8.0	0.70

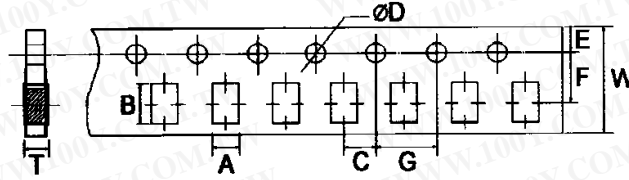

Unit: mm

TYPE	A ±0.2	B ±0.2	C±0.05	ΦD +0.1 -0	E±0.1	F±0.05	G±0.1	W±0.2	T±0.1
2D03	1.9	1.9	2.0	1.5	1.75	3.5	4.0	8.0	0.83
4D03	2.0	3.60	2.0	1.5	1.75	3.5	4.0	8.0	0.83
4DP3	2.0	3.60	2.0	1.5	1.75	3.5	4.0	8.0	0.83
16P8	1.80	4.30	2.0	1.5	1.75	5.5	4.0	12.0	0.75

10.2 Dimension:

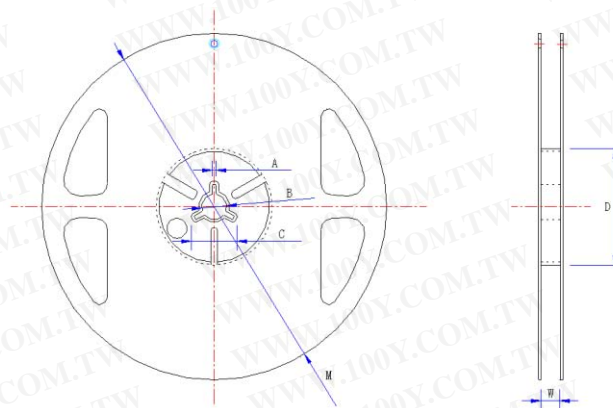

Unit: mm

TYPE	QUANTITY PER REEL	A ± 0.5	B ± 0.5	C ± 0.5	D ± 1.0	M ± 2.0	W ± 1.0
2D02	10,000PCS	2.0	13.0	21.0	60.0	178.0	10.0
4D02	10,000PCS	2.0	13.0	21.0	60.0	178.0	10.0
2D03	5,000PCS	2.0	13.0	21.0	60.0	178.0	10.0
4D03	5,000PCS	2.0	13.0	21.0	60.0	178.0	10.0
4DP3	5,000PCS	2.0	13.0	21.0	60.0	178.0	10.0
16P8	4,000PCS	2.0	13.0	21.0	60.0	178.0	13.8

11.0 Precaution for storage/Transportation:

11.1 UNIOHM recommend the storage condition temperature: 15°C~35°C, humidity :25%~75% (Put condition for individual product)

Even under UNIOHM recommended storage condition, solderability of products over 1 year old (Put condition for each product) may be degraded.

11.2 Store / transport cartons in the correct direction, which is indicated on a carton as a symbol.

Otherwise bent leads may occur due to excessive stress applied when dropping of a carton.

11.3 Product performance and soldered connections may deteriorate if the products are stored in the following places:

- a. Storage in high Electrostatic
- b. Storage in direct sunshine 、rain and snow or condensation
- c. Where the products are exposed to sea winds or corrosive gases, including Cl₂, H₂S, NH₃, SO₂, NO₂.

勝特力材料 886-3-5753170
勝特力电子(上海) 86-21-34970699
勝特力电子(深圳) 86-755-83298787
[Http://www.100y.com.tw](http://www.100y.com.tw)