

V_{RRM}	=	200 V
I_{FAVM}	=	7110 A
I_{FRMS}	=	11200 A
I_{FSM}	=	55000 A
V_{F0}	=	0.74 V
r_F	=	0.026 mW

Rectifier Diode

5SDD 71B0200

Doc. No. 5SYA1132-02 July 06

- Optimized for high current rectifiers
- Very low on-state voltage
- Very low thermal resistance

勝特力材料 886-3-5753170
 勝特力电子(上海) 86-21-34970699
 勝特力电子(深圳) 86-755-83298787
[Http://www.100y.com.tw](http://www.100y.com.tw)

Blocking

V_{RRM}	Repetitive peak reverse voltage	200 V	Half sine wave, $t_p = 10$ ms, $f = 50$ Hz
V_{RSM}	Maximum peak reverse voltage	300 V	Half sine wave, $t_p = 10$ ms
I_{RRM}	Repetitive peak reverse current	≤ 50 mA	$T_j = 170$ °C $V_R = V_{RRM}$

Mechanical

F_M	Mounting force	min.	20 kN
		max.	24 kN
a	Acceleration:	Device unclamped	50 m/s ²
		Device clamped	200 m/s ²
m	Weight		0.14 kg
D_S	Surface creepage distance		4 mm
D_a	Air strike distance		4 mm

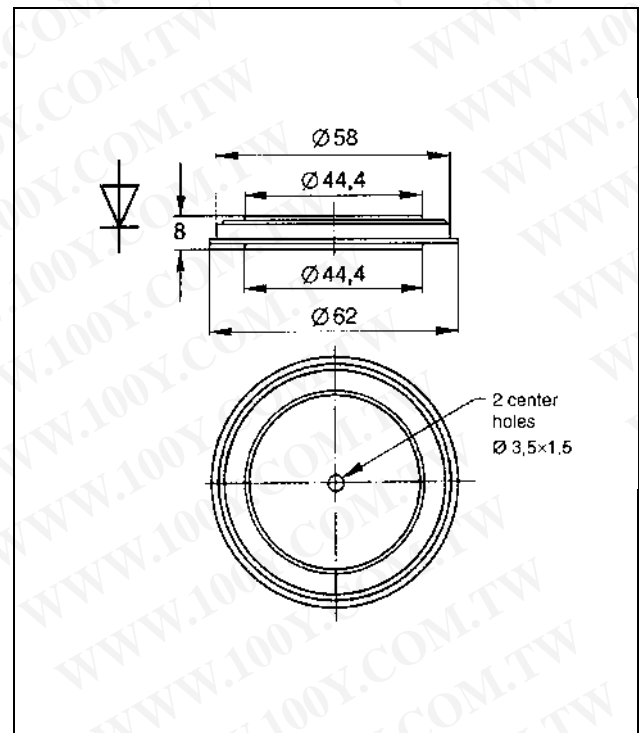

Fig. 1

Outline drawing.

All dimensions are in millimeters and represent nominal values unless stated otherwise.

ABB Switzerland Ltd, Semiconductors reserves the right to change specifications without notice.

ABB

On-state

I_{FAVM}	Max. average on-state current	7110 A	Half sine wave, $T_c = 85\text{ }^\circ\text{C}$	
I_{FRMS}	Max. RMS on-state current	11200 A		
I_{FSM}	Max. peak non-repetitive surge current	55000 A	$t_p = 10\text{ ms}$	Before surge
		60000 A	$t_p = 8.3\text{ ms}$	$T_j = 170\text{ }^\circ\text{C}$
$\int i^2 dt$	Max. surge current integral	15100 kA^2s	$t_p = 10\text{ ms}$	After surge: $V_R \approx 0\text{V}$
		15000 kA^2s	$t_p = 8.3\text{ ms}$	
$V_{F\text{ max}}$	Maximum on-state voltage	$\leq 1.05\text{ V}$	$I_F = 5000\text{ A}$	$T_j = 25\text{ }^\circ\text{C}$
V_{F0}	Threshold voltage	0.74 V	Approximation for $T_j = 170\text{ }^\circ\text{C}$	
r_F	Slope resistance	0.026 $\text{m}\Omega$	$I_F = 5 - 15\text{ kA}$	

Thermal characteristics

T_j	Operating junction temperature range	-40...170 $^\circ\text{C}$		
T_{stg}	Storage temperature range	-40...170 $^\circ\text{C}$		
$R_{th(j-c)}$	Thermal resistance junction to case	$\leq 20\text{ K/kW}$	Anode side cooled	$F_M = 20...24\text{ kN}$
		$\leq 20\text{ K/kW}$	Cathode side cooled	
		$\leq 10\text{ K/kW}$	Double side cooled	
$R_{th(c-h)}$	Thermal resistance case to heatsink	$\leq 10\text{ K/kW}$	Single side cooled	
		$\leq 5\text{ K/kW}$	Double side cooled	

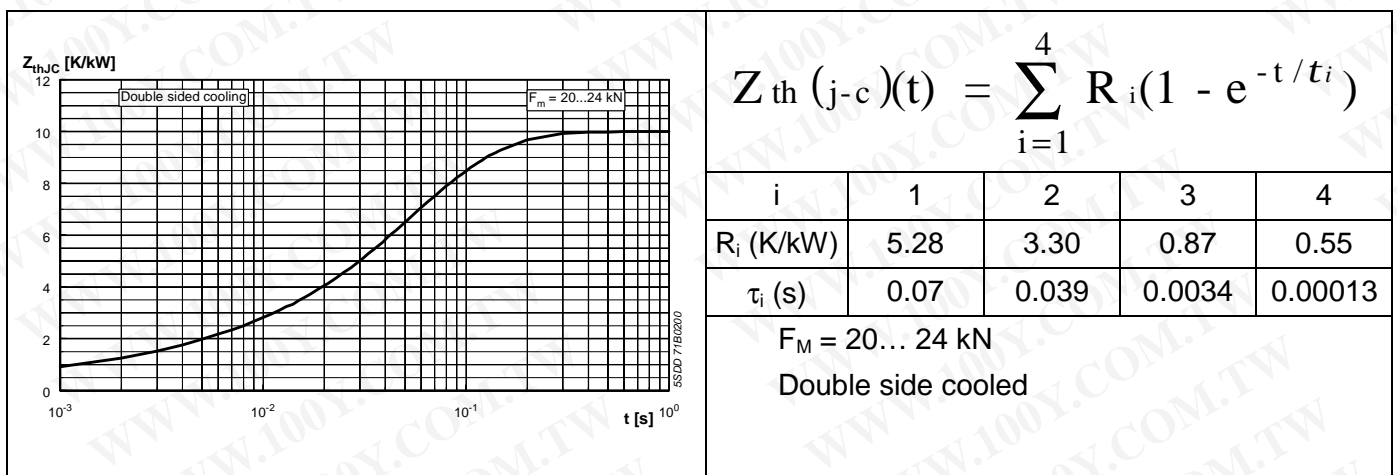

Fig. 2 Transient thermal impedance (junction-to-case) vs. time in analytical and graphical forms.

On-state characteristics

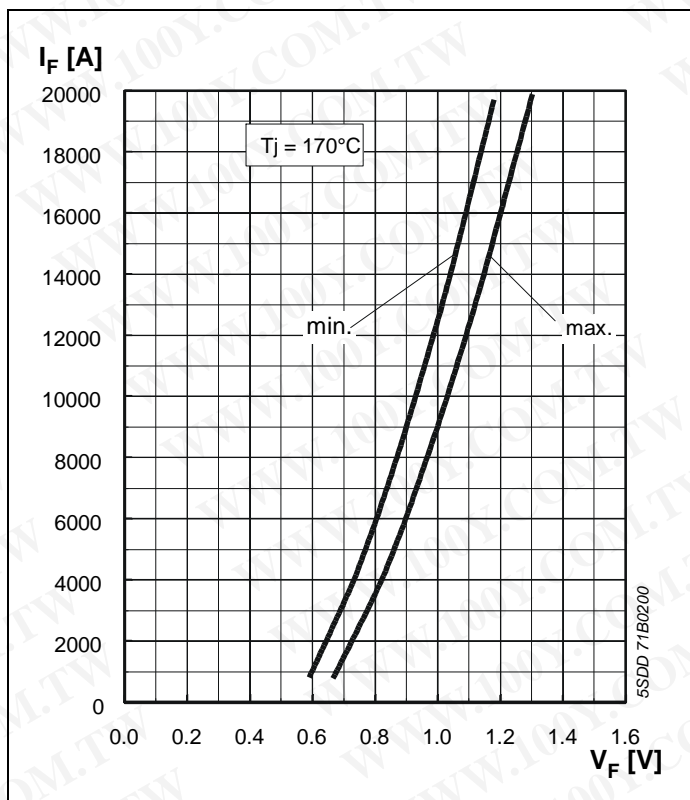

Fig. 3 Forward current vs. forward voltage (min. and max. values).

Surge current characteristics

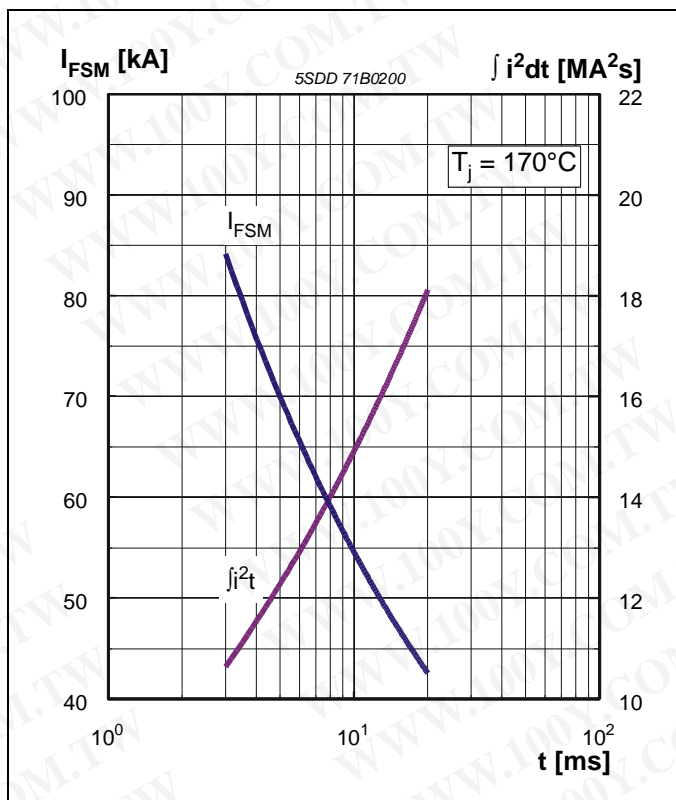

Fig. 4 Surge current and fusing integral vs. pulse width (max. values) for non-repetitive, half-sinusoidal surge current pulses.

Current load capability

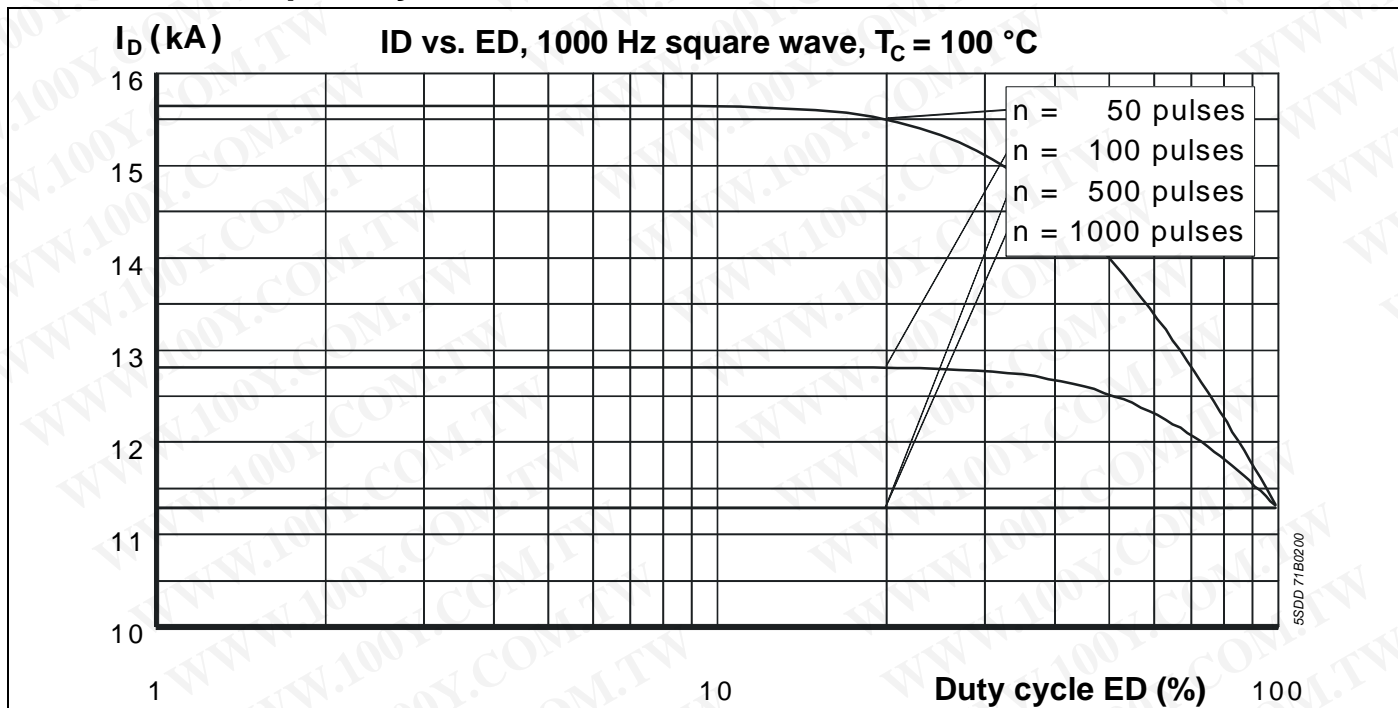

Fig. 5 DC-output current with single-phase centre tap

Current load capacity, cont.

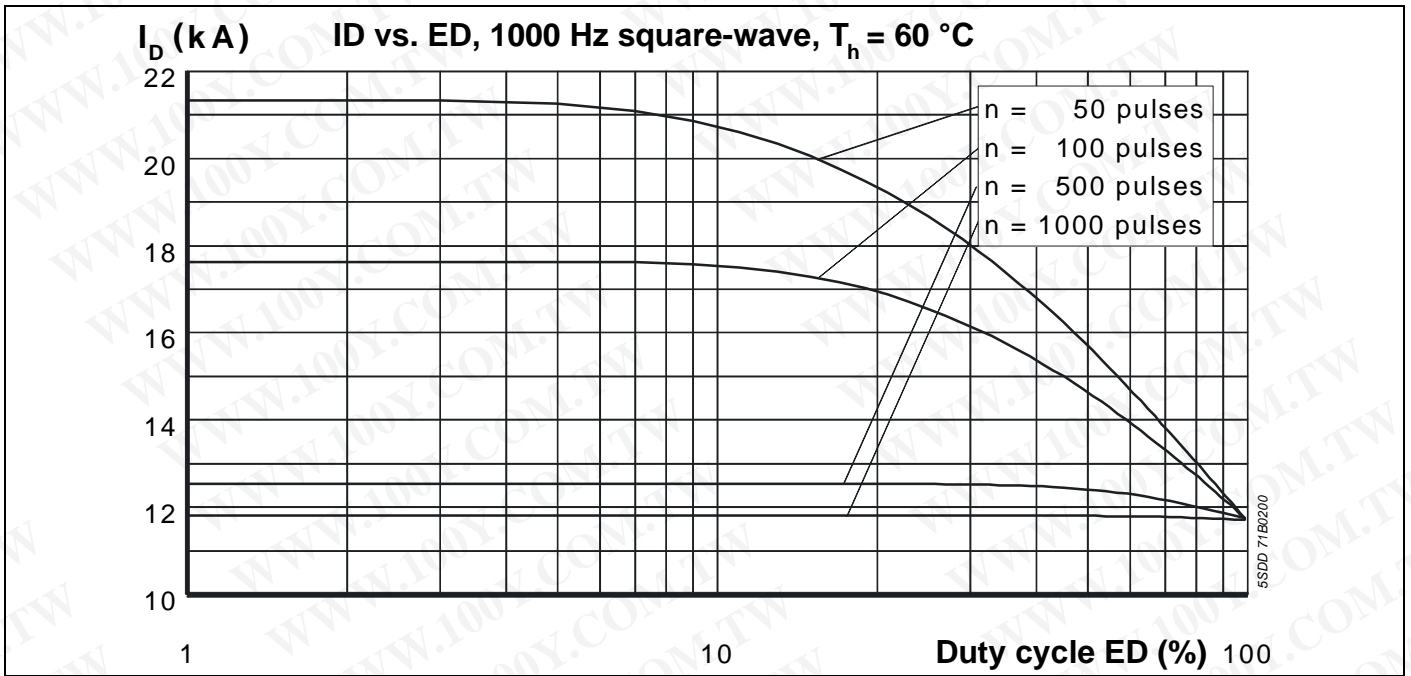

Fig. 6 DC-output current with single-phase centre tap

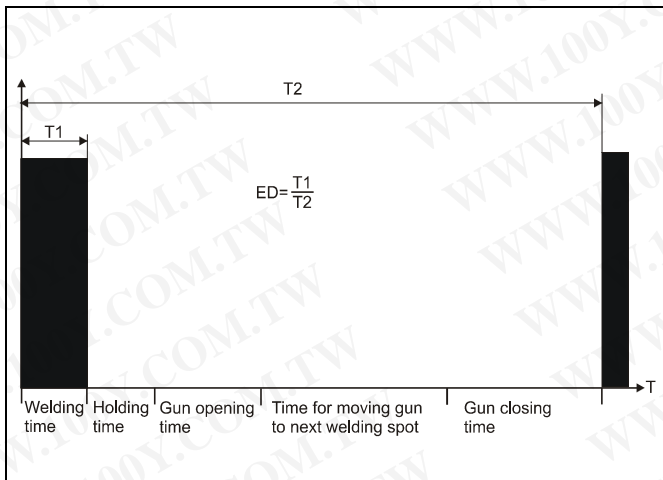

Fig. 7 Definition of ED for typical welding sequence

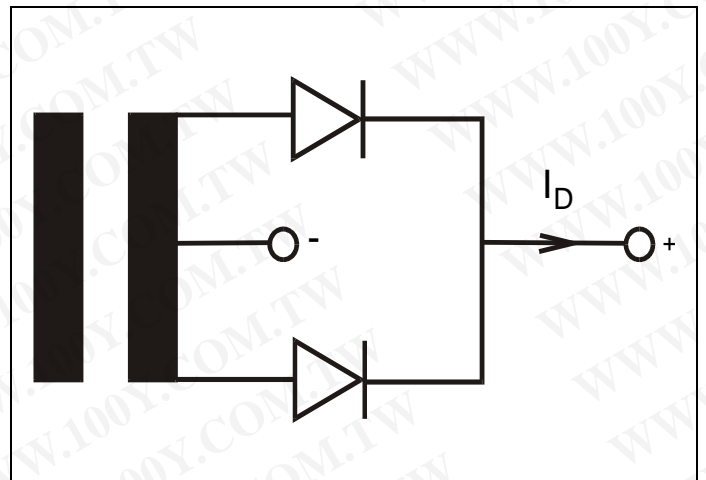

Fig. 8 Definition of ID for single-phase centre tap

ABB Switzerland Ltd, Semiconductors reserves the right to change specifications without notice.



勝特力材料 886-3-5753170
 勝特力电子(上海) 86-21-34970699
 勝特力电子(深圳) 86-755-83298787
[Http://www.100y.com.tw](http://www.100y.com.tw)