

# Surface Mount Microwave Schottky Mixer Diodes

勝特力材料 886-3-5753170  
 勝特力电子(上海) 86-21-54151736  
 勝特力电子(深圳) 86-755-83298787  
 Http://www.100y.com.tw

## Technical Data

**HSMS-8101 Single**  
**HSMS-8202 Series Pair**  
**HSMS-8207 Ring Quad**  
**HSMS-8209 Crossover Quad**

### Features

- Optimized for use at 10-14 GHz
- Low Capacitance
- Low Conversion Loss
- Low RD
- Low Cost Surface Mount Plastic Package
- Lead-free Option Available

### Plastic SOT-23 Package

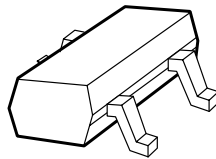

### Plastic SOT-143 Package

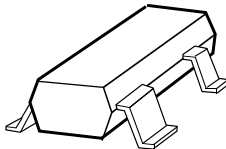

### Description/Applications

These low cost microwave Schottky diodes are specifically designed for use at X/Ku-bands and are ideal for DBS and VSAT downconverter applications. They are available in SOT-23 and SOT-143 standard package configurations.

Note that Agilent's manufacturing techniques assure that dice found in pairs and quads are taken from adjacent sites on the wafer, assuring the highest degree of match.

### Package Lead Code Identification (Top View)

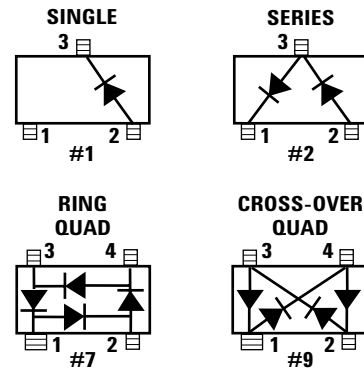

### Absolute Maximum Ratings<sup>[1]</sup>, T<sub>A</sub> = +25°C

Symbol	Parameter	Unit	Min.	Max.
P <sub>T</sub>	Total Device Dissipation <sup>[2]</sup>	mW	—	75
P <sub>IV</sub>	Peak Inverse Voltage	V	—	4
T <sub>J</sub>	Junction Temperature	°C	—	+150
T <sub>STG</sub> , T <sub>op</sub>	Storage and Operating Temperature	°C	-65	+150

### Notes:

1. Operation in excess of any one of these conditions may result in permanent damage to the device.
2. Measured in an infinite heat sink at T<sub>CASE</sub> = 25°C. Derate linearly to zero at 150°C per diode.

### ESD WARNING:

Handling Precautions Should Be Taken To Avoid Static Discharge.

**DC Electrical Specifications,  $T_A = 25^\circ\text{C}$** 

Symbol	Parameters and Test Conditions	Units	HSMS-8101		HSMS-8202		HSMS-8207		HSMS-8209	
			Min.	Max.	Min.	Max.	Min.	Max.	Min.	Max.
$V_{BR}$	Breakdown Voltage $I_R = 10 \mu\text{A}$	V	4		4		4		4	
$C_T$	Total Capacitance $V_R = 0 \text{ V}, f = 1 \text{ MHz}$	pF		0.26		0.26		0.26		0.26
$\Delta C_T$	Capacitance Difference $V_R = 0 \text{ V}, f = 1 \text{ MHz}$	pF		—		0.04		0.04		0.04
$R_D$	Dynamic Resistance $I_F = 5 \text{ mA}$	$\Omega$		14		14		14		14
$\Delta R_D$	Dynamic Resistance Difference $I_F = 5 \text{ mA}$	$\Omega$		—		2		2		2
$V_F$	Forward Voltage $I_F = 1 \text{ mA}$	mV	250	350	250	350	250	350	250	350
$\Delta V_F$	Forward Voltage Difference $I_F = 1 \text{ mA}$	mV		—		20		20		20
Lead Code			1		2		7		9	
Package Marking Code in White where x is date code			R1x		2Rx		R7x		R9x	

**RF Electrical Parameters,  $T_A = 25^\circ\text{C}$** 

Symbol	Parameter	Units	Typical
$L_c$	Conversion Loss at 12 GHz	dB	6.3
$Z_{IF}$	IF Impedance	$\Omega$	150
SWR	SWR at 12 GHz		1.2

**Note:**DC Load Resistance = 0  $\Omega$ ; LO Power = 1 mW.**SPICE Parameters**

$I_S = 4.6 \text{ E-}8$	$E_G = 0.69$	TT = 0
$R_S = 6$	$C_{JO} = 0.18 \text{ E-}12$	
$N = 1.09$	$P_B (V_J) = 0.5$	
$B_V = 7.3$	$M = 0.5$	
$I_{BV} = 10\text{E-}5$	$FC = 0.5$	

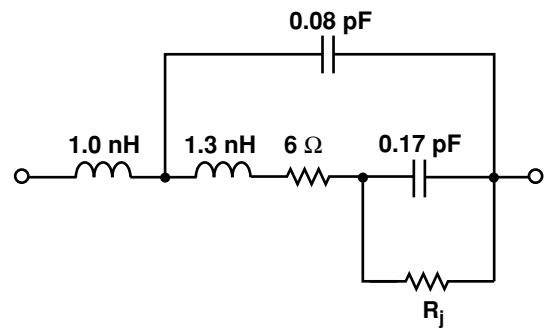
**Linear Equivalent Circuit****Self Bias**

	1 mA	2.5 mA
$R_j$	263	142

### Typical Performance, $T_C = 25^\circ\text{C}$

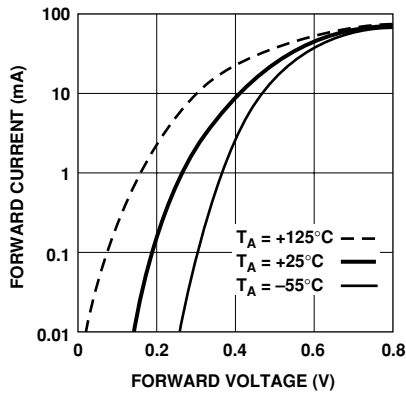

Figure 1. Typical Forward Current vs. Forward Voltage at Three Temperatures.

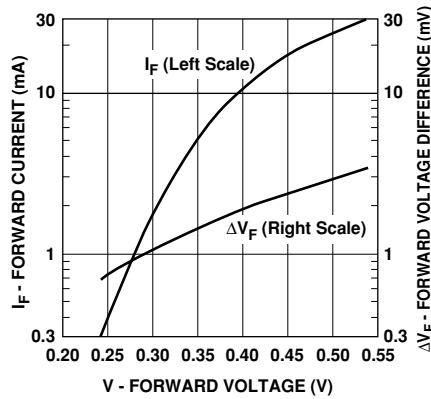

Figure 2. Typical VF Match, HSMS-820X Pairs and Quads.

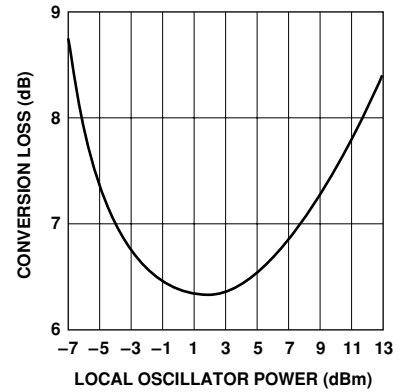
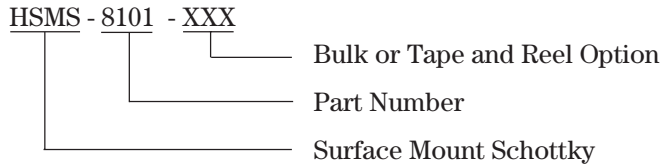

Figure 3. Typical Conversion Loss vs. Local Oscillator Power.

### Ordering Information

Specify part number followed by option. For example:



### Profile Option Descriptions

- BLK = Bulk
- TR1 = 3K pc. Tape and Reel, Device Orientation Figures 4, 5
- TR2 = 10K pc. Tape and Reel, Device Orientation Figures 4, 5

Tape and Reeling conforms to Electronic Industries RS-481, "Taping of Surface Mounted Components for Automated Placement."

For lead-free option, the part number will have the character "G" at the end, eg. -TR2G for a 10K pc lead-free reel.

### Device Orientation

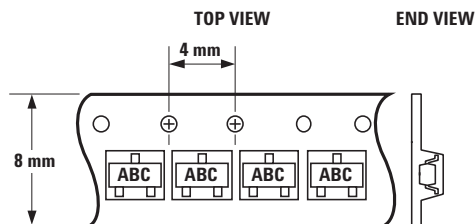
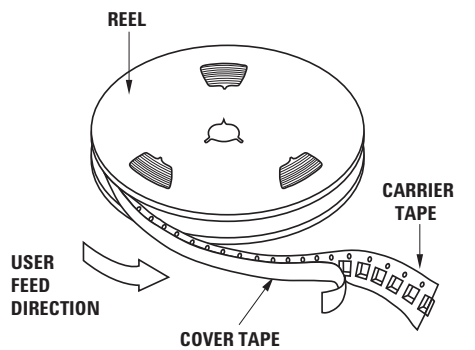

Note: "AB" represents package marking code.  
"C" represents date code.

Figure 4. Option -TR1/-TR2 for SOT-23 Packages.

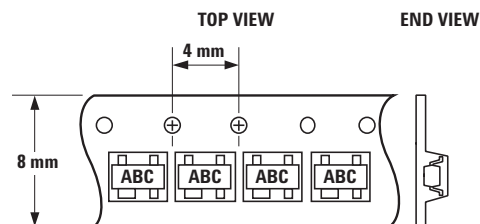

Note: "AB" represents package marking code.  
"C" represents date code.

Figure 5. Option -TR1/-TR2 for SOT-143 Packages.

## Package Characteristics

Lead Material ..... Alloy 42  
 Lead Finish ..... Tin-Lead 85-15%  
 Maximum Soldering Temperature ..... 260°C for 5 seconds  
 Minimum Lead Strength ..... 2 pounds pull  
 Typical Package Inductance ..... 2 nH  
 Typical Package Capacitance ..... 0.08 pF (opposite leads)

## Package Dimensions Outline 23 (SOT-23)

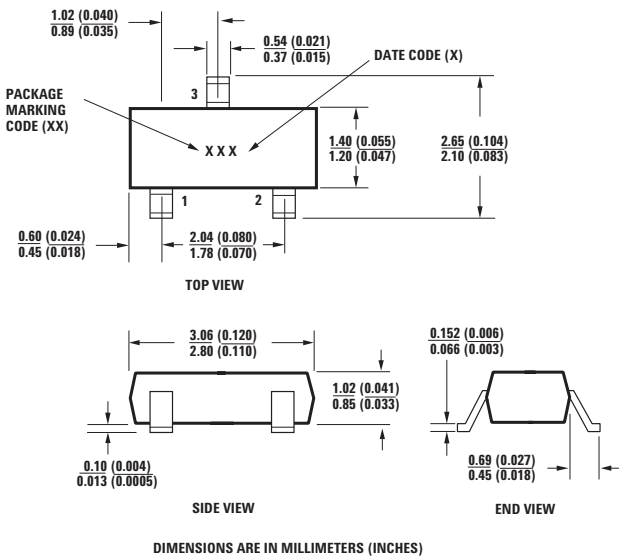

## Outline 143 (SOT-143)

