

Features

- Glass Passivated Die Construction
- Ultra-Fast Recovery Time for High Efficiency
- High Maximum Junction Temperature
- For Use in High Frequency Inverters, Free Wheeling, and Polarity Protection Applications
- High Forward Surge Current Capability
- **Lead Free Finish, RoHS Compliant (Note 1)**
- **"Green" Molding Compound (No Br, Sb)**
- **Qualified to AEC-Q101 Standards for High Reliability**

Mechanical Data

- Case: PowerDI™ 5
- Case Material: Molded Plastic, "Green" Molding Compound. UL Flammability Classification Rating 94V-0
- Moisture sensitivity: Level 1 per J-STD-020C
- Terminals: Finish – Matte Tin annealed over Copper leadframe. Solderable per MIL-STD-202, Method 208 (e3)
- Polarity: See Diagram on Page 4
- Marking: See Page 3
- Weight: 0.096 grams (approx.)



TOP VIEW



BOTTOM VIEW

Maximum Ratings @ T_A = 25°C unless otherwise specified

Single phase, half wave, 60Hz, resistive or inductive load.
For capacitive load, derate current by 20%.

Characteristic	Symbol	Value	Unit
Peak Repetitive Reverse Voltage Working Peak Reverse Voltage DC Blocking Voltage	V _{RRM} V _{RWM} V _R	400	V
RMS Reverse Voltage	V _{R(RMS)}	283	V
Average Rectified Output Current (See also figure 4)	I _O	5	A
Non-Repetitive Peak Forward Surge Current 8.3ms Single half sine-wave Superimposed on Rated Load	I _{FSM}	125	A

Thermal Characteristics

Characteristic	Symbol	Typ	Max	Unit
Thermal Resistance Junction to Soldering Point	R _{θJS}	—	3.0	°C/W
Thermal Resistance Junction to Ambient Air (Note 2)	R _{θJA}	95	—	°C/W
Thermal Resistance Junction to Ambient Air (Note 3)	R _{θJA}	55	—	°C/W
Thermal Resistance Junction to Ambient Air (Note 4)	R _{θJA}	40	—	°C/W
Operating Temperature Range	T _J	-65 to +175		°C
Storage Temperature Range	T _{STG}	-65 to +175		°C

- Notes:
1. RoHS revision 13.2.2003. Glass and High Temperature Solder Exemptions Applied, see *EU Directive Annex Notes 5 and 7*.
 2. FR-4 PCB, 2 oz. Copper, minimum recommended pad layout per <http://www.diodes.com/datasheets/ap02001.pdf>.
 3. Polyimide PCB, 2 oz. Copper, minimum recommended pad layout per <http://www.diodes.com/datasheets/ap02001.pdf>.
 4. Polyimide PCB, 2 oz. Copper. Cathode pad dimensions 9.4mm x 7.2mm. Anode pad dimensions 2.7mm x 1.6mm.

勝特力材料 886-3-5753170
 勝特力电子(上海) 86-21-34970699
 勝特力电子(深圳) 86-755-83298787
[Http://www.100y.com.tw](http://www.100y.com.tw)

Electrical Characteristics @ $T_A = 25^\circ\text{C}$ unless otherwise specified

Characteristic	Symbol	Value	Unit	Test Condition
Minimum Reverse Breakdown Voltage (Note 5)	$V_{(BR)R}$	400	V	$I_R = 10\mu\text{A}$
Maximum Forward Voltage	V_{FM}	1.185 0.935 1.25 1.00	V	$I_F = 5\text{A}, T_S = 25^\circ\text{C}$ $I_F = 5\text{A}, T_S = 150^\circ\text{C}$ $I_F = 8\text{A}, T_S = 25^\circ\text{C}$ $I_F = 8\text{A}, T_S = 150^\circ\text{C}$
Maximum Reverse Leakage Current (Note 5)	I_{RM}	10 500	μA	$T_S = 25^\circ\text{C}, V_R = 400\text{V}$ $T_S = 100^\circ\text{C}, V_R = 400\text{V}$
Maximum Reverse Recovery Time	t_{rr}	35	ns	$I_F = 0.5\text{A}, I_R = 1.0\text{A}$ $I_{RR} = 0.25\text{A}$ (See figure 7)

Notes: 5. Short duration test pulse used to minimize self-heating effect.

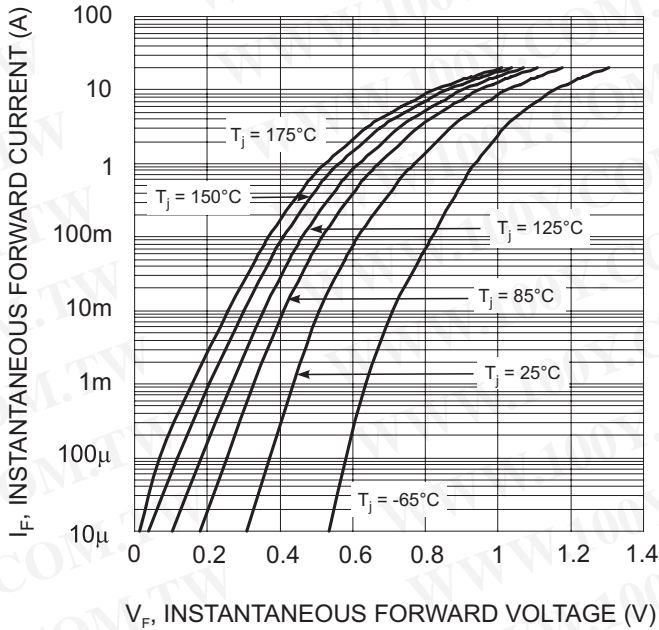

Fig. 1 Typical Forward Characteristics

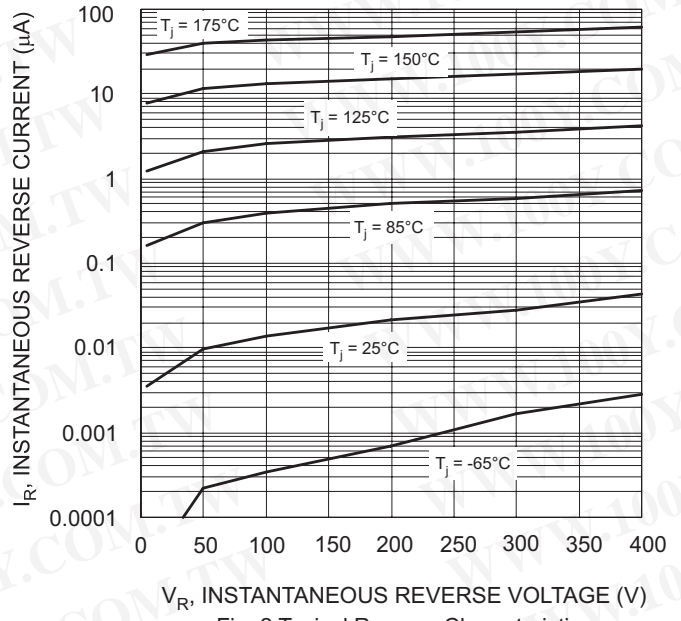

Fig. 2 Typical Reverse Characteristics

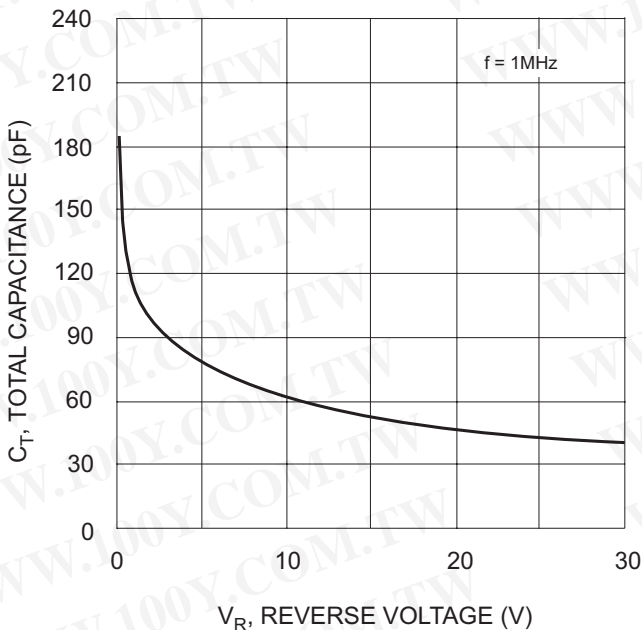

Fig. 3 Typical Total Capacitance vs. Reverse Voltage

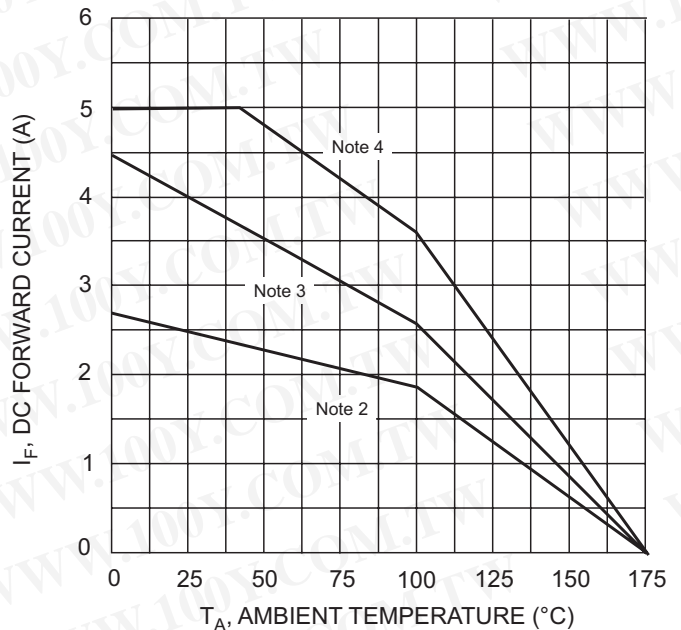

Fig. 4 DC Forward Current Derating

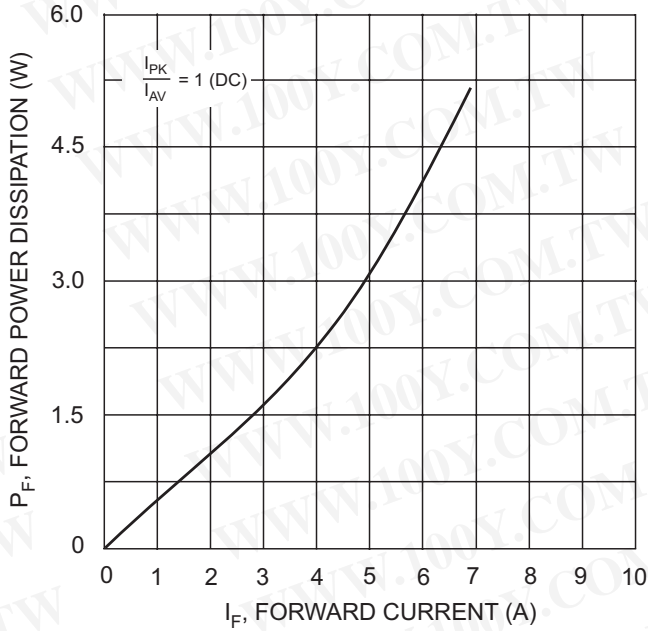

Fig. 5 Forward Power Dissipation

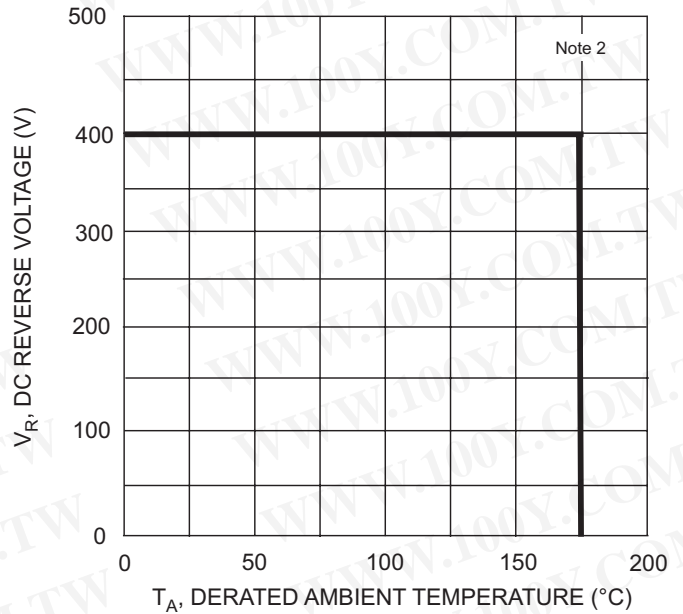
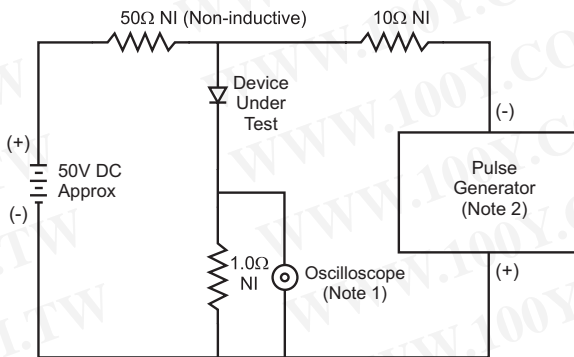
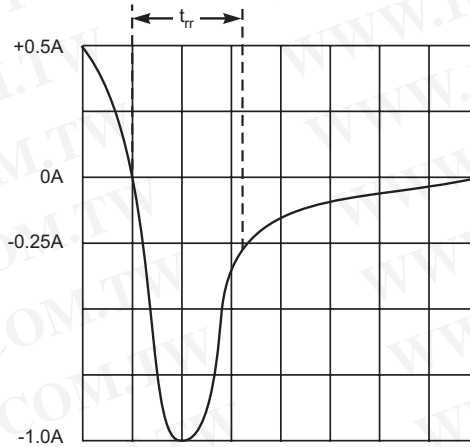

Fig. 6 Operating Temperature Derating



- Notes:
1. Rise Time = 7.0ns max. Input Impedance = 1.0MΩ, 22pF.
 2. Rise Time = 10ns max. Input Impedance = 50Ω.



Set time base for 50/100 ns/cm

Fig. 7 Reverse Recovery Time Characteristic and Test Circuit

Ordering Information (Note 6)

Device	Packaging	Shipping
PDU540-13	PowerDI™5	5000/Tape & Reel

Notes: 6. For Packaging Details, go to our website at <http://www.diodes.com/datasheets/ap02007.pdf>.

Marking Information



U540 = Product type marking code
 ☺; = Manufacturers' code marking
 YYWW = Date code marking
 YY = Last digit of year ex: 06 for 2006
 WW = Week code 01 to 52
 K = Factory Designator

勝特力材料 886-3-5753170
 勝特力电子(上海) 86-21-34970699
 勝特力电子(深圳) 86-755-83298787
[Http://www.100y.com.tw](http://www.100y.com.tw)

Package Outline Dimensions

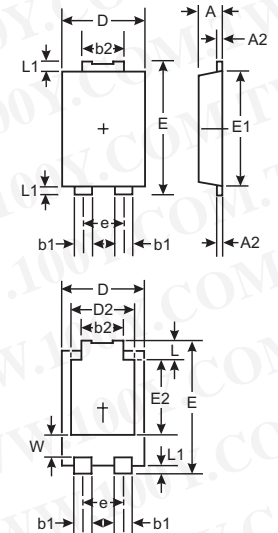

Note: Pins Left & Right must be electrically connected at the printed circuit board.

PowerDI™5		
Dim	Min	Max
A	1.05	1.15
A2	0.33	0.43
b1	0.80	0.99
b2	1.70	1.88
D	3.90	4.05
D2	3.05 NOM	
E	6.40	6.60
e	1.84 NOM	
E1	5.30	5.45
E2	3.55 NOM	
L	0.75	0.95
L1	0.50	0.65
W	1.20	1.50
All Dimensions in mm		

IMPORTANT NOTICE

Diodes Incorporated and its subsidiaries reserve the right to make modifications, enhancements, improvements, corrections or other changes without further notice to any product herein. Diodes Incorporated does not assume any liability arising out of the application or use of any product described herein; neither does it convey any license under its patent rights, nor the rights of others. The user of products in such applications shall assume all risks of such use and will agree to hold Diodes Incorporated and all the companies whose products are represented on our website, harmless against all damages.

LIFE SUPPORT

Diodes Incorporated products are not authorized for use as critical components in life support devices or systems without the expressed written approval of the President of Diodes Incorporated.

勝特力材料 886-3-5753170
 勝特力电子(上海) 86-21-34970699
 勝特力电子(深圳) 86-755-83298787
[Http://www.100y.com.tw](http://www.100y.com.tw)