

1.5A SURFACE MOUNT FAST RECOVERY RECTIFIER

Features

- Glass Passivated Die Construction
- Fast Recovery Time For High Efficiency
- Surge Overload Rating to 50A Peak
- Ideally Suited for Automated Assembly
- **Lead Free Finish/RoHS Compliant (Note 1)**
- **Green Molding Compound (No Halogen and Antimony) (Note 2)**

Mechanical Data

- Case: SMA/SMB
- Case Material: Molded Plastic. UL Flammability Classification Rating 94V-0
- Moisture Sensitivity: Level 1 per J-STD-020
- Terminals: Lead Free Plating (Matte Tin Finish). Solderable per MIL-STD-202, Method 208
- Polarity: Cathode Band or Cathode Notch
- SMA Weight: 0.065 grams (approximate)
- SMB Weight: 0.09 grams (approximate)



Top View



Bottom View

勝特力材料 886-3-5753170
 勝特力电子(上海) 86-21-34970699
 勝特力电子(深圳) 86-755-83298787
[Http://www.100y.com.tw](http://www.100y.com.tw)

Ordering Information (Note 3)

Part Number	Case	Packaging
RS2xA-13-F	SMA	5000/Tape & Reel
RS2x-13-F	SMB	3000/Tape & Reel

*x = Device type, e.g. RS2DA-13-F (SMA package); RS2J-13-F (SMB package).

- Notes:
1. EU Directive 2002/95/EC (RoHS). All applicable RoHS exemptions applied, see EU Directive 2002/95/EC Annex Notes.
 2. Product manufactured with Data Code 0924 (week 24, 2009) and newer are built with Green Molding Compound.
 3. For packaging details, go to our website at <http://www.diodes.com>.

Marking Information

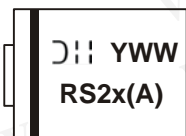

RS2x = Product type marking code, ex: RS2G (SMB package)
 RS2xA = Product type marking code, ex: RS2GA (SMA package)
 D: = Manufacturers' code marking
 YWW = Date code marking
 Y = Last digit of year (ex: 2 for 2002)
 WW = Week code (01 to 53)

Maximum Ratings @ $T_A = 25^\circ\text{C}$ unless otherwise specified

Single phase, half wave, 60Hz, resistive or inductive load.
 For capacitance load, derate current by 20%.

Characteristic	Symbol	RS2 A/AA	RS2 B/BA	RS2 D/DA	RS2 G/GA	RS2 J/JA	RS2 K/KA	RS2 M/MA	Unit
Peak Repetitive Reverse Voltage	V_{RRM}	50	100	200	400	600	800	1000	V
Working Peak Reverse Voltage	V_{RWM}								
DC Blocking Voltage (Note 4)	V_R								
RMS Reverse Voltage	$V_{R(RMS)}$	35	70	140	280	420	560	700	V
Average Rectified Output Current @ $T_T = 120^\circ\text{C}$	I_O	1.5							A
Non-Repetitive Peak Forward Surge Current 8.3ms Single Half Sine-Wave Superimposed on Rated Load	I_{FSM}	50							A

Thermal Characteristics

Characteristic	Symbol	Value	Unit
Typical Thermal Resistance, Junction to Terminal (Note 5)	$R_{\theta JT}$	20	$^\circ\text{C/W}$
Operating and Storage Temperature Range	T_J, T_{STG}	-65 to +150	$^\circ\text{C}$

Electrical Characteristics @ $T_A = 25^\circ\text{C}$ unless otherwise specified

Characteristic	Symbol	RS2 A/AA	RS2 B/BA	RS2 D/DA	RS2 G/GA	RS2 J/JA	RS2 K/KA	RS2 M/MA	Unit
Forward Voltage @ $I_F = 1.5\text{A}$	V_{FM}	1.3							V
Peak Reverse Current @ $T_A = 25^\circ\text{C}$ at Rated DC Blocking Voltage (Note 4) @ $T_A = 125^\circ\text{C}$	I_{RM}	5.0 200							μA
Reverse Recovery Time (Note 6)	t_{rr}	150			250		500		ns
Typical Total Capacitance (Note 7)	C_T	30							pF

- Notes:
4. Short duration pulse test used to minimize self-heating effect.
 5. Reverse recovery test conditions: $I_F = 0.5\text{A}$, $I_R = 1.0\text{A}$, $I_{rr} = 0.25\text{A}$. See Figure 5.
 6. Thermal Resistance: Junction to terminal, unit mounted on PC board with 5.0 mm^2 (0.013 mm thick) copper pads as heat sink.
 7. Measured at 1.0MHz and applied reverse voltage of 4.0V DC .

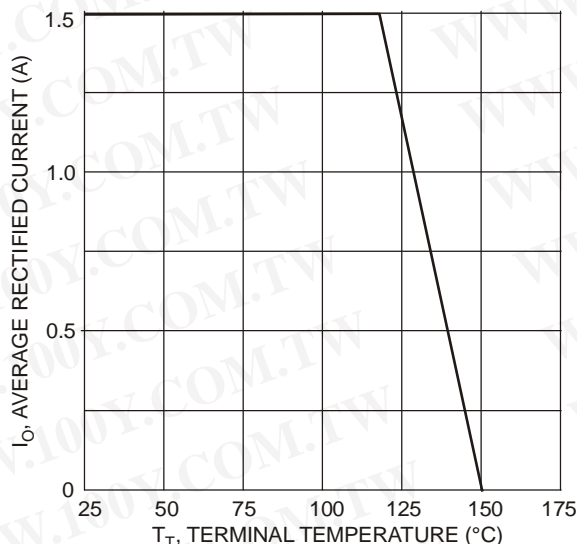

Fig. 1 Forward Current Derating Curve

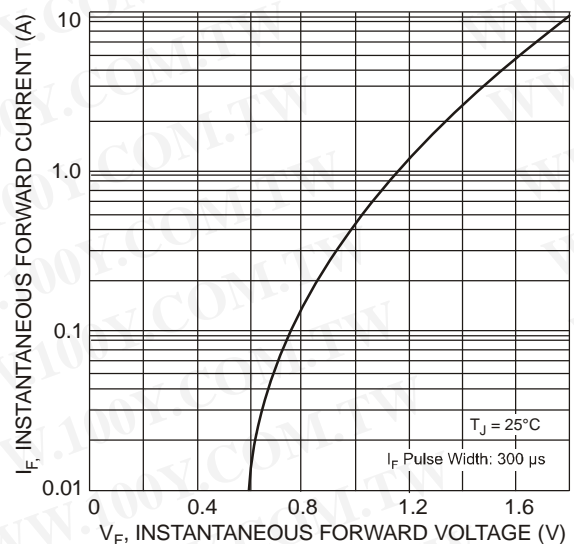

Fig. 2 Typical Forward Characteristics

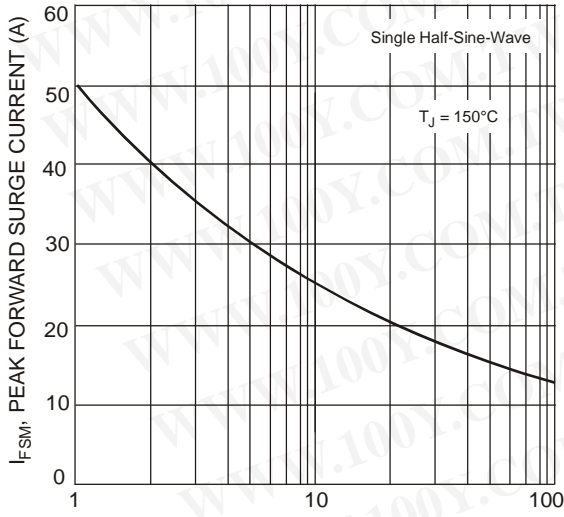

Fig. 3 Forward Surge Current Derating Curve

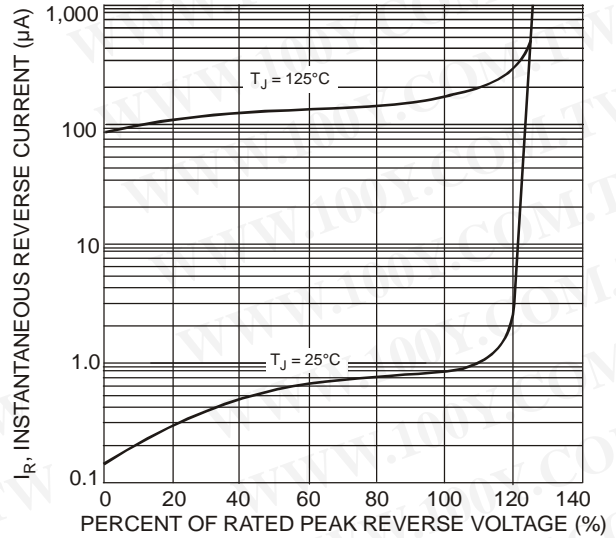
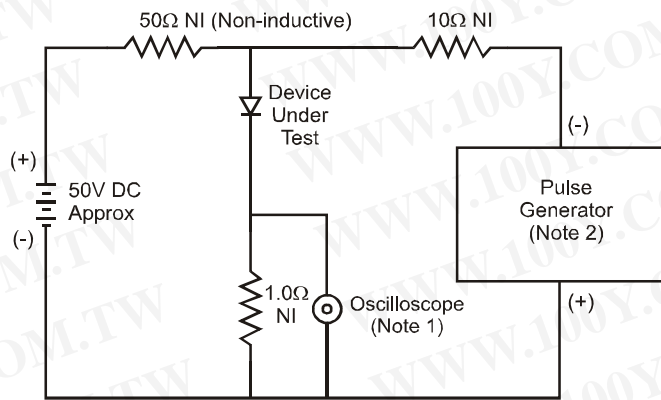
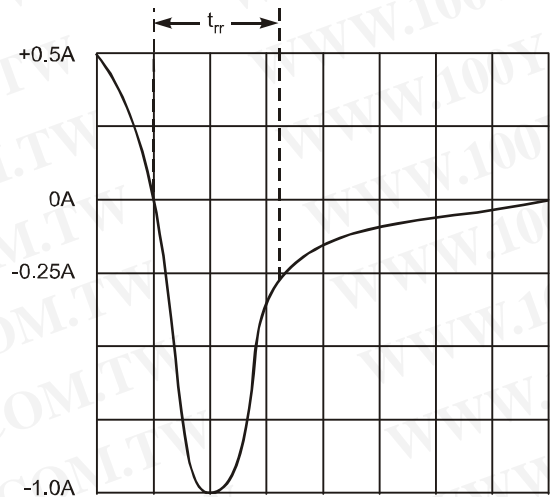

Fig. 4 Typical Reverse Characteristics



- Notes:
1. Rise Time = 7.0ns max. Input Impedance = 1.0MΩ, 22pF.
2. Rise Time = 10ns max. Input Impedance = 50Ω.



Set time base for 50/100 ns/cm

Fig. 5 Reverse Recovery Time Characteristic and Test Circuit

Package Outline Dimensions

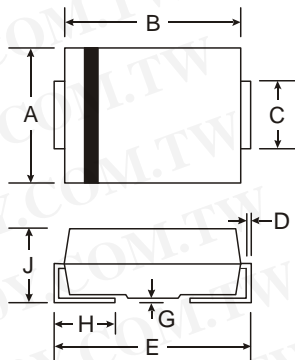

SMA		
Dim	Min	Max
A	2.29	2.92
B	4.00	4.60
C	1.27	1.63
D	0.15	0.31
E	4.80	5.59
G	0.05	0.20
H	0.76	1.52
J	2.01	2.30
All Dimensions in mm		

SMB		
Dim	Min	Max
A	3.30	3.94
B	4.06	4.57
C	1.96	2.21
D	0.15	0.31
E	5.00	5.59
G	0.05	0.20
H	0.76	1.52
J	2.00	2.50
All Dimensions in mm		

Suggested Pad Layout

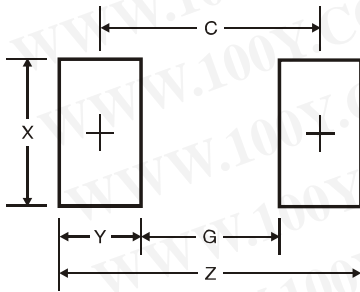

SMA Dimensions	Value (in mm)
Z	6.5
G	1.5
X	1.7
Y	2.5
C	4.0

SMB Dimensions	Value (in mm)
Z	6.7
G	1.8
X	2.3
Y	2.5
C	4.3

IMPORTANT NOTICE

DIODES INCORPORATED MAKES NO WARRANTY OF ANY KIND, EXPRESS OR IMPLIED, WITH REGARDS TO THIS DOCUMENT, INCLUDING, BUT NOT LIMITED TO, THE IMPLIED WARRANTIES OF MERCHANTABILITY AND FITNESS FOR A PARTICULAR PURPOSE (AND THEIR EQUIVALENTS UNDER THE LAWS OF ANY JURISDICTION).

Diodes Incorporated and its subsidiaries reserve the right to make modifications, enhancements, improvements, corrections or other changes without further notice to this document and any product described herein. Diodes Incorporated does not assume any liability arising out of the application or use of this document or any product described herein; neither does Diodes Incorporated convey any license under its patent or trademark rights, nor the rights of others. Any Customer or user of this document or products described herein in such applications shall assume all risks of such use and will agree to hold Diodes Incorporated and all the companies whose products are represented on Diodes Incorporated website, harmless against all damages.

Diodes Incorporated does not warrant or accept any liability whatsoever in respect of any products purchased through unauthorized sales channel. Should Customers purchase or use Diodes Incorporated products for any unintended or unauthorized application, Customers shall indemnify and hold Diodes Incorporated and its representatives harmless against all claims, damages, expenses, and attorney fees arising out of, directly or indirectly, any claim of personal injury or death associated with such unintended or unauthorized application.

Products described herein may be covered by one or more United States, international or foreign patents pending. Product names and markings noted herein may also be covered by one or more United States, international or foreign trademarks.

LIFE SUPPORT

Diodes Incorporated products are specifically not authorized for use as critical components in life support devices or systems without the express written approval of the Chief Executive Officer of Diodes Incorporated. As used herein:

A. Life support devices or systems are devices or systems which:

1. are intended to implant into the body, or
2. support or sustain life and whose failure to perform when properly used in accordance with instructions for use provided in the labeling can be reasonably expected to result in significant injury to the user.

B. A critical component is any component in a life support device or system whose failure to perform can be reasonably expected to cause the failure of the life support device or to affect its safety or effectiveness.

Customers represent that they have all necessary expertise in the safety and regulatory ramifications of their life support devices or systems, and acknowledge and agree that they are solely responsible for all legal, regulatory and safety-related requirements concerning their products and any use of Diodes Incorporated products in such safety-critical, life support devices or systems, notwithstanding any devices- or systems-related information or support that may be provided by Diodes Incorporated. Further, Customers must fully indemnify Diodes Incorporated and its representatives against any damages arising out of the use of Diodes Incorporated products in such safety-critical, life support devices or systems.

Copyright © 2010, Diodes Incorporated

www.diodes.com