



## ESDA8V2-1J

### EOS and ESD Transil™ protection for charger and battery port

#### Features

- Breakdown voltage  $V_{BR} = 8.2 \text{ V}$
- Unidirectional device
- High peak power dissipation: 500 W (8/20  $\mu\text{s}$  waveform)
- ESD protection level better than IEC 61000-4-2, level 4: 30 kV contact discharge
- Low leakage current ( $< 0.5 \mu\text{A}$  @ 5 V)

#### Benefits

- High EOS and ESD protection level
- High integration
- Suitable for high density boards

#### Complies with the following standards:

- IEC 61000-4-2 level 4
  - $\pm 15 \text{ kV}$  (air discharge)
  - $\pm 8 \text{ kV}$  (contact discharge)
- MIL STD 883G - Method 3015-7: class 3B
  - HBM (human body model):  $\geq 8 \text{ kV}$

#### Applications

This product is particularly recommended for the protection of power supply lines of portable devices, where EOS and ESD transient overvoltage protection in sensitive equipment is required, such as:

- Computers
- Printers
- Communication systems
- Cellular phone handsets and accessories
- Video equipment

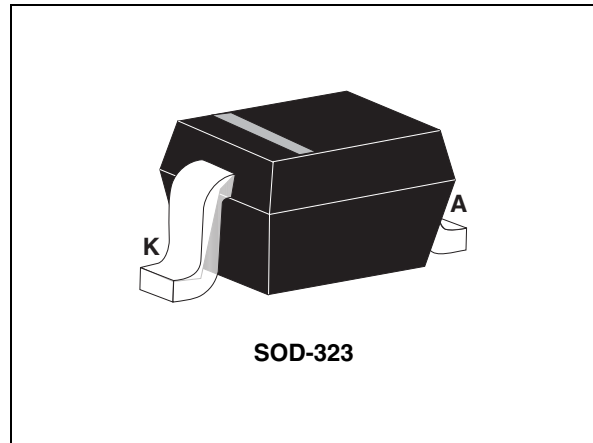
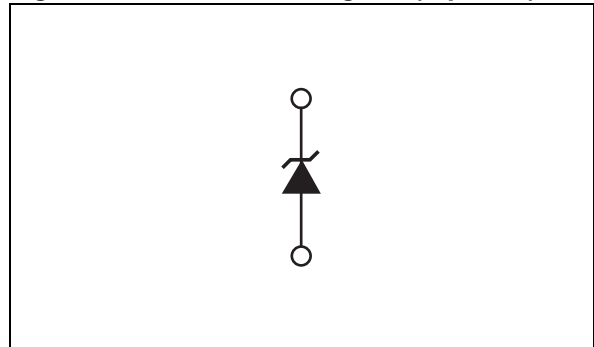


Figure 1. Functional diagram (top view)



#### Description

The ESDA8V2-1J is a unidirectional single line Transil diode designed specifically for the protection of integrated circuits in portable equipment and miniaturized electronic devices subject to EOS and ESD transient overvoltages.

TM: Transil is a trademark of STMicroelectronics

# 1 Characteristics

**Table 1. Absolute maximum ratings ( $T_{amb} = 25\text{ }^{\circ}\text{C}$ )**

Symbol	Parameter	Value	Unit
$V_{PP}$	ESD discharge:		
	IEC 61000-4-2 air discharge on input pin	$\pm 30$	kV
	IEC 61000-4-2 contact discharge on input pin	$\pm 30$	
MIL STD 883G - Method 3015-7: class 3B	$\pm 30$		
$P_{PP}$	Peak pulse power dissipation (8/20 $\mu\text{s}$ ) <sup>(1)</sup>	500	W
	$T_j$ initial = $T_{amb}$		
$I_{PP}$	Peak pulse current (8/20 $\mu\text{s}$ )	25	A
$T_j$	Junction temperature range	-40 to +125	$^{\circ}\text{C}$
$T_{stg}$	Storage temperature range	- 55 to +150	$^{\circ}\text{C}$
$T_L$	Maximum lead temperature for soldering during 10 s	260	$^{\circ}\text{C}$

1. For a surge greater than the maximum values, the diode will fail in short-circuit

**Table 2. Electrical characteristics (definitions)**

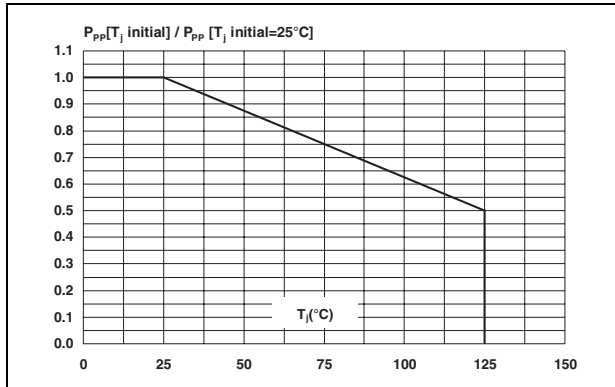
Symbol	Parameter
$V_{BR}$	Breakdown voltage
$I_{RM}$	Leakage current @ $V_{RM}$
$V_{RM}$	Stand-of voltage
$V_{CL}$	Clamping voltage
$I_{PP}$	Peak pulse current
C	Input capacitance

**Table 3. Electrical characteristics (values,  $T_{amb} = 25\text{ }^{\circ}\text{C}$ )**

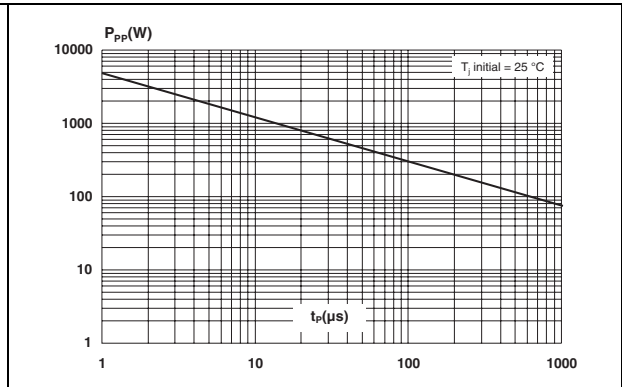
Symbol	Parameter	Test condition	Min.	Typ.	Max.	Unit
$V_{BR}$	Breakdown voltage	$I_R = 1\text{ mA}$	8.2	-	-	V
$I_{RM}$	Leakage current @ $V_{RM}$	$V_{RM} = 5\text{ V}$	-	0.1	0.5	$\mu\text{A}$
$V_{CL}$	Clamping voltage (8/20 $\mu\text{s}$ waveform)	$I_{PP} = 1\text{ A}$	-	-	11	V
		$I_{PP} = 5\text{ A}$	-	-	13	V
		$I_{PP} = 25\text{ A}$	-	-	20	V
C	Input capacitance	$V_R = 0\text{ V}$ , $F_{osc} = 1\text{ MHz}$ , $V_{osc} = 30\text{ mV}$	-	210	250	pF

勝特力材料 886-3-5753170  
 勝特力电子(上海) 86-21-34970699  
 勝特力电子(深圳) 86-755-83298787  
[Http://www.100y.com.tw](http://www.100y.com.tw)

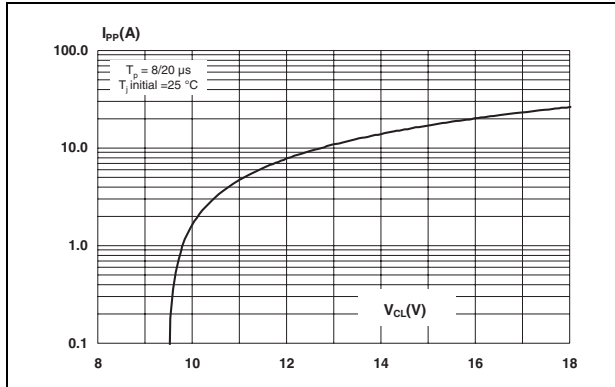
**Figure 2. Relative variation of peak pulse power versus initial junction temperature**



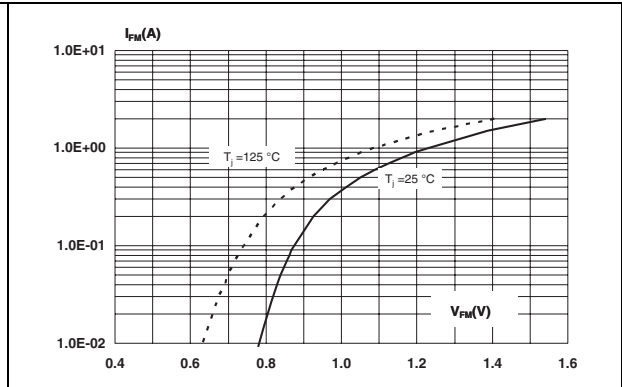
**Figure 3. Peak pulse power versus exponential pulse duration**



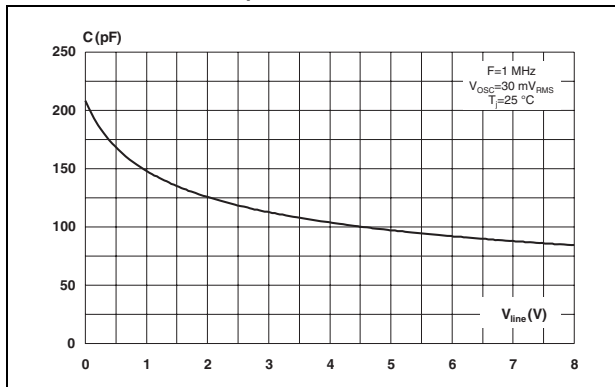
**Figure 4. Clamping voltage versus peak pulse current (typical values, exponential waveform)**



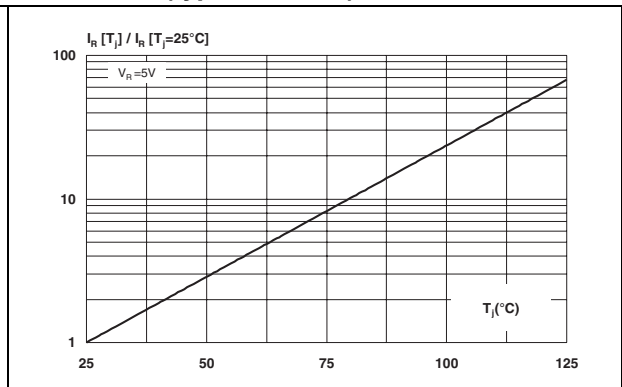
**Figure 5. Forward voltage drop versus peak forward current (typical values)**



**Figure 6. Junction capacitance versus reverse voltage applied (typical values)**



**Figure 7. Relative variation of leakage current versus junction temperature (typical values)**



勝特力材料 886-3-5753170  
 勝特力电子(上海) 86-21-34970699  
 勝特力电子(深圳) 86-755-83298787  
[Http://www.100y.com.tw](http://www.100y.com.tw)

Figure 8. ESD response to IEC 61000-4-2 (+15 kV air discharge)

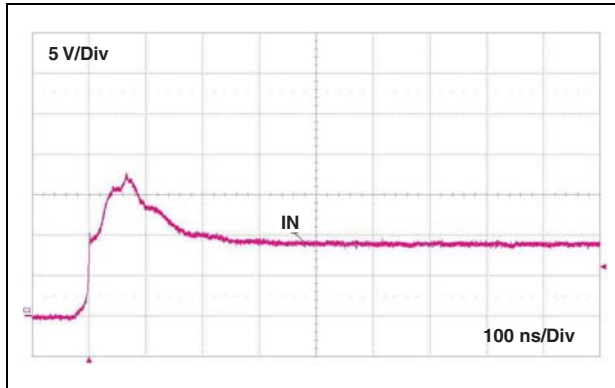
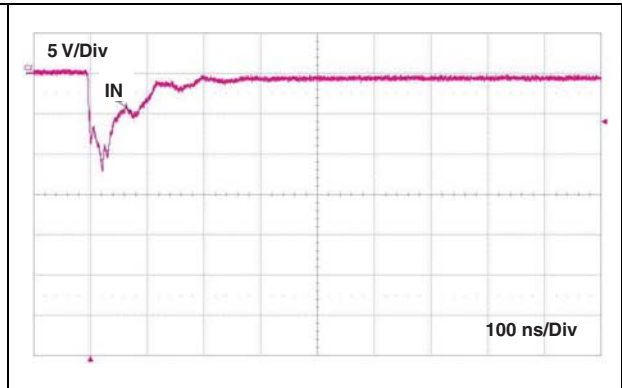
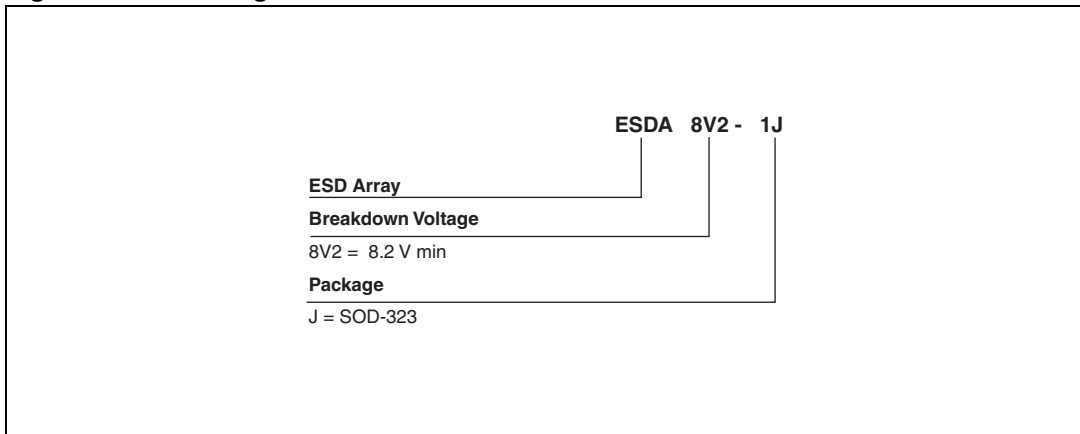


Figure 9. ESD response to IEC 61000-4-2 (-15 kV air discharge)



## 2 Ordering information scheme

Figure 10. Ordering information scheme



勝特力材料 886-3-5753170  
勝特力电子(上海) 86-21-34970699  
勝特力电子(深圳) 86-755-83298787  
[Http://www.100y.com.tw](http://www.100y.com.tw)

### 3 Package information

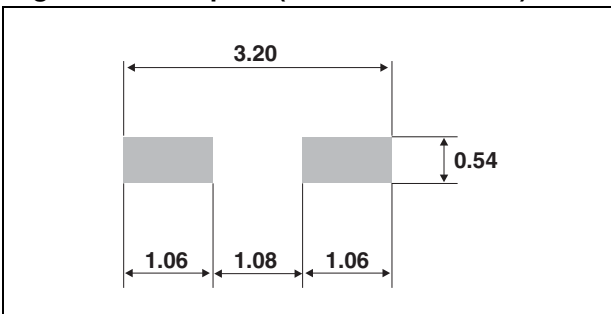
- Epoxy meets UL94, V0
- Bar indicates cathode

In order to meet environmental requirements, ST offers these devices in different grades of ECOPACK® packages, depending on their level of environmental compliance. ECOPACK® specifications, grade definitions and product status are available at: [www.st.com](http://www.st.com). ECOPACK® is an ST trademark.

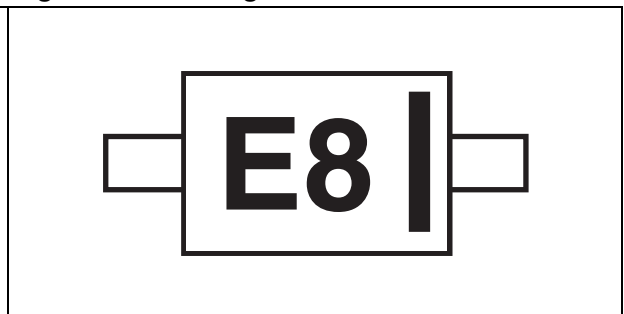
**Table 4. SOD-323 dimensions**

Ref.	Dimensions			
	Millimeters		Inches	
	Min.	Max.	Min.	Max.
A		1.17		0.046
A1	0	0.1	0	0.004
b	0.25	0.44	0.01	0.017
c	0.1	0.25	0.004	0.01
D	1.52	1.8	0.06	0.071
E	1.11	1.45	0.044	0.057
H	2.3	2.7	0.09	0.106
L	0.1	0.46	0.004	0.02
Q1	0.1	0.41	0.004	0.016

**Figure 11. Footprint (dimensions in mm)**

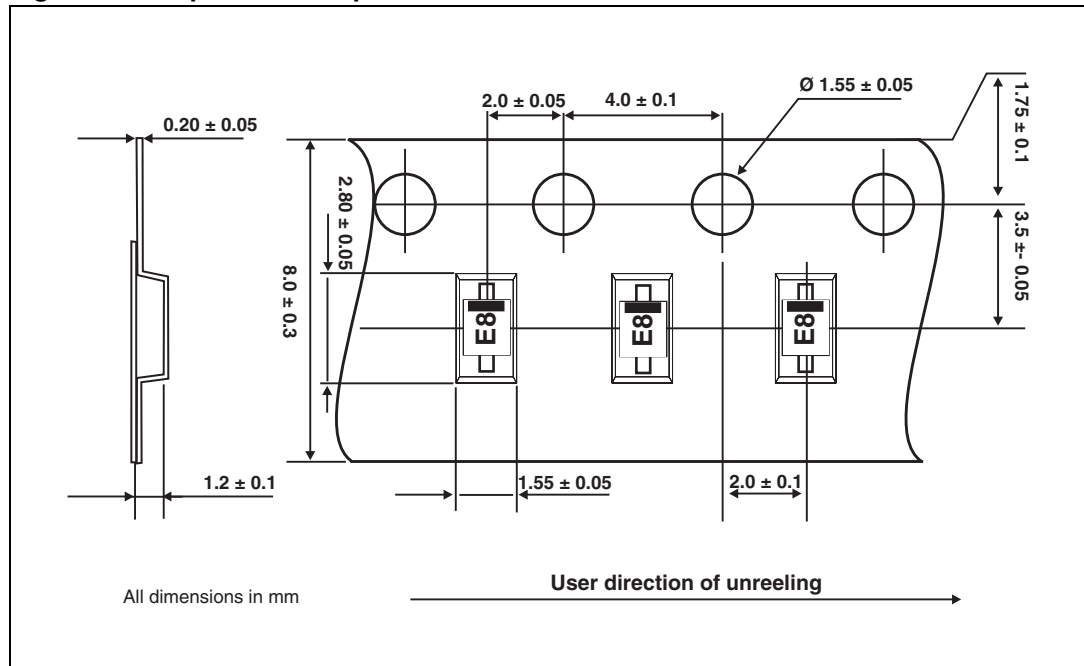


**Figure 12. Marking**



勝特力材料 886-3-5753170  
 勝特力电子(上海) 86-21-34970699  
 勝特力电子(深圳) 86-755-83298787  
[Http://www.100y.com.tw](http://www.100y.com.tw)

Figure 13. Tape and reel specifications



## 4 Ordering information

Table 5. Ordering information

Order code	Marking	Weight	Base qty	Delivery mode
ESDA8V2-1J	E8	5 mg	3000	Tape and reel

## 5 Revision history

Table 6. Document revision history

Date	Revision	Changes
11-Aug-2009	1	Initial release

勝特力材料 886-3-5753170  
 勝特力电子(上海) 86-21-34970699  
 勝特力电子(深圳) 86-755-83298787  
[Http://www.100y.com.tw](http://www.100y.com.tw)



**Please Read Carefully:**

Information in this document is provided solely in connection with ST products. STMicroelectronics NV and its subsidiaries ("ST") reserve the right to make changes, corrections, modifications or improvements, to this document, and the products and services described herein at any time, without notice.

All ST products are sold pursuant to ST's terms and conditions of sale.

Purchasers are solely responsible for the choice, selection and use of the ST products and services described herein, and ST assumes no liability whatsoever relating to the choice, selection or use of the ST products and services described herein.

No license, express or implied, by estoppel or otherwise, to any intellectual property rights is granted under this document. If any part of this document refers to any third party products or services it shall not be deemed a license grant by ST for the use of such third party products or services, or any intellectual property contained therein or considered as a warranty covering the use in any manner whatsoever of such third party products or services or any intellectual property contained therein.

**UNLESS OTHERWISE SET FORTH IN ST'S TERMS AND CONDITIONS OF SALE ST DISCLAIMS ANY EXPRESS OR IMPLIED WARRANTY WITH RESPECT TO THE USE AND/OR SALE OF ST PRODUCTS INCLUDING WITHOUT LIMITATION IMPLIED WARRANTIES OF MERCHANTABILITY, FITNESS FOR A PARTICULAR PURPOSE (AND THEIR EQUIVALENTS UNDER THE LAWS OF ANY JURISDICTION), OR INFRINGEMENT OF ANY PATENT, COPYRIGHT OR OTHER INTELLECTUAL PROPERTY RIGHT.**

**UNLESS EXPRESSLY APPROVED IN WRITING BY AN AUTHORIZED ST REPRESENTATIVE, ST PRODUCTS ARE NOT RECOMMENDED, AUTHORIZED OR WARRANTED FOR USE IN MILITARY, AIR CRAFT, SPACE, LIFE SAVING, OR LIFE SUSTAINING APPLICATIONS, NOR IN PRODUCTS OR SYSTEMS WHERE FAILURE OR MALFUNCTION MAY RESULT IN PERSONAL INJURY, DEATH, OR SEVERE PROPERTY OR ENVIRONMENTAL DAMAGE. ST PRODUCTS WHICH ARE NOT SPECIFIED AS "AUTOMOTIVE GRADE" MAY ONLY BE USED IN AUTOMOTIVE APPLICATIONS AT USER'S OWN RISK.**

Resale of ST products with provisions different from the statements and/or technical features set forth in this document shall immediately void any warranty granted by ST for the ST product or service described herein and shall not create or extend in any manner whatsoever, any liability of ST.

ST and the ST logo are trademarks or registered trademarks of ST in various countries.

Information in this document supersedes and replaces all information previously supplied.

The ST logo is a registered trademark of STMicroelectronics. All other names are the property of their respective owners.

© 2009 STMicroelectronics - All rights reserved

STMicroelectronics group of companies

Australia - Belgium - Brazil - Canada - China - Czech Republic - Finland - France - Germany - Hong Kong - India - Israel - Italy - Japan - Malaysia - Malta - Morocco - Philippines - Singapore - Spain - Sweden - Switzerland - United Kingdom - United States of America

[www.st.com](http://www.st.com)