



FDMA1023PZ Dual P-Channel PowerTrench® MOSFET

-20V, -3.7A, 72mΩ

Features

- Max $r_{DS(on)}$ = 72mΩ at $V_{GS} = -4.5V$, $I_D = -3.7A$
- Max $r_{DS(on)}$ = 95mΩ at $V_{GS} = -2.5V$, $I_D = -3.2A$
- Max $r_{DS(on)}$ = 130mΩ at $V_{GS} = -1.8V$, $I_D = -2.0A$
- Max $r_{DS(on)}$ = 195mΩ at $V_{GS} = -1.5V$, $I_D = -1.0A$
- Low profile - 0.8 mm maximum - in the new package MicroFET 2x2 mm
- HBM ESD protection level > 2kV typical (Note 3)
- RoHS Compliant
- Free from halogenated compounds and antimony oxides



General Description

This device is designed specifically as a single package solution for the battery charge switch in cellular handset and other ultra-portable applications. It features two independent P-Channel MOSFETs with low on-state resistance for minimum conduction losses. When connected in the typical common source configuration, bi-directional current flow is possible.

The MicroFET 2X2 package offers exceptional thermal performance for its physical size and is well suited to linear mode applications.

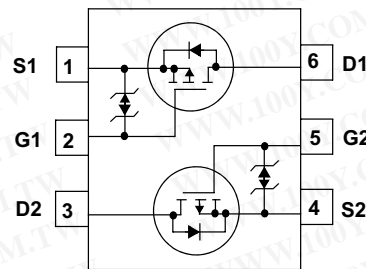
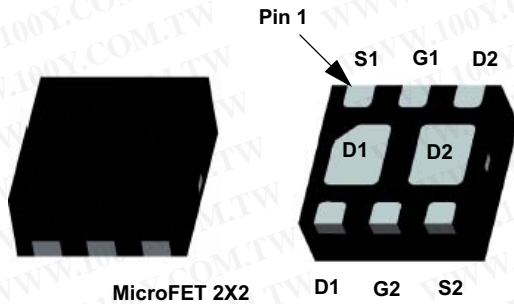

MOSFET Maximum Ratings $T_A = 25^\circ C$ unless otherwise noted

Symbol	Parameter	Rated	Units
V_{DS}	Drain to Source Voltage	-20	V
V_{GS}	Gate to Source Voltage	±8	V
I_D	Drain Current -Continuous	(Note 1a) -3.7	A
	-Pulsed	-6	
P_D	Power Dissipation	(Note 1a) 1.5	W
		(Note 1b) 0.7	
T_J, T_{STG}	Operating and Storage Junction Temperature Range	-55 to +150	°C

Thermal Characteristics

$R_{\theta JA}$	Thermal Resistance for Single Operation, Junction to Ambient	(Note 1a) 86	°C/W
$R_{\theta JA}$	Thermal Resistance for Single Operation, Junction to Ambient	(Note 1b) 173	
$R_{\theta JA}$	Thermal Resistance for Dual Operation, Junction to Ambient	(Note 1c) 69	
$R_{\theta JA}$	Thermal Resistance for Dual Operation, Junction to Ambient	(Note 1d) 151	

Package Marking and Ordering Information

Device Marking	Device	Package	Reel Size	Tape Width	Quantity
023	FDMA1023PZ	MicroFET 2X2	7"	8mm	3000 units

Electrical Characteristics $T_J = 25^\circ\text{C}$ unless otherwise noted

Symbol	Parameter	Test Conditions	Min	Typ	Max	Units
--------	-----------	-----------------	-----	-----	-----	-------

Off Characteristics

BV_{DSS}	Drain to Source Breakdown Voltage	$I_D = -250\mu\text{A}$, $V_{GS} = 0\text{V}$	-20			V
$\frac{\Delta BV_{DSS}}{\Delta T_J}$	Breakdown Voltage Temperature Coefficient	$I_D = -250\mu\text{A}$, referenced to 25°C		-11		mV/ $^\circ\text{C}$
I_{DSS}	Zero Gate Voltage Drain Current	$V_{DS} = -16\text{V}$, $V_{GS} = 0\text{V}$			-1	μA
I_{GSS}	Gate to Source Leakage Current	$V_{GS} = \pm 8\text{V}$, $V_{DS} = 0\text{V}$			± 10	μA

On Characteristics

$V_{GS(th)}$	Gate to Source Threshold Voltage	$V_{GS} = V_{DS}$, $I_D = -250\mu\text{A}$	-0.4	-0.7	-1.0	V
$\frac{\Delta V_{GS(th)}}{\Delta T_J}$	Gate to Source Threshold Voltage Temperature Coefficient	$I_D = -250\mu\text{A}$, referenced to 25°C		2.5		mV/ $^\circ\text{C}$
$r_{DS(on)}$	Static Drain to Source On-Resistance	$V_{GS} = -4.5\text{V}$, $I_D = -3.7\text{A}$		60	72	m Ω
		$V_{GS} = -2.5\text{V}$, $I_D = -3.2\text{A}$		75	95	
		$V_{GS} = -1.8\text{V}$, $I_D = -2.0\text{A}$		100	130	
		$V_{GS} = -1.5\text{V}$, $I_D = -1.0\text{A}$		130	195	
		$V_{GS} = -4.5\text{V}$, $I_D = -3.7\text{A}$, $T_J = 125^\circ\text{C}$		81	91	
g_{FS}	Forward Transconductance	$V_{DS} = -5\text{V}$, $I_D = -3.7\text{A}$		12		S

Dynamic Characteristics

C_{iss}	Input Capacitance	$V_{DS} = -10\text{V}$, $V_{GS} = 0\text{V}$, $f = 1\text{MHz}$		490	655	pF
C_{oss}	Output Capacitance			100	135	pF
C_{rss}	Reverse Transfer Capacitance			90	135	pF

Switching Characteristics

$t_{d(on)}$	Turn-On Delay Time	$V_{DD} = -10\text{V}$, $I_D = -1\text{A}$ $V_{GS} = -4.5\text{V}$, $R_{GEN} = 6\Omega$		9	18	ns
t_r	Rise Time			12	22	ns
$t_{d(off)}$	Turn-Off Delay Time			64	103	ns
t_f	Fall Time			37	60	ns
$Q_{g(TOT)}$	Total Gate Charge		$V_{DD} = -10\text{V}$, $I_D = -3.7\text{A}$		8.6	12
Q_{gs}	Gate to Source Gate Charge	$V_{GS} = -4.5\text{V}$		0.7		nC
Q_{gd}	Gate to Drain "Miller" Charge			2.0		nC

Drain-Source Diode Characteristics

I_S	Maximum Continuous Source-Drain Diode Forward Current			-1.1		A
V_{SD}	Source to Drain Diode Forward Voltage	$V_{GS} = 0\text{V}$, $I_S = -1.1\text{A}$ (Note 2)	-0.8	-1.2		V
t_{rr}	Reverse Recovery Time	$I_F = -3.7\text{A}$, $di/dt = 100\text{A}/\mu\text{s}$		32	48	ns
Q_{rr}	Reverse Recovery Charge			15	23	nC

Notes:

1: $R_{\theta JA}$ is determined with the device mounted on a 1 in² oz. copper pad on a 1.5 x 1.5 in. board of FR-4 material. $R_{\theta JC}$ is guaranteed by design while $R_{\theta JA}$ is determined by the user's board design.

- (a) $R_{\theta JA} = 86^{\circ}\text{C/W}$ when mounted on a 1 in² pad of 2 oz copper, 1.5" x 1.5" x 0.062" thick PCB. For single operation.
- (b) $R_{\theta JA} = 173^{\circ}\text{C/W}$ when mounted on a minimum pad of 2 oz copper. For single operation.
- (c) $R_{\theta JA} = 69^{\circ}\text{C/W}$ when mounted on a 1 in² pad of 2 oz copper, 1.5" x 1.5" x 0.062" thick PCB, For dual operation.
- (d) $R_{\theta JA} = 151^{\circ}\text{C/W}$ when mounted on a minimum pad of 2 oz copper. For dual operation.



a) 86°C/W when mounted on a 1 in² pad of 2 oz copper.

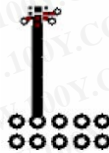

b) 173°C/W when mounted on a minimum pad of 2 oz copper.



c) 69°C/W when mounted on a 1 in² pad of 2 oz copper.



d) 151°C/W when mounted on a minimum pad of 2 oz copper.

2: Pulse Test : Pulse Width < 300us, Duty Cycle < 2.0%

3: The diode connected between the gate and source serves only as protection against ESD. No gate overvoltage rating is implied.

Typical Characteristics $T_J = 25^\circ\text{C}$ unless otherwise noted

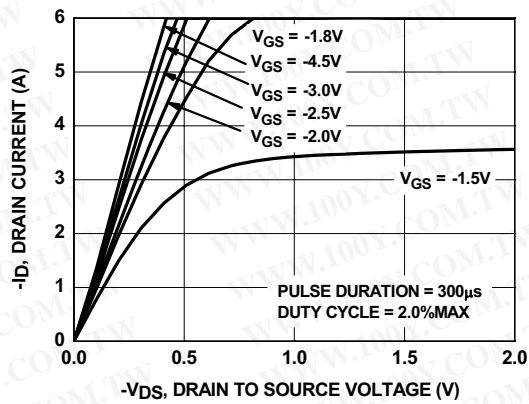

Figure 1. On Region Characteristics

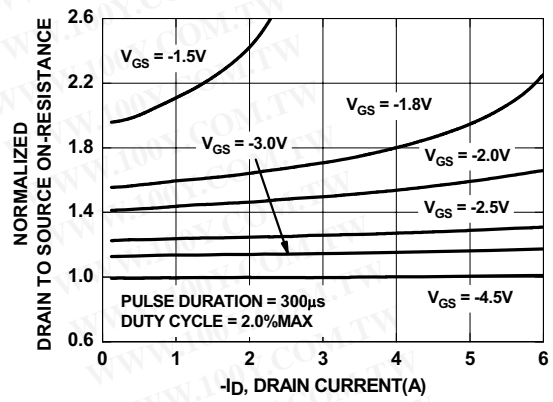

Figure 2. Normalized On-Resistance vs Drain Current and Gate Voltage

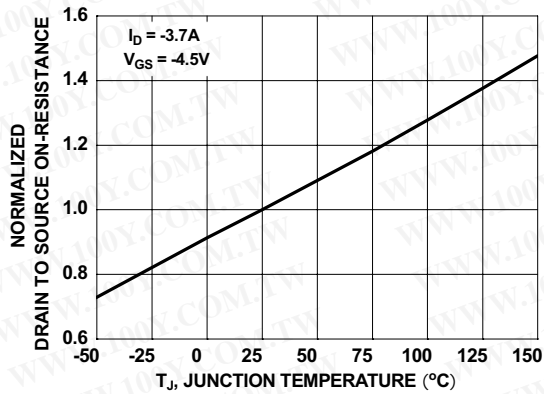

Figure 3. Normalized On-Resistance vs Junction Temperature

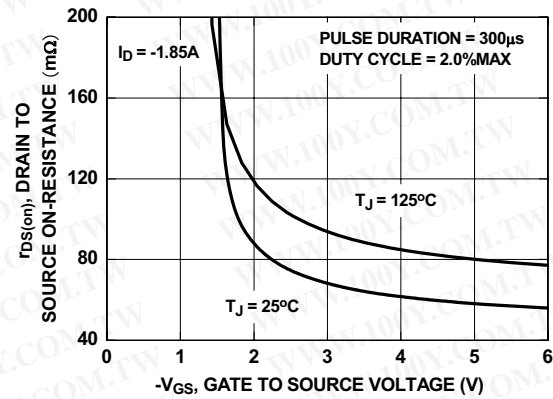

Figure 4. On-Resistance vs Gate to Source Voltage

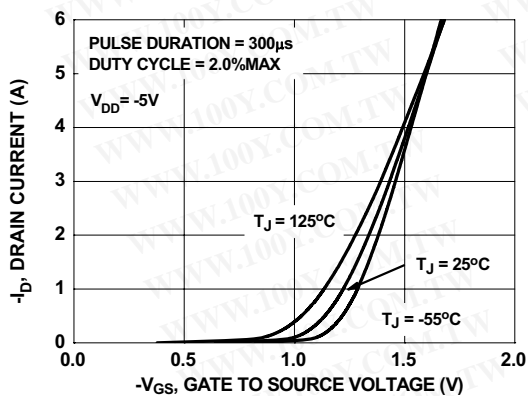

Figure 5. Transfer Characteristics

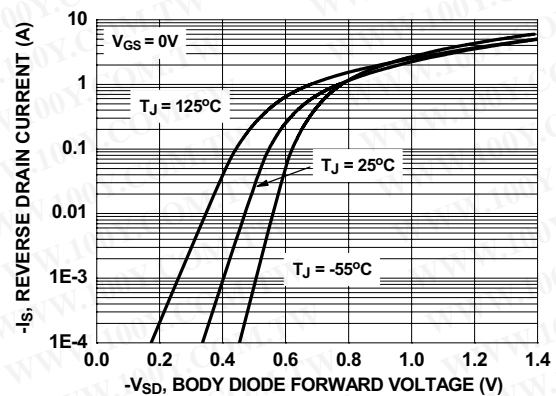

Figure 6. Source to Drain Diode Forward Voltage vs Source Current

Typical Characteristics $T_J = 25^\circ\text{C}$ unless otherwise noted

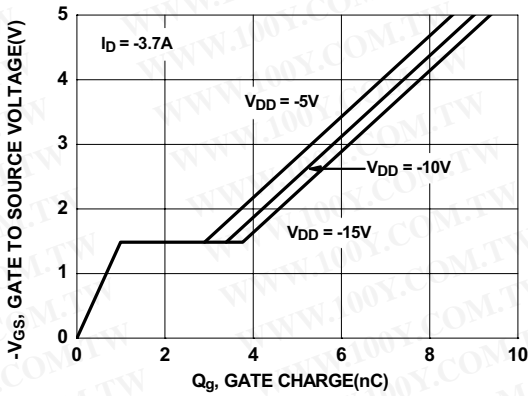

Figure 7. Gate Charge Characteristics

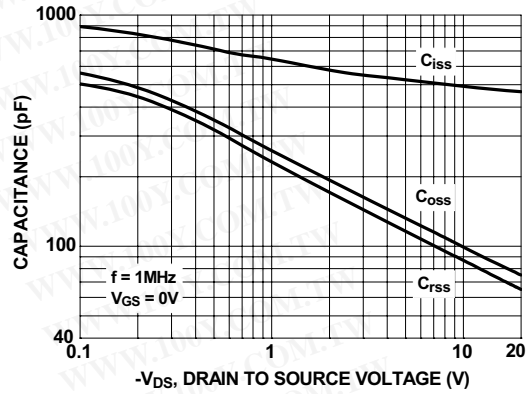

Figure 8. Capacitance Characteristics

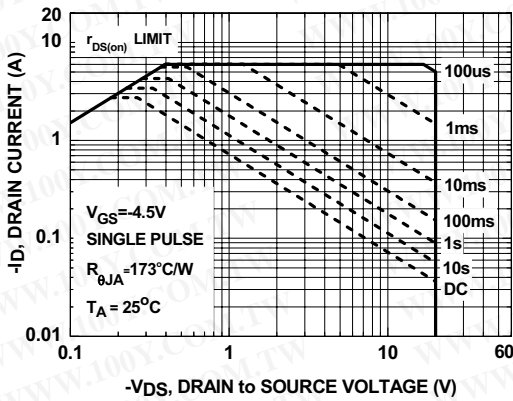

Figure 9. Forward Bias Safe Operating Area

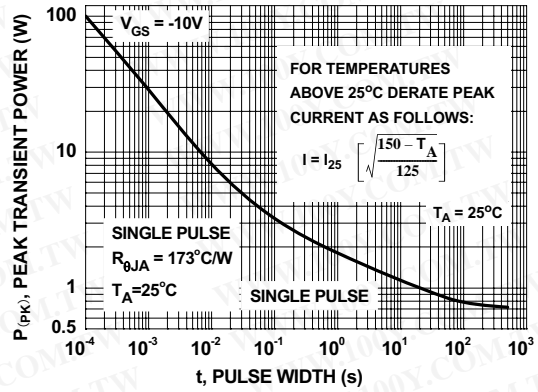

Figure 10. Single Pulse Maximum Power Dissipation

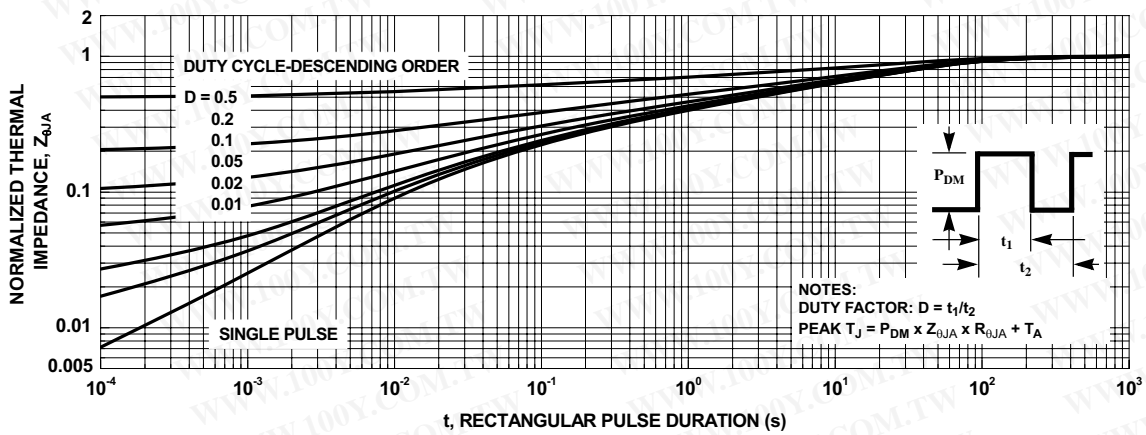
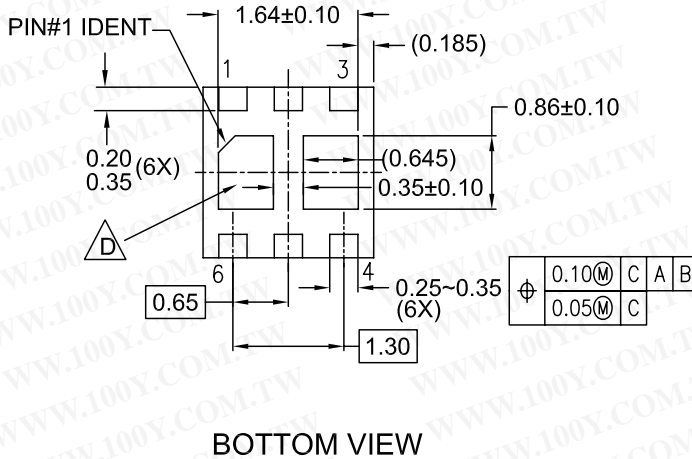
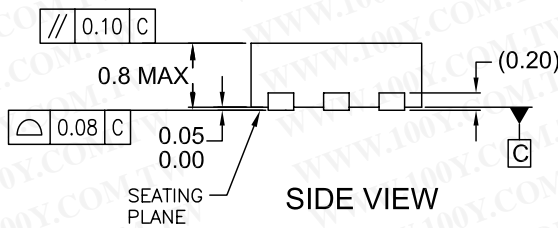
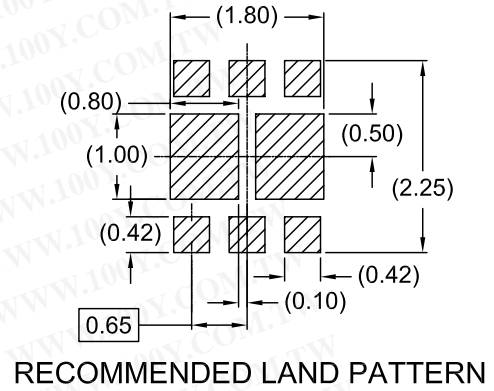
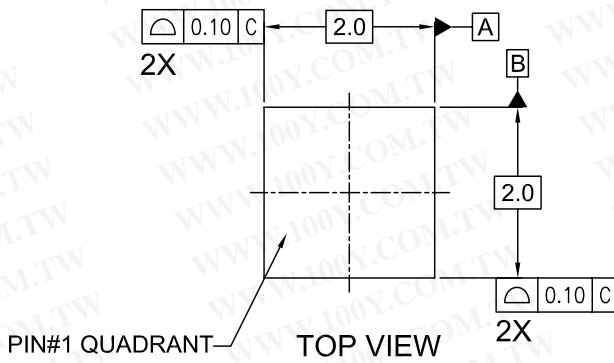

Figure 11. Transient Thermal Response Curve

Dimensional Outline and Pad Layout



NOTES:

- A. CONFORMS TO JEDEC REGISTRATION MO-229, VARIATION VCCC EXCEPT AS NOTED.
- B. DIMENSIONS ARE IN MILLIMETERS.
- C. DIMENSIONS AND TOLERANCES PER ASME Y14.5M, 1994
- D. NON-JEDEC DUAL DAP
- E. DRAWING FILE NAME : MLP06J rev3

TRADEMARKS

The following includes registered and unregistered trademarks and service marks, owned by Fairchild Semiconductor and/or its global subsidiaries, and is not intended to be an exhaustive list of all such trademarks.

- | | | | |
|---|---|--|---|
| Auto-SPM™ | F-PFST™ | PowerTrench® | The Power Franchise® |
| Build it Now™ | FRFET® | PowerXS™ | the pwer® |
| CorePLUS™ | Global Power Resource SM | Programmable Active Droop™ | franchise |
| CorePOWER™ | Green FPS™ | QFET® | TinyBoost™ |
| CROSSVOLT™ | Green FPS™ e-Series™ | QS™ | TinyBuck™ |
| CTL™ | Gmax™ | Quiet Series™ | TinyLogic® |
| Current Transfer Logic™ | GTO™ | RapidConfigure™ | TINYOPTO™ |
| EcoSPARK® | IntelliMAX™ |  ™ | TinyPower™ |
| EfficientMax™ | ISOPLANAR™ | Saving our world, 1mW /W /kW at a time™ | TinyPWM™ |
| EZSWITCH™ * | MegaBuck™ | SmartMax™ | TinyWire™ |
|  | MICROCOUPLER™ | SMART START™ | TriFault Detect™ |
|  | MicroFET™ | SPM® | TRUECURRENT™* |
| Fairchild® | MicroPak™ | STEALTH™ | μSerDes™ |
| Fairchild Semiconductor® | MillerDrive™ | SuperFET™ |  |
| FACT Quiet Series™ | MotionMax™ | SuperSOT™-3 | UHC® |
| FACT® | Motion-SPM™ | SuperSOT™-6 | Ultra FRFET™ |
| FAST® | OPTOLOGIC® | SuperSOT™-8 | UniFET™ |
| FAST® | OPTOPLANAR® | SupreMOS™ | VCX™ |
| FastvCore™ |  | SyncFET™ | VisualMax™ |
| FETBench™ | PDP SPM™ | Sync-Lock™ | XS™ |
| FlashWriter® * | Power-SPM™ |  SYSTEM GENERAL®* | |
| FPS™ | | | |

*Trademarks of System General Corporation, used under license by Fairchild Semiconductor.

DISCLAIMER

FAIRCHILD SEMICONDUCTOR RESERVES THE RIGHT TO MAKE CHANGES WITHOUT FURTHER NOTICE TO ANY PRODUCTS HEREIN TO IMPROVE RELIABILITY, FUNCTION, OR DESIGN. FAIRCHILD DOES NOT ASSUME ANY LIABILITY ARISING OUT OF THE APPLICATION OR USE OF ANY PRODUCT OR CIRCUIT DESCRIBED HEREIN; NEITHER DOES IT CONVEY ANY LICENSE UNDER ITS PATENT RIGHTS, NOR THE RIGHTS OF OTHERS. THESE SPECIFICATIONS DO NOT EXPAND THE TERMS OF FAIRCHILD'S WORLDWIDE TERMS AND CONDITIONS, SPECIFICALLY THE WARRANTY THEREIN, WHICH COVERS THESE PRODUCTS.

LIFE SUPPORT POLICY

FAIRCHILD'S PRODUCTS ARE NOT AUTHORIZED FOR USE AS CRITICAL COMPONENTS IN LIFE SUPPORT DEVICES OR SYSTEMS WITHOUT THE EXPRESS WRITTEN APPROVAL OF FAIRCHILD SEMICONDUCTOR CORPORATION.

As used herein:

- Life support devices or systems are devices or systems which, (a) are intended for surgical implant into the body or (b) support or sustain life, and (c) whose failure to perform when properly used in accordance with instructions for use provided in the labeling, can be reasonably expected to result in a significant injury of the user.
- A critical component in any component of a life support, device, or system whose failure to perform can be reasonably expected to cause the failure of the life support device or system, or to affect its safety or effectiveness.

ANTI-COUNTERFEITING POLICY

Fairchild Semiconductor Corporation's Anti-Counterfeiting Policy. Fairchild's Anti-Counterfeiting Policy is also stated on our external website, www.Fairchildsemi.com, under Sales Support.

Counterfeiting of semiconductor parts is a growing problem in the industry. All manufactures of semiconductor products are experiencing counterfeiting of their parts. Customers who inadvertently purchase counterfeit parts experience many problems such as loss of brand reputation, substandard performance, failed application, and increased cost of production and manufacturing delays. Fairchild is taking strong measures to protect ourselves and our customers from the proliferation of counterfeit parts. Fairchild strongly encourages customers to purchase Fairchild parts either directly from Fairchild or from Authorized Fairchild Distributors who are listed by country on our web page cited above. Products customers buy either from Fairchild directly or from Authorized Fairchild Distributors are genuine parts, have full traceability, meet Fairchild's quality standards for handling and storage and provide access to Fairchild's full range of up-to-date technical and product information. Fairchild and our Authorized Distributors will stand behind all warranties and will appropriately address and warranty issues that may arise. Fairchild will not provide any warranty coverage or other assistance for parts bought from Unauthorized Sources. Fairchild is committed to combat this global problem and encourage our customers to do their part in stopping this practice by buying direct or from authorized distributors.

PRODUCT STATUS DEFINITIONS

Definition of Terms

Datasheet Identification	Product Status	Definition
Advance Information	Formative / In Design	Datasheet contains the design specifications for product development. Specifications may change in any manner without notice.
Preliminary	First Production	Datasheet contains preliminary data; supplementary data will be published at a later date. Fairchild Semiconductor reserves the right to make changes at any time without notice to improve design.
No Identification Needed	Full Production	Datasheet contains final specifications. Fairchild Semiconductor reserves the right to make changes at any time without notice to improve the design.
Obsolete	Not In Production	Datasheet contains specifications on a product that is discontinued by Fairchild Semiconductor. The datasheet is for reference information only.

Rev. 140