

FDMB668P

P-Channel 1.8V Logic Level PowerTrench® MOSFET -20V, -6.1A, 35mΩ

Features

- Max $r_{DS(on)}$ = 35mΩ at $V_{GS} = -4.5V$, $I_D = -6.1A$
- Max $r_{DS(on)}$ = 50mΩ at $V_{GS} = -2.5V$, $I_D = -5.1A$
- Max $r_{DS(on)}$ = 70mΩ at $V_{GS} = -1.8V$, $I_D = -4.3A$
- Excellent for portable application at $V_{GS} = -1.8V$
- Thin profile - Maximum height = 0.8mm
- RoHS compliant



General Description

FDMB668P is excellent for load switch and DC-DC conversion among portable electronics. It achieves an optimal balance among efficiency, thermal transfer and small form by integrating a P-channel MOSFET with minimized on-state resistance into a MicroFET 3x1.9 package. When optimizing the dimension of portable applications, this little device offers a very efficient solution.

Applications

- Load Switch in:
 - HDD
 - Portable Gaming, MP3
 - Notebook
- DC/DC Conversion

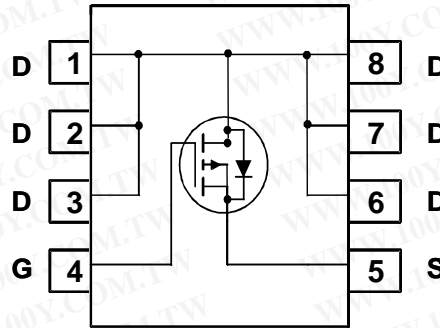
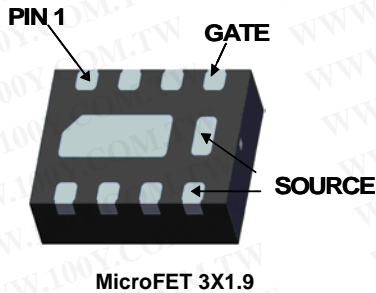

MOSFET Maximum Ratings $T_A = 25^\circ\text{C}$ unless otherwise noted

Symbol	Parameter	Ratings	Units
V_{DS}	Drain to Source Voltage	-20	V
V_{GS}	Gate to Source Voltage	±8	V
I_D	Drain Current -Continuous	(Note 1a)	-6.1
	-Pulsed		-40
P_D	Power Dissipation	(Note 1a)	1.9
	Power Dissipation	(Note 1b)	0.8
T_J, T_{STG}	Operating and Storage Junction Temperature Range	-55 to +150	°C

Thermal Characteristics

$R_{\theta JA}$	Thermal Resistance, Junction to Ambient	(Note 1a)	65	°C/W
$R_{\theta JA}$	Thermal Resistance, Junction to Ambient	(Note 1b)	165	

Package Marking and Ordering Information

Device Marking	Device	Package	Reel Size	Tape Width	Quantity
668	FDMB668P	MicroFET 3X1.9	7"	8mm	3000 units

Electrical Characteristics $T_J = 25^\circ\text{C}$ unless otherwise noted

Symbol	Parameter	Test Conditions	Min	Typ	Max	Units
--------	-----------	-----------------	-----	-----	-----	-------

Off Characteristics

BV_{DSS}	Drain to Source Breakdown Voltage	$I_D = -250\mu\text{A}$, $V_{GS} = 0\text{V}$	-20			V
$\frac{\Delta BV_{DSS}}{\Delta T_J}$	Breakdown Voltage Temperature Coefficient	$I_D = -250\mu\text{A}$, referenced to 25°C		-11.4		mV/ $^\circ\text{C}$
I_{DSS}	Zero Gate Voltage Drain Current	$V_{DS} = -16\text{V}$, $V_{GS} = 0\text{V}$			-1	μA
I_{GSS}	Gate to Source Leakage Current	$V_{GS} = \pm 8\text{V}$, $V_{DS} = 0\text{V}$			± 100	nA

On Characteristics (Note 2)

$V_{GS(th)}$	Gate to Source Threshold Voltage	$V_{GS} = V_{DS}$, $I_D = -250\mu\text{A}$	-0.4	-0.6	-1.0	V
$\frac{\Delta V_{GS(th)}}{\Delta T_J}$	Gate to Source Threshold Voltage Temperature Coefficient	$I_D = -250\mu\text{A}$, referenced to 25°C		2.8		mV/ $^\circ\text{C}$
$r_{DS(on)}$	Static Drain to Source On Resistance	$V_{GS} = -4.5\text{V}$, $I_D = -6.1\text{A}$		22	35	m Ω
		$V_{GS} = -2.5\text{V}$, $I_D = -5.1\text{A}$		27	50	
		$V_{GS} = -1.8\text{V}$, $I_D = -4.3\text{A}$		35	70	
		$V_{GS} = -4.5\text{V}$, $I_D = -6.1\text{A}$, $T_J = 125^\circ\text{C}$		31	50	
g_{FS}	Forward Transconductance	$V_{DS} = -4.5\text{V}$, $I_D = -6.1\text{A}$		27		S

Dynamic Characteristics

C_{iss}	Input Capacitance	$V_{DS} = -10\text{V}$, $V_{GS} = 0\text{V}$, $f = 1\text{MHz}$		1565	2085	pF
C_{oss}	Output Capacitance			210	280	pF
C_{rss}	Reverse Transfer Capacitance			175	265	pF

Switching Characteristics

$t_{d(on)}$	Turn-On Delay Time	$V_{DD} = -10\text{V}$, $I_D = -6.1\text{A}$ $V_{GS} = -4.5\text{V}$, $R_{GEN} = 6\Omega$		7	14	ns
t_r	Rise Time			9	18	ns
$t_{d(off)}$	Turn-Off Delay Time			176	282	ns
t_f	Fall Time			84	135	ns
Q_g	Total Gate Charge		$V_{GS} = 0\text{V to } -10\text{V}$	$V_{DD} = -10\text{V}$ $I_D = -6.1\text{A}$	42	59
Q_g	Total Gate Charge	$V_{GS} = 0\text{V to } -5\text{V}$	22		31	nC
Q_{gs}	Gate to Source Gate Charge		3			nC
Q_{gd}	Gate to Drain "Miller" Charge		5			nC

Drain-Source Diode Characteristics

V_{SD}	Source to Drain Diode Forward Voltage	$V_{GS} = 0\text{V}$, $I_S = -1.6\text{A}$ (Note 2)		-0.7	-1.2	V
t_{rr}	Reverse Recovery Time	$I_F = -6.1\text{A}$, $di/dt = 100\text{A}/\mu\text{s}$		29	44	ns
Q_{rr}	Reverse Recovery Charge			15	23	nC

Notes:

- 1: $R_{\theta JA}$ is the sum of the junction-to-case and case-to-ambient thermal resistance where the case thermal reference is defined as the solder mounting surface of the drain pins. $R_{\theta JC}$ is guaranteed by design while $R_{\theta JA}$ is determined by the user's board design.

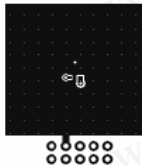

a) $65^\circ\text{C}/\text{W}$ when mounted on a 1in^2 pad of 2 oz copper



b) $165^\circ\text{C}/\text{W}$ when mounted on a minimum pad.

2: Pulse Test: Pulse Width < 300 us, Duty Cycle < 2%.

Typical Characteristics $T_J = 25^\circ\text{C}$ unless otherwise noted

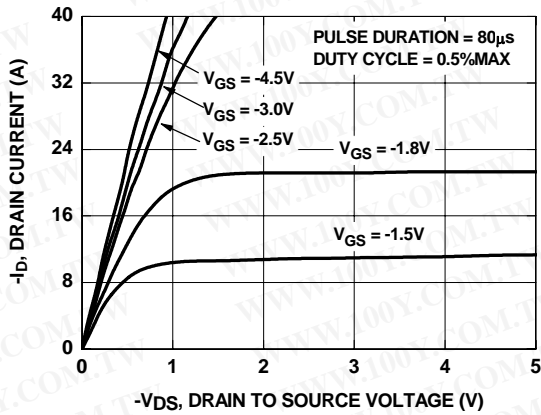

Figure 1. On-Region Characteristics

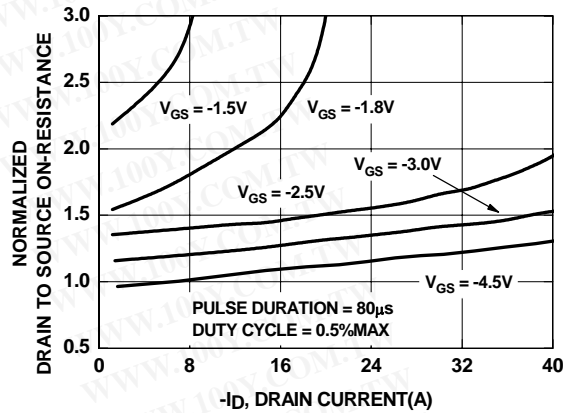

Figure 2. Normalized On-Resistance vs Drain Current and Gate Voltage

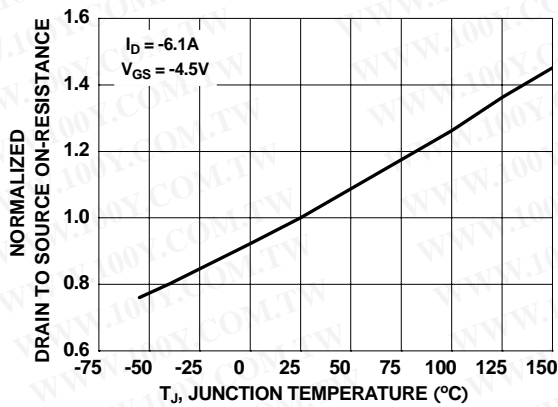

Figure 3. Normalized On-Resistance vs Junction Temperature

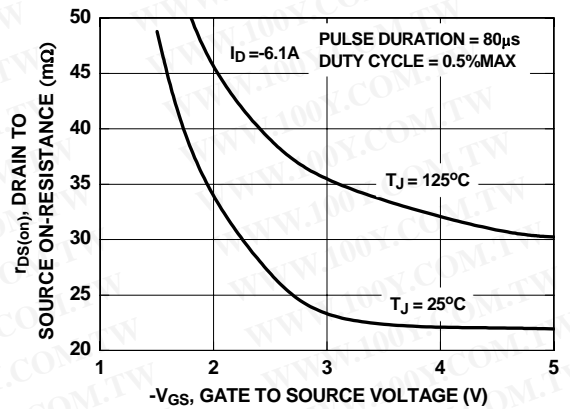

Figure 4. On-Resistance vs Gate to Source Voltage

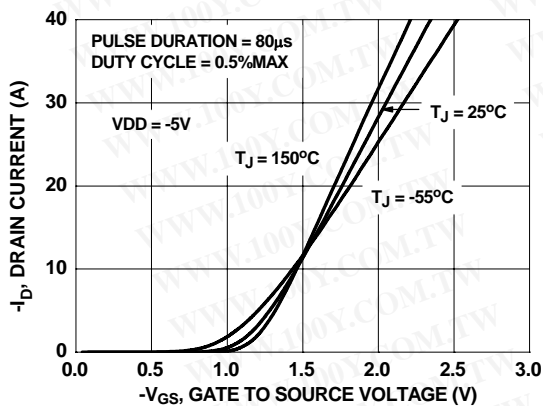

Figure 5. Transfer Characteristics

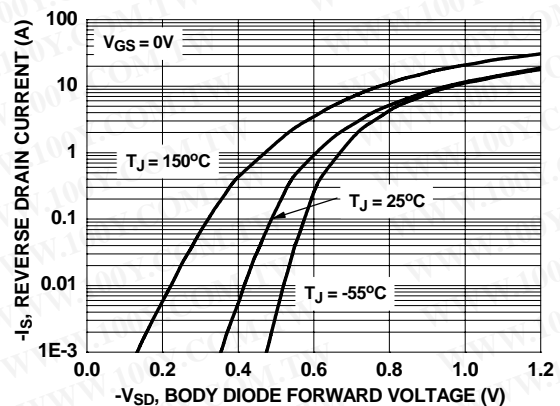

Figure 6. Source to Drain Diode Forward Voltage vs Source Current

Typical Characteristics $T_J = 25^\circ\text{C}$ unless otherwise noted

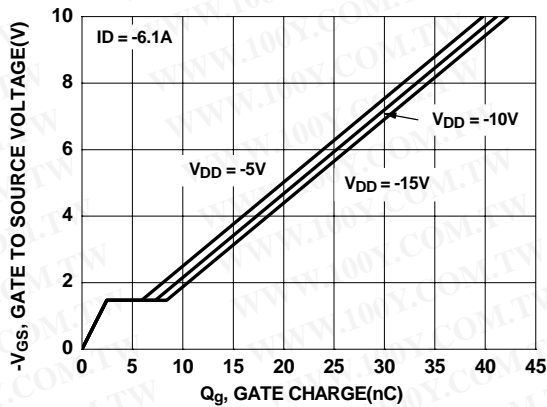

Figure 7. Gate Charge Characteristics

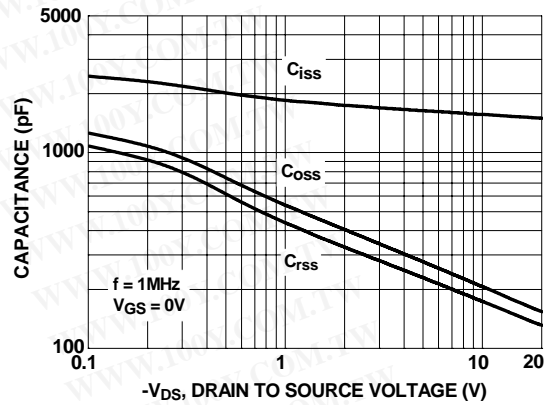

Figure 8. Capacitance vs Drain to Source Voltage

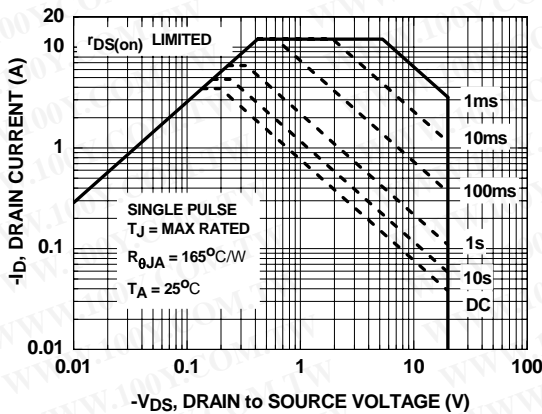

Figure 9. Forward Bias Safe Operating Area

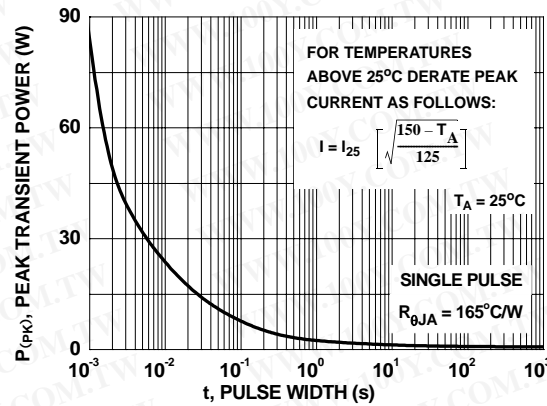

Figure 10. Single Pulse Maximum Power Dissipation

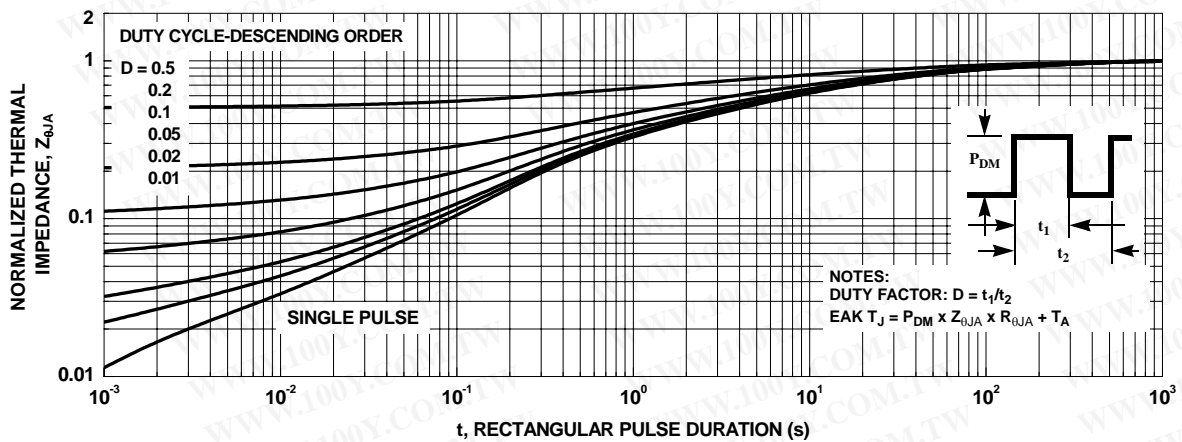
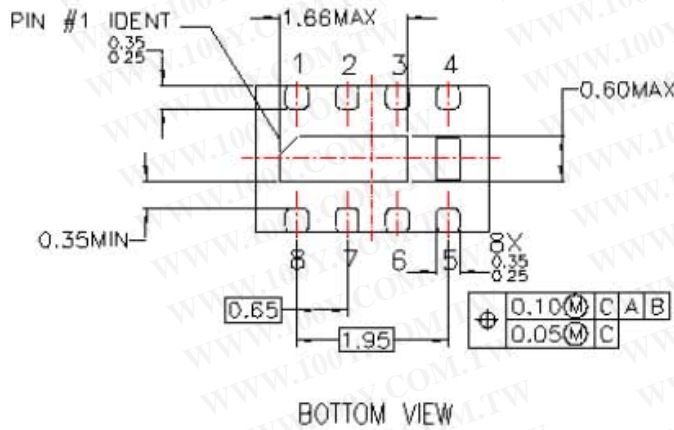
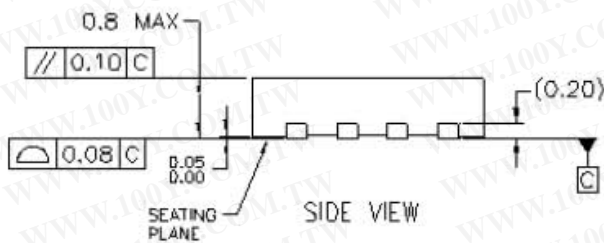
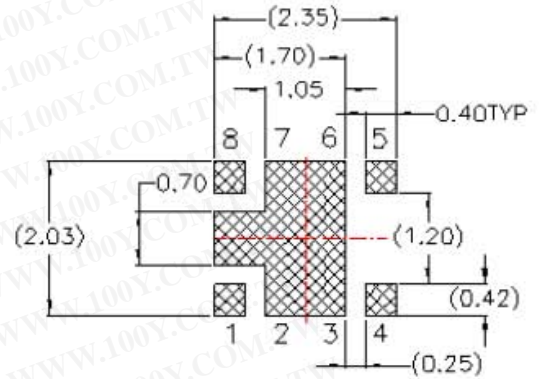
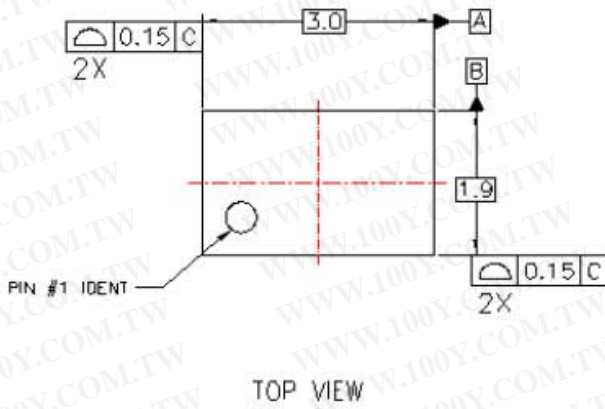

Figure 11. Transient Thermal Response Curve

Dimensional Outline and Pad Layout



MLP081revA

FDMB668P P-Channel 1.8V Logic Level PowerTrench[®] MOSFET

TRADEMARKS

The following are registered and unregistered trademarks Fairchild Semiconductor owns or is authorized to use and is not intended to be an exhaustive list of all such trademarks.

- | | | | | |
|----------------------------------|--|---------------------------------|------------------------------|---------------------|
| ACE _x [™] | FACT Quiet Series [™] | OCX [™] | SILENT SWITCHER [®] | UniFET [™] |
| ActiveArray [™] | GlobalOptoisolator [™] | OCXPro [™] | SMART START [™] | VCX [™] |
| Bottomless [™] | GTO [™] | OPTOLOGIC [®] | SPM [™] | Wire [™] |
| Build it Now [™] | HiSeC [™] | OPTOPLANAR [™] | Stealth [™] | |
| CoolFET [™] | I ² C [™] | PACMAN [™] | SuperFET [™] | |
| CROSSVOLT [™] | i-Lo [™] | POP [™] | SuperSOT [™] -3 | |
| DOMET [™] | ImpliedDisconnect [™] | Power247 [™] | SuperSOT [™] -6 | |
| EcoSPARK [™] | IntelliMAX [™] | PowerEdge [™] | SuperSOT [™] -8 | |
| E ² CMOS [™] | ISOPLANAR [™] | PowerSaver [™] | SyncFET [™] | |
| EnSigna [™] | LittleFET [™] | PowerTrench [®] | TCM [™] | |
| FACT [®] | MICROCOUPLER [™] | QFET [®] | TinyBoost [™] | |
| FAST [®] | MicroFET [™] | QS [™] | TinyBuck [™] | |
| FASTr [™] | MicroPak [™] | QT Optoelectronics [™] | TinyPWM [™] | |
| FPS [™] | MICROWIRE [™] | Quiet Series [™] | TinyPower [™] | |
| FRFET [™] | MSX [™] | RapidConfigure [™] | TinyLogic [®] | |
| | MSXPro [™] | RapidConnect [™] | TINYOPTO [™] | |
| | Across the board. Around the world. [™] | μSerDes [™] | TruTranslation [™] | |
| | The Power Franchise [®] | ScalarPump [™] | UHC [®] | |
| | Programmable Active Droop [™] | | | |

DISCLAIMER

FAIRCHILD SEMICONDUCTOR RESERVES THE RIGHT TO MAKE CHANGES WITHOUT FURTHER NOTICE TO ANY PRODUCTS HEREIN TO IMPROVE RELIABILITY, FUNCTION OR DESIGN. FAIRCHILD DOES NOT ASSUME ANY LIABILITY ARISING OUT OF THE APPLICATION OR USE OF ANY PRODUCT OR CIRCUIT DESCRIBED HEREIN; NEITHER DOES IT CONVEY ANY LICENSE UNDER ITS PATENT RIGHTS, NOR THE RIGHTS OF OTHERS. THESE SPECIFICATIONS DO NOT EXPAND THE TERMS OF FAIRCHILD'S WORLDWIDE TERMS AND CONDITIONS, SPECIFICALLY THE WARRANTY THEREIN, WHICH COVERS THESE PRODUCTS.

LIFE SUPPORT POLICY

FAIRCHILD'S PRODUCTS ARE NOT AUTHORIZED FOR USE AS CRITICAL COMPONENTS IN LIFE SUPPORT DEVICES OR SYSTEMS WITHOUT THE EXPRESS WRITTEN APPROVAL OF FAIRCHILD SEMICONDUCTOR CORPORATION.

As used herein:

1. Life support devices or systems are devices or systems which, (a) are intended for surgical implant into the body, or (b) support or sustain life, or (c) whose failure to perform when properly used in accordance with instructions for use provided in the labeling, can be reasonably expected to result in significant injury to the user.
2. A critical component is any component of a life support device or system whose failure to perform can be reasonably expected to cause the failure of the life support device or system, or to affect its safety or effectiveness.

PRODUCT STATUS DEFINITIONS

Definition of Terms

Datasheet Identification	Product Status	Definition
Advance Information	Formative or In Design	This datasheet contains the design specifications for product development. Specifications may change in any manner without notice.
Preliminary	First Production	This datasheet contains preliminary data, and supplementary data will be published at a later date. Fairchild Semiconductor reserves the right to make changes at any time without notice in order to improve design.
No Identification Needed	Full Production	This datasheet contains final specifications. Fairchild Semiconductor reserves the right to make changes at any time without notice in order to improve design.
Obsolete	Not In Production	This datasheet contains specifications on a product that has been discontinued by Fairchild semiconductor. The datasheet is printed for reference information only.

Rev. 122