



# FDZ7296

## 30V N-Channel PowerTrench® BGA MOSFET

### General Description

Combining Fairchild's advanced PowerTrench process with state-of-the-art BGA packaging, the FDZ7296 minimizes both PCB space and  $R_{DS(ON)}$ . This BGA MOSFET embodies a breakthrough in packaging technology which enables the device to combine excellent thermal transfer characteristics, high current handling capability, ultra-low profile packaging, low gate charge, and low  $R_{DS(ON)}$ .

### Applications

- High-side Mosfet in DC-DC converters for Server and Notebook applications
- RoHS Compliant



### Features

11 A, 30 V.  $R_{DS(ON)} = 8.5 \text{ m}\Omega @ V_{GS} = 10 \text{ V}$   
 $R_{DS(ON)} = 12 \text{ m}\Omega @ V_{GS} = 4.5 \text{ V}$

- Occupies only  $0.10 \text{ cm}^2$  of PCB area: 1/3 the area of SO-8.
- Ultra-thin package: less than 0.80 mm height when mounted to PCB.
- High performance trench technology for extremely low  $R_{DS(ON)}$
- Optimized for low  $Q_g$  and  $Q_{gd}$  to enable fast switching and reduce  $CdV/dt$  gate coupling

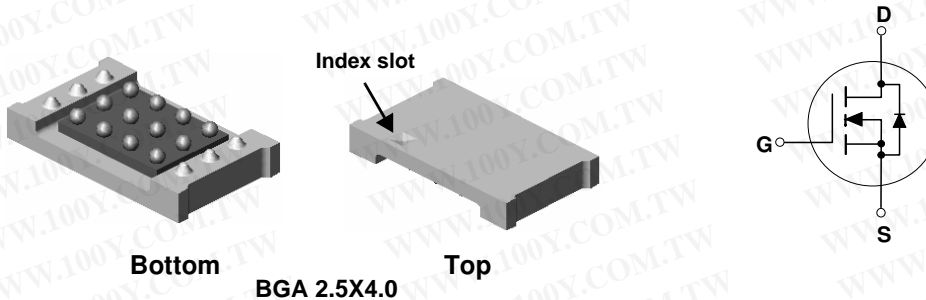

### Absolute Maximum Ratings $T_A=25^\circ\text{C}$ unless otherwise noted

Symbol	Parameter	Ratings	Units
$V_{DSS}$	Drain-Source Voltage	30	V
$V_{GSS}$	Gate-Source Voltage	$\pm 20$	V
$I_D$	Drain Current – Continuous (Note 1a)	11	A
		20	
$P_D$	Power Dissipation (Steady State) (Note 1a)	2.1	W
$T_J, T_{STG}$	Operating and Storage Junction Temperature Range	-55 to +150	$^\circ\text{C}$

### Thermal Characteristics

$R_{\theta JA}$	Thermal Resistance, Junction-to-Ambient (Note 1a)	60	$^\circ\text{C/W}$
$R_{\theta JB}$	Thermal Resistance, Junction-to-Ball (Note 1)	6.3	
$R_{\theta JC}$	Thermal Resistance, Junction-to-Case (Note 1)	0.6	

### Package Marking and Ordering Information

Device Marking	Device	Reel Size	Tape width	Quantity
7296	FDZ7296	7"	8mm	3000 units

## Electrical Characteristics

T<sub>A</sub> = 25 °C unless otherwise noted

Symbol	Parameter	Test Conditions	Min	Typ	Max	Units
<b>Off Characteristics</b>						
BV <sub>DSS</sub>	Drain-Source Breakdown Voltage	V <sub>GS</sub> = 0 V, I <sub>D</sub> = 250 μA	30			V
ΔBV <sub>DSS</sub> ΔT <sub>J</sub>	Breakdown Voltage Temperature Coefficient	I <sub>D</sub> = 250 μA, Referenced to 25°C		27		mV/°C
I <sub>DSS</sub>	Zero Gate Voltage Drain Current	V <sub>DS</sub> = 24 V, V <sub>GS</sub> = 0 V			1	μA
I <sub>GSS</sub>	Gate-Body Leakage	V <sub>GS</sub> = ±20 V, V <sub>DS</sub> = 0 V			±100	nA

### On Characteristics (Note 2)

V <sub>GS(th)</sub>	Gate Threshold Voltage	V <sub>DS</sub> = V <sub>GS</sub> , I <sub>D</sub> = 250 μA	1	1.8	3	V
ΔV <sub>GS(th)</sub> ΔT <sub>J</sub>	Gate Threshold Voltage Temperature Coefficient	I <sub>D</sub> = 250 μA, Referenced to 25°C		-4.9		mV/°C
R <sub>DS(on)</sub>	Static Drain-Source On-Resistance	V <sub>GS</sub> = 10 V, I <sub>D</sub> = 11 A V <sub>GS</sub> = 4.5V, I <sub>D</sub> = 10 A V <sub>GS</sub> = 10 V, I <sub>D</sub> = 11 A, T <sub>J</sub> = 125°C		7 9 9.1	8.5 12 13	mΩ

### Dynamic Characteristics

C <sub>iss</sub>	Input Capacitance	V <sub>DS</sub> = 15 V, V <sub>GS</sub> = 0 V, f = 1.0 MHz		1520		pF
C <sub>oss</sub>	Output Capacitance			420		pF
C <sub>rss</sub>	Reverse Transfer Capacitance			130		pF
g <sub>FS</sub>	Forward Transconductance	V <sub>DS</sub> = 5 V, I <sub>D</sub> = 11 A		46		S
R <sub>G</sub>	Gate Resistance	V <sub>GS</sub> = 15 mV, f = 1.0 MHz		1.1		Ω

### Switching Characteristics (Note 2)

t <sub>d(on)</sub>	Turn-On Delay Time	V <sub>DD</sub> = 15 V, I <sub>D</sub> = 1 A, V <sub>GS</sub> = 10 V, R <sub>GEN</sub> = 6 Ω		10	20	ns
t <sub>r</sub>	Turn-On Rise Time			4	8	ns
t <sub>d(off)</sub>	Turn-Off Delay Time			27	43	ns
t <sub>f</sub>	Turn-Off Fall Time			13	23	ns
Q <sub>g(TOT)</sub>	Total Gate Charge at V <sub>gs</sub> =10V	V <sub>DD</sub> = 15 V, I <sub>D</sub> = 11 A,		22	31	nC
Q <sub>g</sub>	Total Gate Charge at V <sub>gs</sub> =5V			12	17	nC
Q <sub>gs</sub>	Gate-Source Charge			4.5		nC
Q <sub>gd</sub>	Gate-Drain Charge			3.1		nC

### Drain-Source Diode Characteristics and Maximum Ratings

I <sub>S</sub>	Maximum Continuous Drain-Source Diode Forward Current			1.7		A
V <sub>SD</sub>	Drain-Source Diode Forward Voltage	V <sub>GS</sub> = 0 V, I <sub>S</sub> = 1.7 A (Note 2)		0.7	1.2	V
t <sub>rr</sub>	Diode Reverse Recovery Time	I <sub>F</sub> = 11 A		28		nS
Q <sub>rr</sub>	Diode Reverse Recovery Charge	d <sub>I</sub> /d <sub>t</sub> = 100 A/μs (Note 2)		18		nC

#### Notes:

- R<sub>θJA</sub> is determined with the device mounted on a 1 in<sup>2</sup> 2 oz. copper pad on a 1.5 x 1.5 in. board of FR-4 material. The thermal resistance from the junction to the circuit board side of the solder ball, R<sub>θJB</sub>, is defined for reference. For R<sub>θJC</sub>, the thermal reference point for the case is defined as the top surface of the copper chip carrier. R<sub>θJC</sub> and R<sub>θJB</sub> are guaranteed by design while R<sub>θJA</sub> is determined by the user's board design.



- a) 60 °C/W when mounted on a 1in<sup>2</sup> pad of 2 oz copper, 1.5" x 1.5" x 0.062" thick PCB

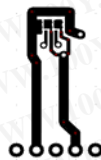

- b) 108 °C/W when mounted on a minimum pad of 2 oz copper

Scale 1 : 1 on letter size paper

- Pulse Test: Pulse Width < 300μs, Duty Cycle < 2.0%

# Dimensional Outline and Pad Layout

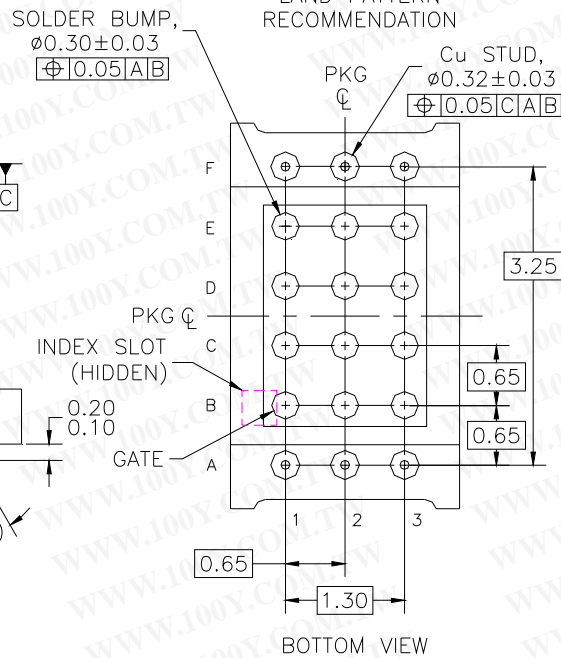
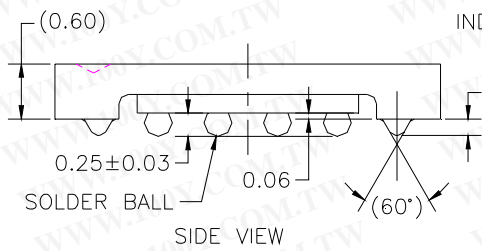
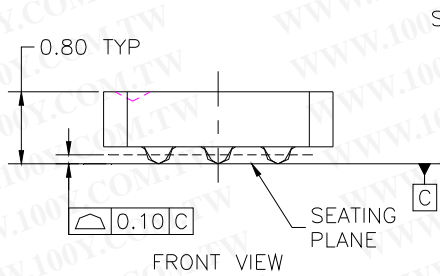
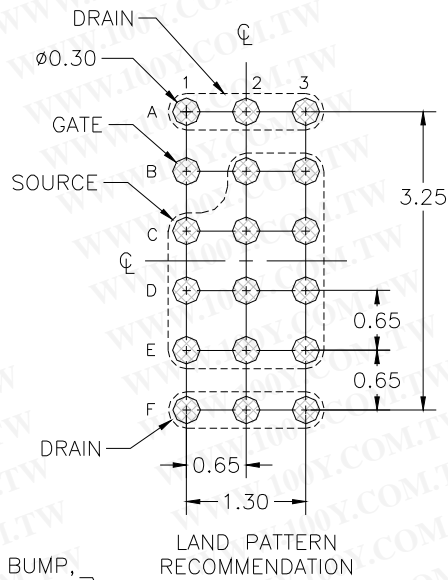
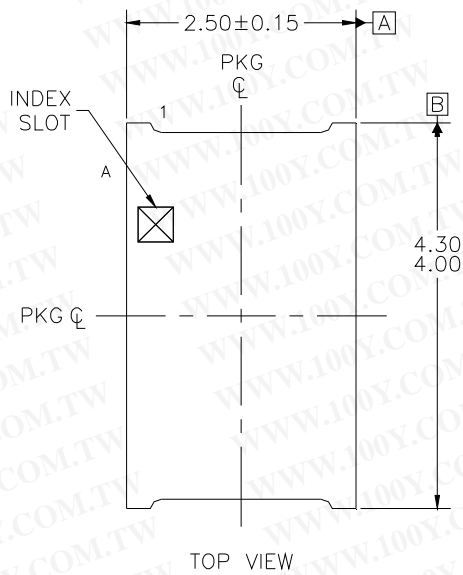

NOTES: UNLESS OTHERWISE SPECIFIED

- A) ALL DIMENSIONS ARE IN MILLIMETERS.
- B) NO JEDEC REGISTRATION REFERENCE AS OF JULY 1999.
- C) BALL CONFIGURATION TABLE

TERMINAL	DESIGNATION
A1,A2,A3,F1,F2,F3	DRAIN
B1	GATE
B2,B3,C1,C2,C3, D1,D2,D3,E1,E2,E3	SOURCE

FDZ7296 30V N-Channel PowerTrench® BGA MOSFET

## Typical Characteristics

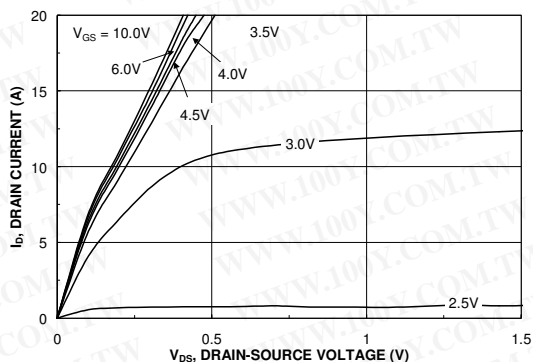

Figure 1. On-Region Characteristics.

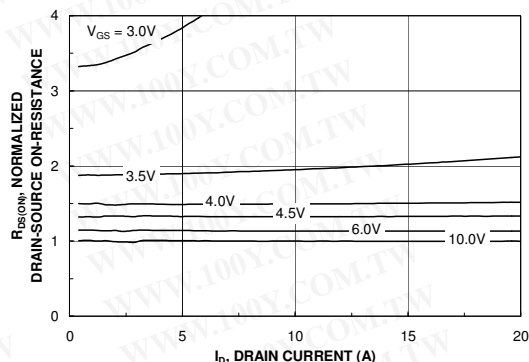

Figure 2. On-Resistance Variation with Drain Current and Gate Voltage.

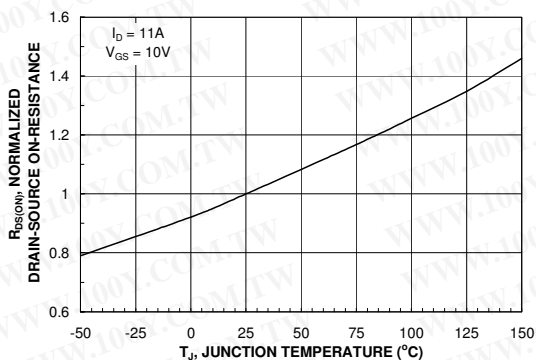

Figure 3. On-Resistance Variation with Temperature.

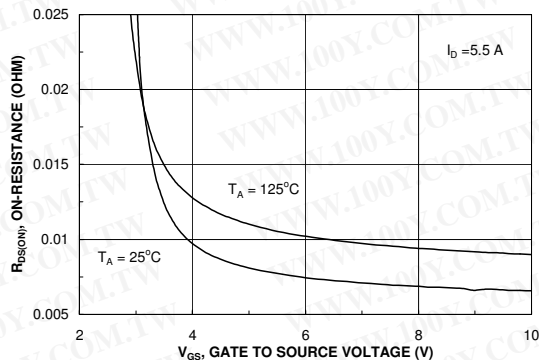

Figure 4. On-Resistance Variation with Gate-to-Source Voltage.

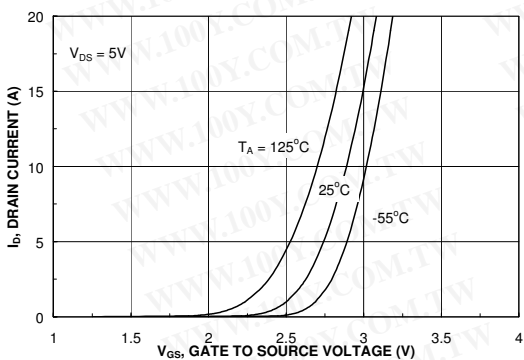

Figure 5. Transfer Characteristics.

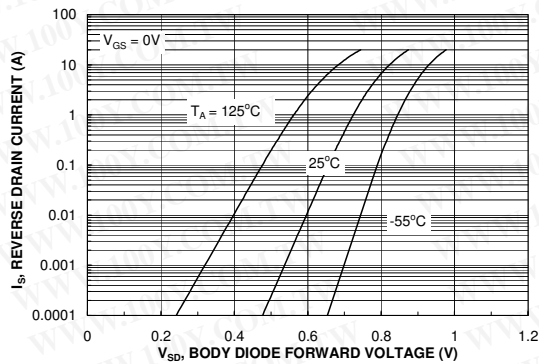

Figure 6. Body Diode Forward Voltage Variation with Source Current and Temperature.

### Typical Characteristics

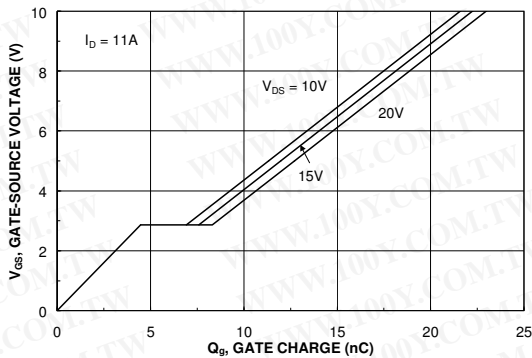

Figure 7. Gate Charge Characteristics.

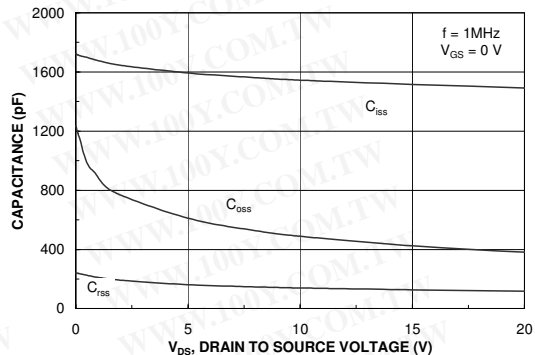

Figure 8. Capacitance Characteristics.

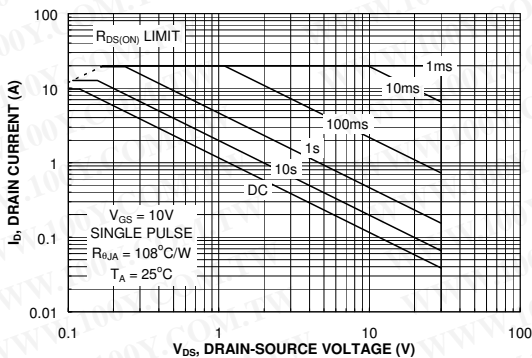

Figure 9. Maximum Safe Operating Area.

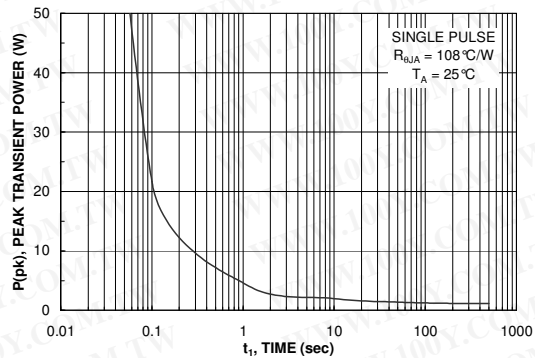

Figure 10. Single Pulse Maximum Power Dissipation.

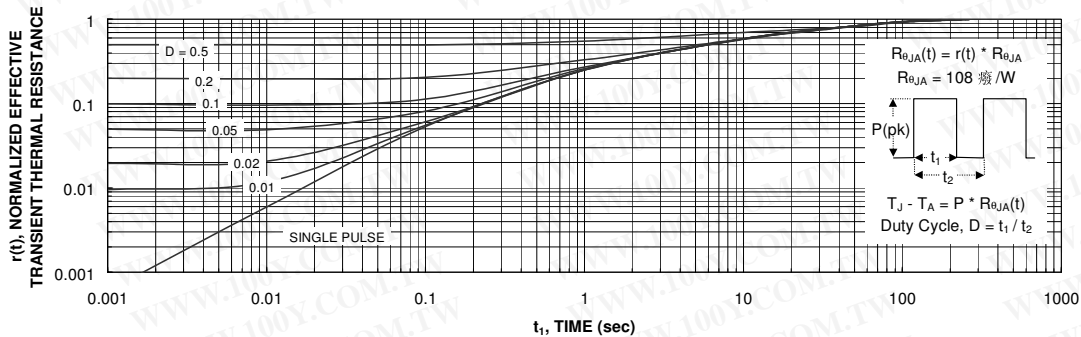

Figure 11. Transient Thermal Response Curve.

Thermal characterization performed using the conditions described in Note 1b. Transient thermal response will change depending on the circuit board design.

## TRADEMARKS

The following are registered and unregistered trademarks and service marks Fairchild Semiconductor owns or is authorized to use and is not intended to be an exhaustive list of all such trademarks.

ACEx <sup>®</sup>	Green FPS <sup>™</sup>	Power247 <sup>®</sup>	SuperSOT <sup>™</sup> -8
Build it Now <sup>™</sup>	Green FPS <sup>™</sup> e-Series <sup>™</sup>	POWEREDGE <sup>®</sup>	SyncFET <sup>™</sup>
CorePLUS <sup>™</sup>	GTO <sup>™</sup>	Power-SPM <sup>™</sup>	The Power Franchise <sup>®</sup>
CROSSVOLT <sup>™</sup>	<i>i-Lo</i> <sup>™</sup>	PowerTrench <sup>®</sup>	<b>p</b> .wer <sup>®</sup>
CTL <sup>™</sup>	IntelliMAX <sup>™</sup>	Programmable Active Droop <sup>™</sup>	the franchise
Current Transfer Logic <sup>™</sup>	ISOPLANAR <sup>™</sup>	QFET <sup>®</sup>	TinyBoost <sup>™</sup>
EcoSPARK <sup>®</sup>	MegaBuck <sup>™</sup>	QS <sup>™</sup>	TinyBuck <sup>™</sup>
<b>F</b> <sup>®</sup>	MICROCOUPLER <sup>™</sup>	QT Optoelectronics <sup>™</sup>	TinyLogic <sup>®</sup>
Fairchild <sup>®</sup>	MicroFET <sup>™</sup>	Quiet Series <sup>™</sup>	TINYOPTO <sup>™</sup>
Fairchild Semiconductor <sup>®</sup>	MicroPak <sup>™</sup>	RapidConfigure <sup>™</sup>	TinyPower <sup>™</sup>
FACT Quiet Series <sup>™</sup>	Motion-SPM <sup>™</sup>	SMART START <sup>™</sup>	TinyPWM <sup>™</sup>
FACT <sup>®</sup>	OPTOLOGIC <sup>®</sup>	SPM <sup>®</sup>	TinyWire <sup>™</sup>
FAST <sup>®</sup>	OPTOPLANAR <sup>®</sup>	STEALTH <sup>™</sup>	µSerDes <sup>™</sup>
FastvCore <sup>™</sup>		SuperFET <sup>™</sup>	UHC <sup>®</sup>
FPS <sup>™</sup>	PDP-SPM <sup>™</sup>	SuperSOT <sup>™</sup> -3	UniFET <sup>™</sup>
FRFET <sup>®</sup>	Power220 <sup>®</sup>	SuperSOT <sup>™</sup> -6	VCX <sup>™</sup>
Global Power Resource <sup>SM</sup>			

## DISCLAIMER

FAIRCHILD SEMICONDUCTOR RESERVES THE RIGHT TO MAKE CHANGES WITHOUT FURTHER NOTICE TO ANY PRODUCTS HEREIN TO IMPROVE RELIABILITY, FUNCTION, OR DESIGN. FAIRCHILD DOES NOT ASSUME ANY LIABILITY ARISING OUT OF THE APPLICATION OR USE OF ANY PRODUCT OR CIRCUIT DESCRIBED HEREIN; NEITHER DOES IT CONVEY ANY LICENSE UNDER ITS PATENT RIGHTS, NOR THE RIGHTS OF OTHERS. THESE SPECIFICATIONS DO NOT EXPAND THE TERMS OF FAIRCHILD'S WORLDWIDE TERMS AND CONDITIONS, SPECIFICALLY THE WARRANTY THEREIN, WHICH COVERS THESE PRODUCTS.

## LIFE SUPPORT POLICY

FAIRCHILD'S PRODUCTS ARE NOT AUTHORIZED FOR USE AS CRITICAL COMPONENTS IN LIFE SUPPORT DEVICES OR SYSTEMS WITHOUT THE EXPRESS WRITTEN APPROVAL OF FAIRCHILD SEMICONDUCTOR CORPORATION.

As used herein:

1. Life support devices or systems are devices or systems which, (a) are intended for surgical implant into the body, or (b) support or sustain life, and (c) whose failure to perform when properly used in accordance with instructions for use provided in the labeling, can be reasonably expected to result in significant injury to the user.
2. A critical component is any component of a life support device or system whose failure to perform can be reasonably expected to cause the failure of the life support device or system, or to affect its safety or effectiveness.

## PRODUCT STATUS DEFINITIONS

### Definition of Terms

Datasheet Identification	Product Status	Definition
Advance Information	Formative or In Design	This datasheet contains the design specifications for product development. Specifications may change in any manner without notice.
Preliminary	First Production	This datasheet contains preliminary data; supplementary data will be published at a later date. Fairchild Semiconductor reserves the right to make changes at any time without notice to improve design.
No Identification Needed	Full Production	This datasheet contains final specifications. Fairchild Semiconductor reserves the right to make changes at any time without notice to improve design.
Obsolete	Not In Production	This datasheet contains specifications on a product that has been discontinued by Fairchild semiconductor. The datasheet is printed for reference information only.