

International Rectifier

勝特力材料 886-3-5753170
 勝特力电子(上海) 86-21-34970699
 勝特力电子(深圳) 86-755-83298787
 Http://www.100y.com.tw

PD -95992

IRF7726PbF

HEXFET[®] Power MOSFET

- Ultra Low On-Resistance
- P-Channel MOSFET
- Very Small SOIC Package
- Low Profile (< 1.2mm)
- Available in Tape & Reel
- Lead-Free

V_{DS}	$R_{DS(on)}$ max	I_D
-30V	0.026@ $V_{GS} = -10V$	-7.0A
	0.040@ $V_{GS} = -4.5V$	-6.0A

Description

HEXFET[®] Power MOSFETs from International Rectifier utilize advanced processing techniques to achieve extremely low on-resistance per silicon area. This benefit, combined with the ruggedized device design, that International Rectifier is well known for, provides the designer with an extremely efficient and reliable device for battery and load management.

The new Micro8 package, with half the footprint area of the standard SO-8, provides the smallest footprint available in an SOIC outline. This makes the Micro8 an ideal device for applications where printed circuit board space is at a premium. The low profile (<1.2mm) of the Micro8 will allow it to fit easily into extremely thin application environments such as portable electronics and PCMCIA cards.

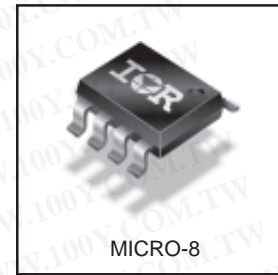
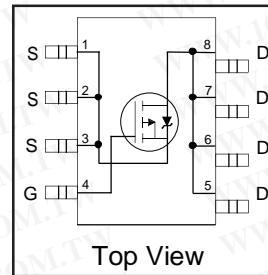

Absolute Maximum Ratings

	Parameter	Max.	Units
V_{DS}	Drain-Source Voltage	-30	V
I_D @ $T_A = 25^\circ C$	Continuous Drain Current, V_{GS} @ -10V	-7.0	A
I_D @ $T_A = 70^\circ C$	Continuous Drain Current, V_{GS} @ -10V	-5.7	
I_{DM}	Pulsed Drain Current ^①	-28	
P_D @ $T_A = 25^\circ C$	Maximum Power Dissipation ^③	1.79	W
P_D @ $T_A = 70^\circ C$	Maximum Power Dissipation ^③	1.14	W
	Linear Derating Factor	0.01	W/°C
V_{GS}	Gate-to-Source Voltage	±20	V
T_J, T_{STG}	Junction and Storage Temperature Range	-55 to +150	°C

Thermal Resistance

	Parameter	Max.	Units
$R_{\theta JA}$	Maximum Junction-to-Ambient ^③	70	°C/W

IRF7726PbF

International
IR Rectifier

Electrical Characteristics @ T_J = 25°C (unless otherwise specified)

	Parameter	Min.	Typ.	Max.	Units	Conditions
V _{(BR)DSS}	Drain-to-Source Breakdown Voltage	-30	—	—	V	V _{GS} = 0V, I _D = -250μA
ΔV _{(BR)DSS/ΔT_J}	Breakdown Voltage Temp. Coefficient	—	0.016	—	V/°C	Reference to 25°C, I _D = -1mA
R _{DS(on)}	Static Drain-to-Source On-Resistance	—	—	0.026	Ω	V _{GS} = -10V, I _D = -7.0A ②
		—	—	0.040		V _{GS} = -4.5V, I _D = -6.0A ②
V _{GS(th)}	Gate Threshold Voltage	-1.0	—	-2.5	V	V _{DS} = V _{GS} , I _D = -250μA
g _{fs}	Forward Transconductance	10	—	—	S	V _{DS} = -10V, I _D = -7.0A
I _{DSS}	Drain-to-Source Leakage Current	—	—	-15	μA	V _{DS} = -24V, V _{GS} = 0V
		—	—	-25		V _{DS} = -24V, V _{GS} = 0V, T _J = 70°C
I _{GSS}	Gate-to-Source Forward Leakage	—	—	-100	nA	V _{GS} = -20V
	Gate-to-Source Reverse Leakage	—	—	100		V _{GS} = 20V
Q _g	Total Gate Charge	—	46	69	nC	I _D = -7.0A
Q _{gs}	Gate-to-Source Charge	—	8.0	—		V _{DS} = -15V
Q _{gd}	Gate-to-Drain ("Miller") Charge	—	8.1	—		V _{GS} = -10V
t _{d(on)}	Turn-On Delay Time	—	15	23	ns	V _{DD} = -15V, V _{GS} = -10V
t _r	Rise Time	—	25	38		I _D = -1.0A
t _{d(off)}	Turn-Off Delay Time	—	227	341		R _G = 6.0Ω
t _f	Fall Time	—	107	161		R _D = 15Ω ②
C _{iss}	Input Capacitance	—	2204	—	pF	V _{GS} = 0V
C _{oss}	Output Capacitance	—	341	—		V _{DS} = -25V
C _{rss}	Reverse Transfer Capacitance	—	220	—		f = 1.0MHz

Source-Drain Ratings and Characteristics

	Parameter	Min.	Typ.	Max.	Units	Conditions
I _S	Continuous Source Current (Body Diode)	—	—	-1.8	A	MOSFET symbol showing the integral reverse p-n junction diode.
I _{SM}	Pulsed Source Current (Body Diode) ①	—	—	-28		
V _{SD}	Diode Forward Voltage	—	—	-1.2	V	T _J = 25°C, I _S = -1.8A, V _{GS} = 0V ②
t _{rr}	Reverse Recovery Time	—	35	53	ns	T _J = 25°C, I _F = -1.8A
Q _{rr}	Reverse Recovery Charge	—	32	48	μC	di/dt = -100A/μs ②

Notes:

- ① Repetitive rating; pulse width limited by max. junction temperature.
- ② Pulse width ≤ 400μs; duty cycle ≤ 2%.
- ③ When mounted on 1 inch square copper board, t < 10 sec.

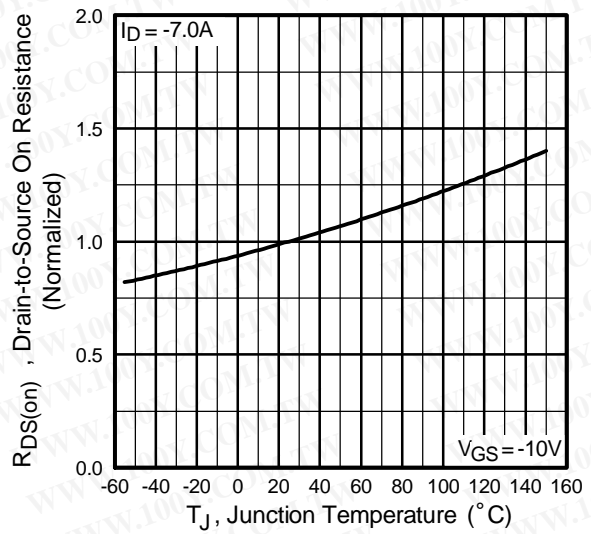
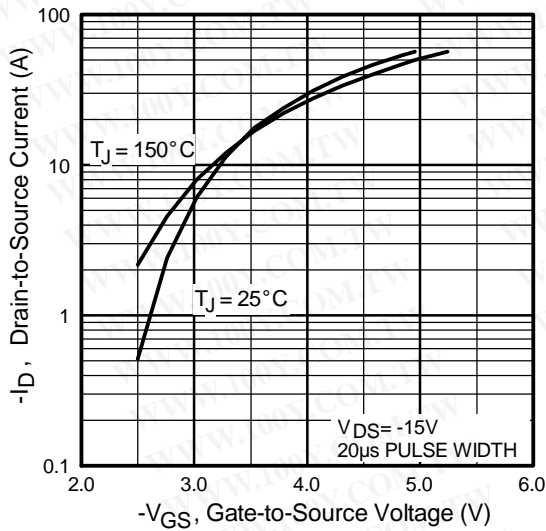
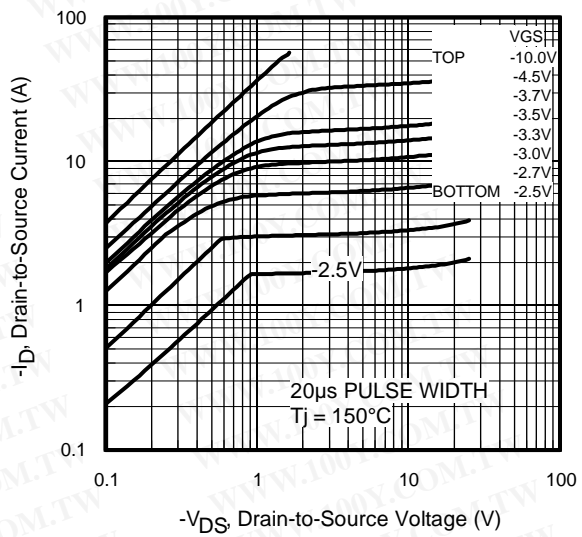
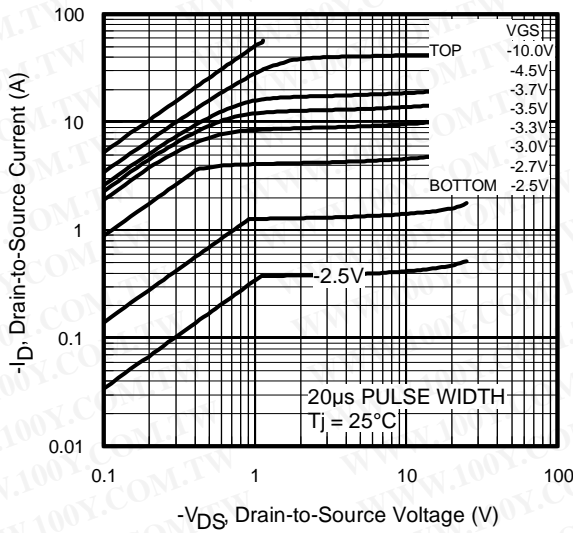

IRF7726PbF

International
IR Rectifier

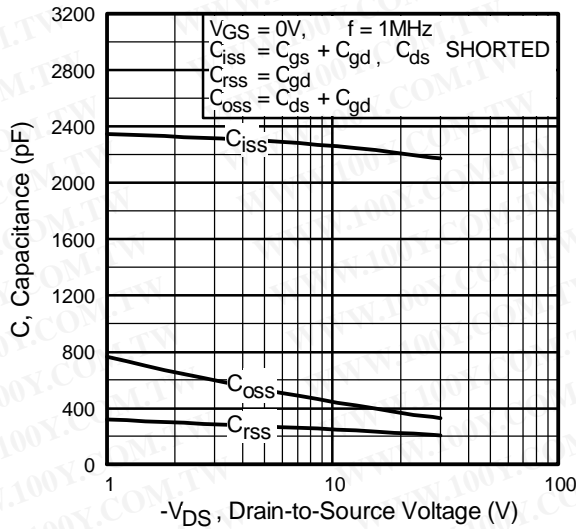

Fig 5. Typical Capacitance Vs. Drain-to-Source Voltage

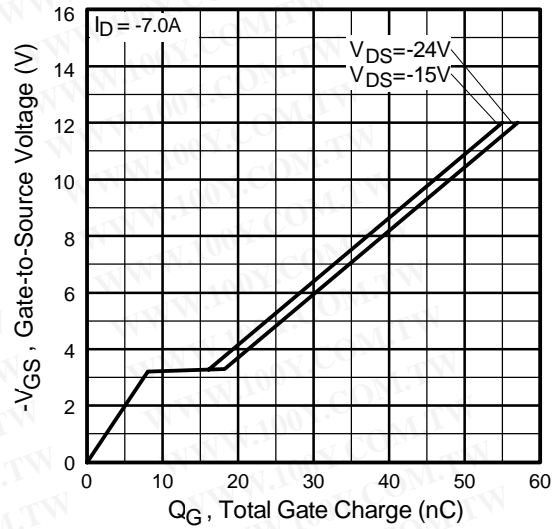

Fig 6. Typical Gate Charge Vs. Gate-to-Source Voltage

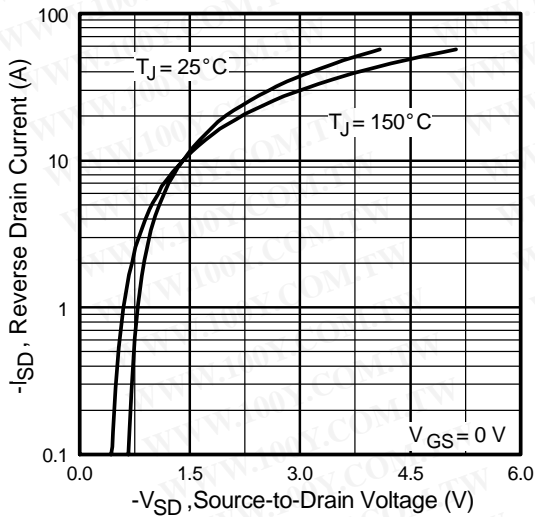

Fig 7. Typical Source-Drain Diode Forward Voltage

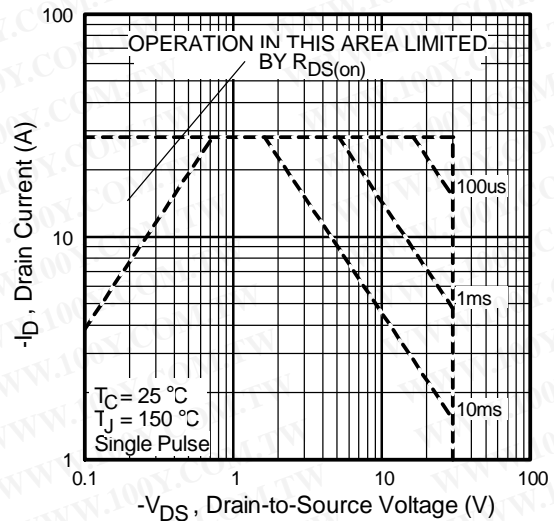

Fig 8. Maximum Safe Operating Area

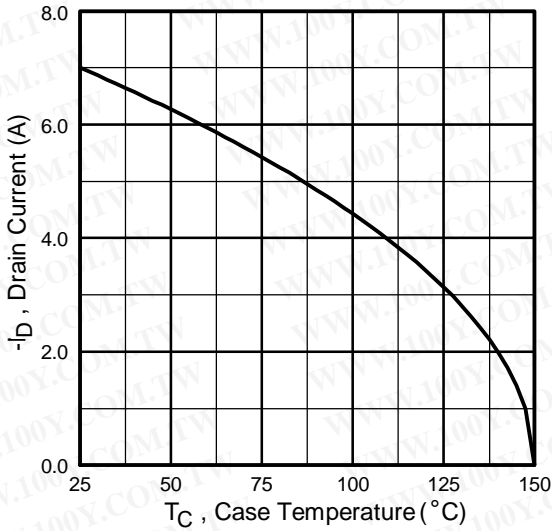

Fig 9. Maximum Drain Current Vs. Case Temperature

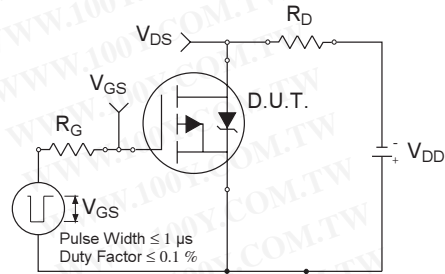

Fig 10a. Switching Time Test Circuit

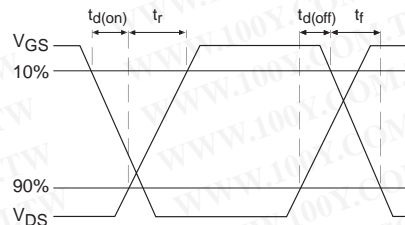

Fig 10b. Switching Time Waveforms

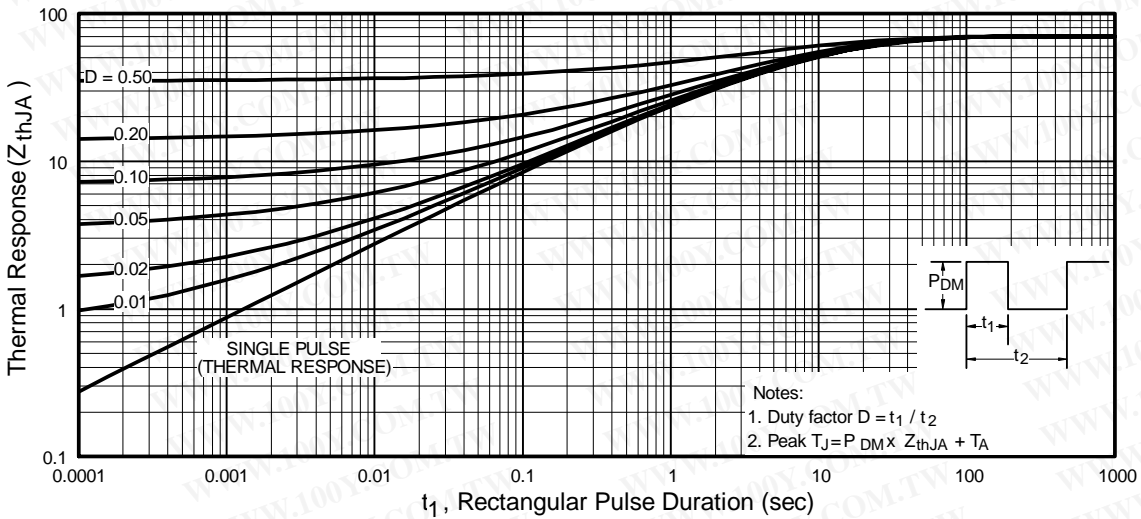

Fig 11. Maximum Effective Transient Thermal Impedance, Junction-to-Ambient

IRF7726PbF

International
IR Rectifier

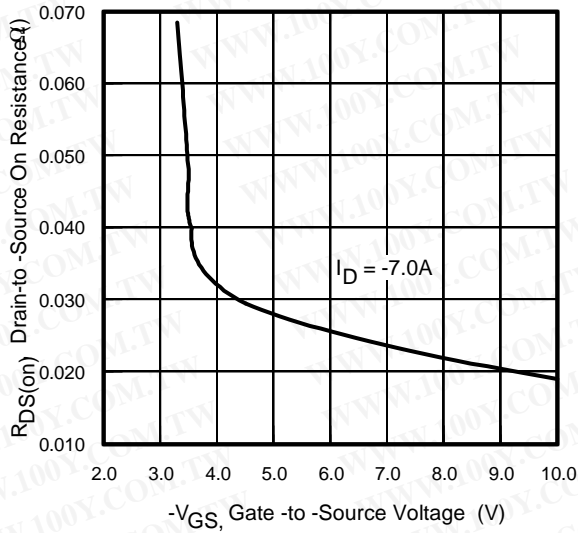

Fig 12. Typical On-Resistance Vs. Gate Voltage

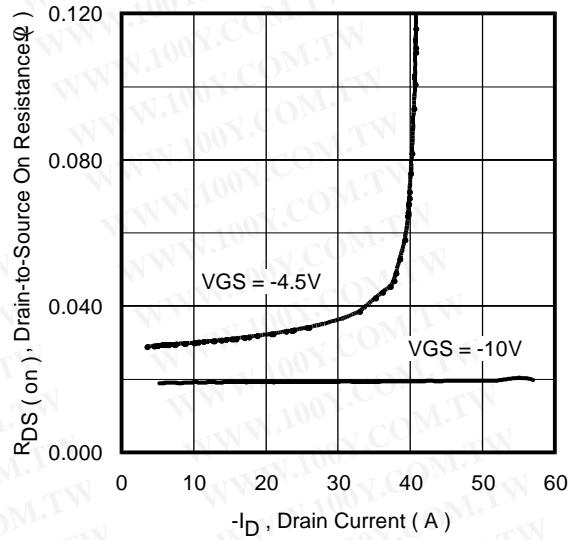

Fig 13. Typical On-Resistance Vs. Drain Current

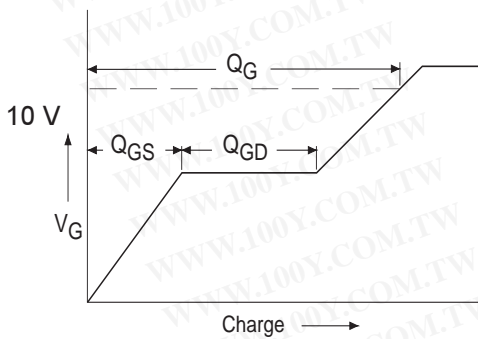

Fig 14a. Basic Gate Charge Waveform

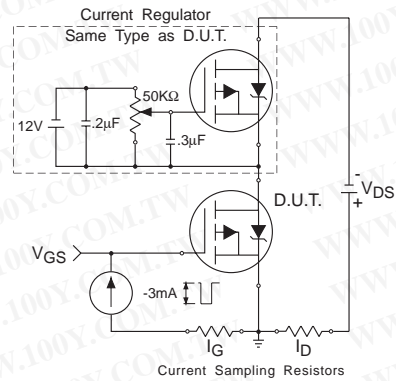

Fig 14b. Gate Charge Test Circuit

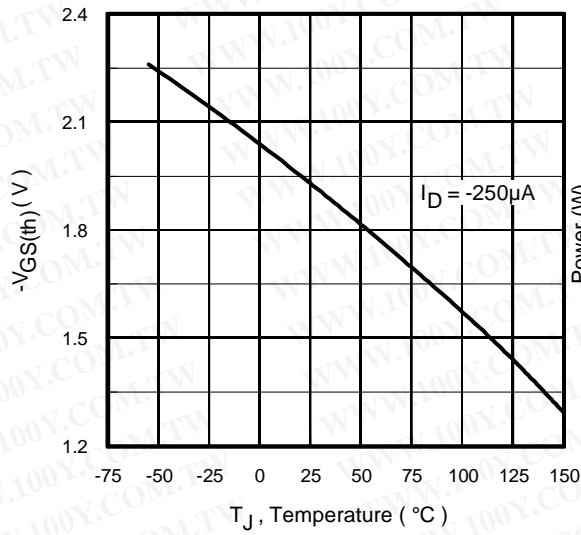

Fig 15. Typical $V_{GS(th)}$ Vs. Junction Temperature

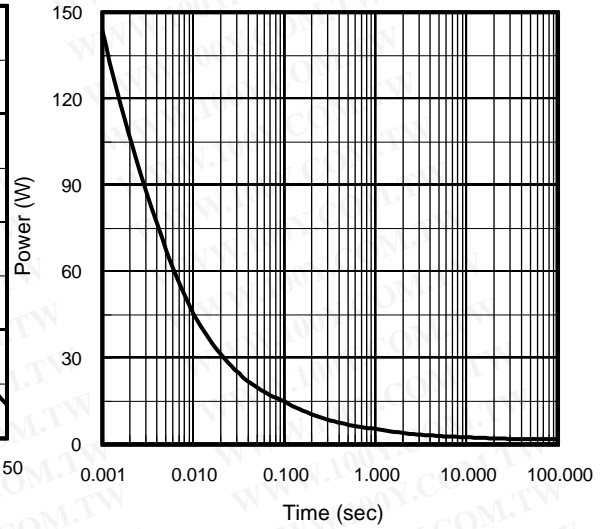
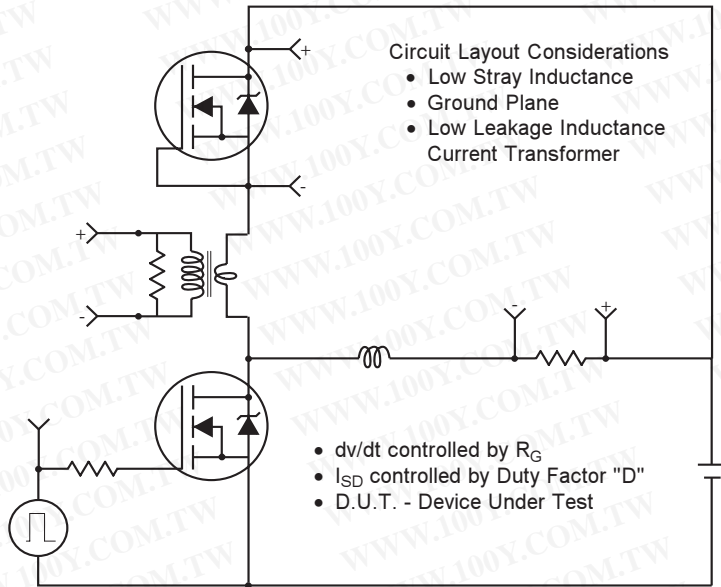

Fig 16. Typical Power Vs. Time

IRF7726PbF

International
IR Rectifier

Peak Diode Recovery dv/dt Test Circuit



* Reverse Polarity for P-Channel

** Use P-Channel Driver for P-Channel Measurements

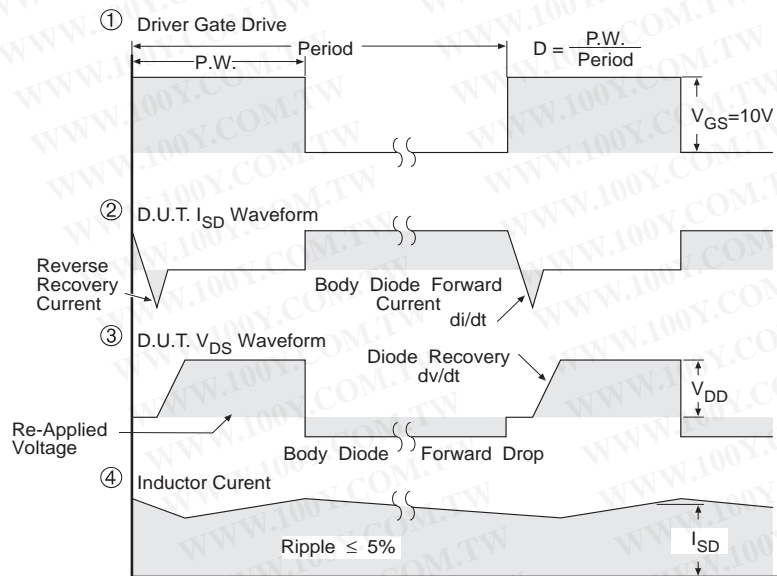

*** $V_{GS} = 5.0V$ for Logic Level and 3V Drive Devices

Fig 17 For P Channel HEXFETS

Micro8 Package Outline

Dimensions are shown in millimeters (inches)

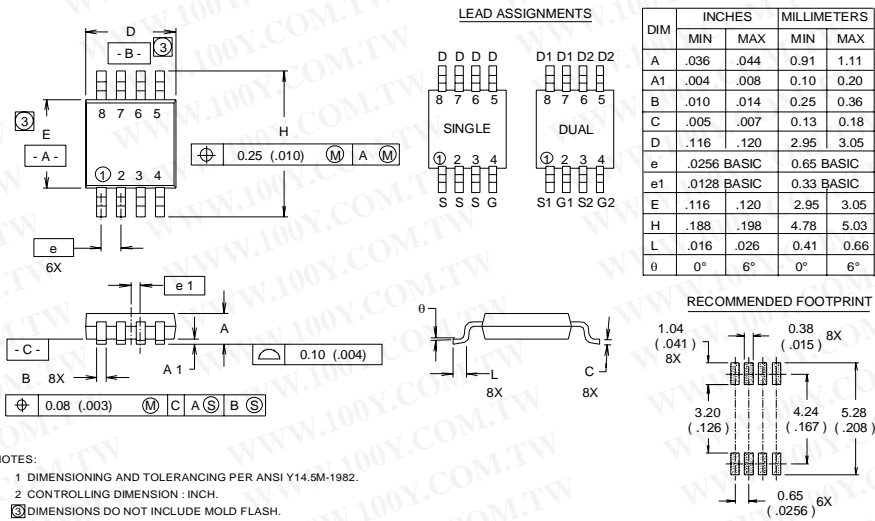

Micro8 Part Marking Information

EXAMPLE: THIS IS AN IRF7501

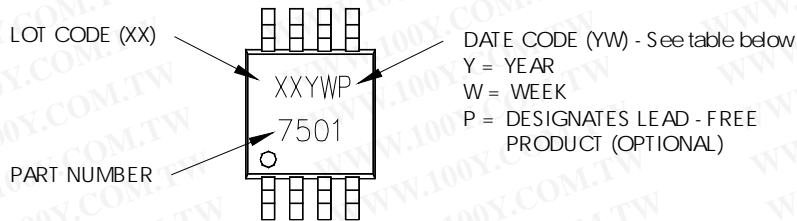

WW = (1-26) IF PRECEDED BY LAST DIGIT OF CALENDAR YEAR

WW = (27-52) IF PRECEDED BY A LETTER

YEAR	Y	WORK WEEK	W
2001	1	01	A
2002	2	02	B
2003	3	03	C
2004	4	04	D
2005	5		
2006	6		
2007	7		
2008	8		
2009	9		
2010	0	24	X
		25	Y
		26	Z

YEAR	Y	WORK WEEK	W
2001	A	27	A
2002	B	28	B
2003	C	29	C
2004	D	30	D
2005	E		
2006	F		
2007	G		
2008	H		
2009	J		
2010	K	50	X
		51	Y
		52	Z

IRF7726PbF

勝特力材料 886-3-5753170
勝特力电子(上海) 86-21-34970699
勝特力电子(深圳) 86-755-83298787
[Http://www.100y.com.tw](http://www.100y.com.tw)

International
IR Rectifier

Micro8 Tape & Reel Information

Dimensions are shown in millimeters (inches)

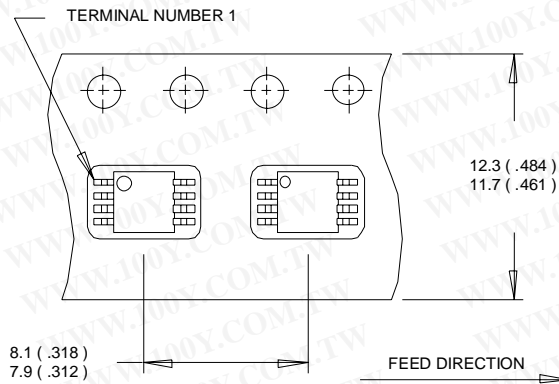

NOTES:

1. OUTLINE CONFORMS TO EIA-481 & EIA-541.
2. CONTROLLING DIMENSION : MILLIMETER.

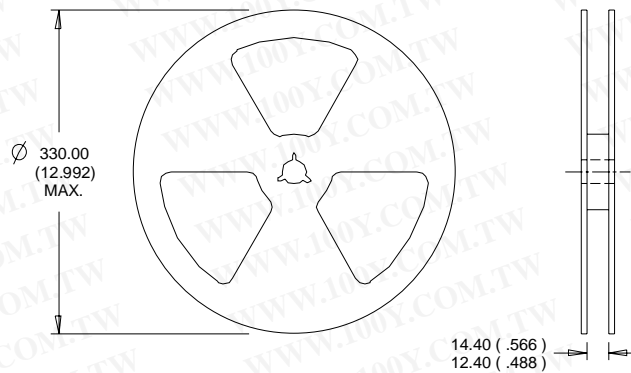

NOTES:

1. CONTROLLING DIMENSION : MILLIMETER.
2. OUTLINE CONFORMS TO EIA-481 & EIA-541.

Data and specifications subject to change without notice.
This product has been designed and qualified for the Consumer market.
Qualifications Standards can be found on IR's Web site.

International
IR Rectifier

IR WORLD HEADQUARTERS: 233 Kansas St., El Segundo, California 90245, USA Tel: (310) 252-7105
TAC Fax: (310) 252-7903

Visit us at www.irf.com for sales contact information.02/05

www.irf.com