

IRFBA90N20DPbF

HEXFET® Power MOSFET

Applications

- High frequency DC-DC converters
- Lead-Free

| | | |
|------------------------|-------------------------------|------------------------|
| V_{DSS} | R_{DS(on)} max | I_D |
| 200V | 0.023Ω | 98A[Ⓒ] |

Benefits

- Low Gate-to-Drain Charge to Reduce Switching Losses
- Fully Characterized Capacitance Including Effective C_{OSS} to Simplify Design, (See App. Note AN1001)
- Fully Characterized Avalanche Voltage and Current

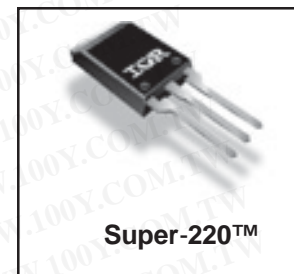

Absolute Maximum Ratings

| | Parameter | Max. | Units |
|---|--|-----------------|-------|
| I _D @ T _C = 25°C | Continuous Drain Current, V _{GS} @ 10V | 98 [Ⓒ] | A |
| I _D @ T _C = 100°C | Continuous Drain Current, V _{GS} @ 10V | 71 [Ⓒ] | |
| I _{DM} | Pulsed Drain Current [Ⓓ] | 390 | |
| P _D @ T _C = 25°C | Power Dissipation | 650 | W |
| | Linear Derating Factor | 4.3 | W/°C |
| V _{GS} | Gate-to-Source Voltage | ± 30 | V |
| dv/dt | Peak Diode Recovery dv/dt [Ⓔ] | 6.3 | V/ns |
| T _J | Operating Junction and Storage Temperature Range | -55 to + 175 | °C |
| T _{STG} | | | |
| | | | |
| | Recommended Clip Force | 20 | N |

Thermal Resistance

| | Parameter | Typ. | Max. | Units |
|------------------|-------------------------------------|------|------|-------|
| R _{θJC} | Junction-to-Case | — | 0.23 | °C/W |
| R _{θCS} | Case-to-Sink, Flat, Greased Surface | 0.50 | — | |
| R _{θJA} | Junction-to-Ambient | — | 58 | |

Notes [Ⓓ] through [Ⓔ] are on page 8

www.irf.com

IRFBA90N20DPbF

International
IR Rectifier

Static @ T_J = 25°C (unless otherwise specified)

| | Parameter | Min. | Typ. | Max. | Units | Conditions |
|--------------------------------------|--------------------------------------|------|------|-------|-------|--|
| V _{(BR)DSS} | Drain-to-Source Breakdown Voltage | 200 | — | — | V | V _{GS} = 0V, I _D = 250μA |
| ΔV _{(BR)DSS/ΔT_J} | Breakdown Voltage Temp. Coefficient | — | 0.22 | — | V/°C | Reference to 25°C, I _D = 1mA |
| R _{DS(on)} | Static Drain-to-Source On-Resistance | — | — | 0.023 | Ω | V _{GS} = 10V, I _D = 59A ④ |
| V _{GS(th)} | Gate Threshold Voltage | 3.0 | — | 5.0 | V | V _{DS} = V _{GS} , I _D = 250μA |
| I _{DSS} | Drain-to-Source Leakage Current | — | — | 25 | μA | V _{DS} = 200V, V _{GS} = 0V |
| | | — | — | 250 | | V _{DS} = 160V, V _{GS} = 0V, T _J = 150°C |
| I _{GSS} | Gate-to-Source Forward Leakage | — | — | 100 | nA | V _{GS} = 30V |
| | Gate-to-Source Reverse Leakage | — | — | -100 | | V _{GS} = -30V |

Dynamic @ T_J = 25°C (unless otherwise specified)

| | Parameter | Min. | Typ. | Max. | Units | Conditions |
|-----------------------|---------------------------------|------|------|------|-------|--|
| g _{fs} | Forward Transconductance | 41 | — | — | S | V _{DS} = 50V, I _D = 59A |
| Q _g | Total Gate Charge | — | 160 | 240 | nC | I _D = 59A |
| Q _{gs} | Gate-to-Source Charge | — | 45 | 67 | | V _{DS} = 160V |
| Q _{gd} | Gate-to-Drain ("Miller") Charge | — | 75 | 110 | | V _{GS} = 10V ④ |
| t _{d(on)} | Turn-On Delay Time | — | 23 | — | ns | V _{DD} = 100V |
| t _r | Rise Time | — | 160 | — | | I _D = 59A |
| t _{d(off)} | Turn-Off Delay Time | — | 39 | — | | R _G = 1.2Ω |
| t _f | Fall Time | — | 77 | — | | V _{GS} = 10V ④ |
| C _{iss} | Input Capacitance | — | 6080 | — | pF | V _{GS} = 0V |
| C _{oss} | Output Capacitance | — | 1040 | — | | V _{DS} = 25V |
| C _{rss} | Reverse Transfer Capacitance | — | 150 | — | | f = 1.0MHz |
| C _{oss} | Output Capacitance | — | 7500 | — | | V _{GS} = 0V, V _{DS} = 1.0V, f = 1.0MHz |
| C _{oss} | Output Capacitance | — | 410 | — | | V _{GS} = 0V, V _{DS} = 160V, f = 1.0MHz |
| C _{oss eff.} | Effective Output Capacitance | — | 790 | — | | V _{GS} = 0V, V _{DS} = 0V to 160V ⑤ |
| | | — | — | — | | |

Avalanche Characteristics

| | Parameter | Typ. | Max. | Units |
|-----------------|--------------------------------|------|------|-------|
| E _{AS} | Single Pulse Avalanche Energy② | — | 960 | mJ |
| I _{AR} | Avalanche Current① | — | 59 | A |
| E _{AR} | Repetitive Avalanche Energy① | — | 65 | mJ |

Diode Characteristics

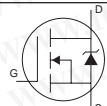
| | Parameter | Min. | Typ. | Max. | Units | Conditions |
|-----------------|--|--|------|------|-------|--|
| I _S | Continuous Source Current (Body Diode) | — | — | 98 | A | MOSFET symbol showing the integral reverse p-n junction diode.  |
| I _{SM} | Pulsed Source Current (Body Diode) ① | — | — | 390 | | |
| V _{SD} | Diode Forward Voltage | — | — | 1.5 | V | T _J = 25°C, I _S = 59A, V _{GS} = 0V ④ |
| t _{rr} | Reverse Recovery Time | — | 220 | 340 | nS | T _J = 25°C, I _F = 59A |
| Q _{rr} | Reverse Recovery Charge | — | 1.9 | 2.8 | μC | di/dt = 100A/μs ④ |
| t _{on} | Forward Turn-On Time | Intrinsic turn-on time is negligible (turn-on is dominated by L _S +L _D) | | | | |

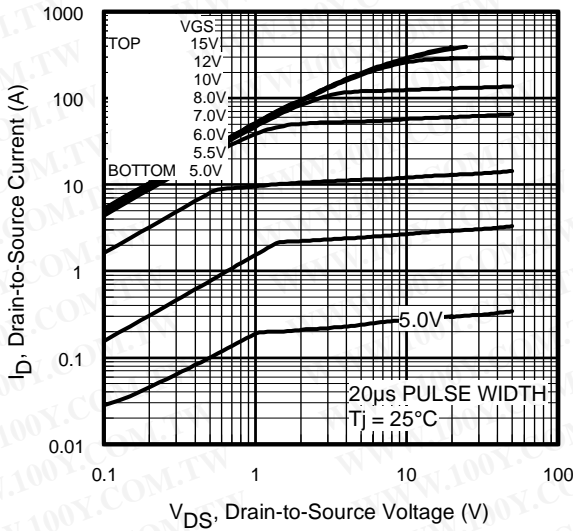

Fig 1. Typical Output Characteristics

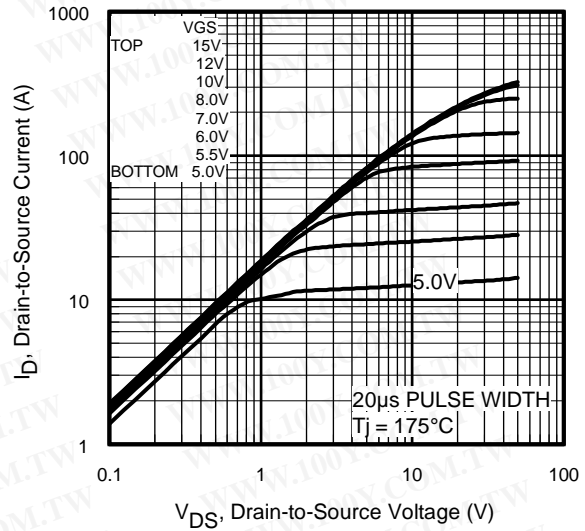

Fig 2. Typical Output Characteristics

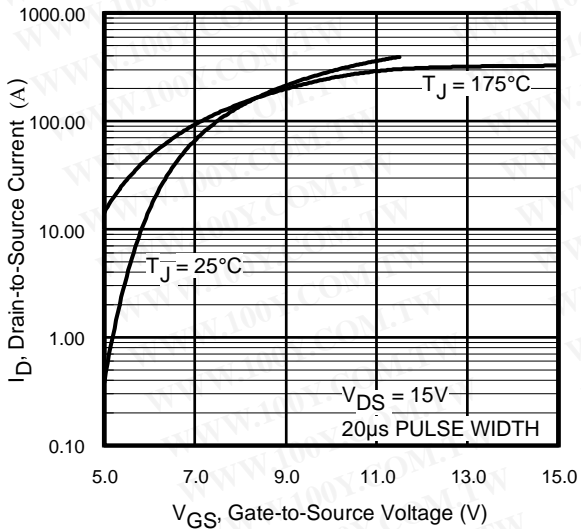

Fig 3. Typical Transfer Characteristics

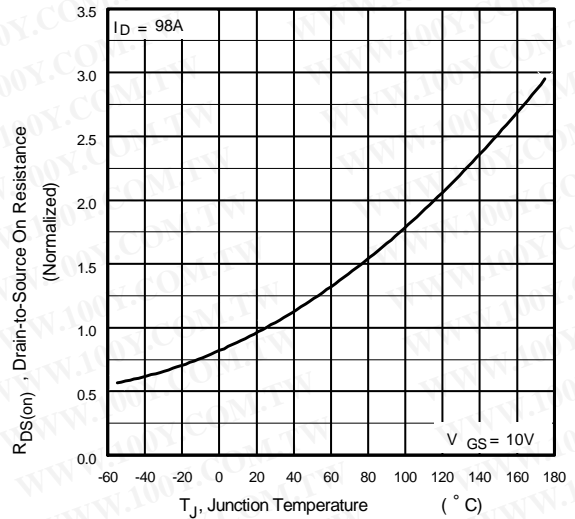

Fig 4. Normalized On-Resistance Vs. Temperature

IRFBA90N20DPbF

International
IR Rectifier

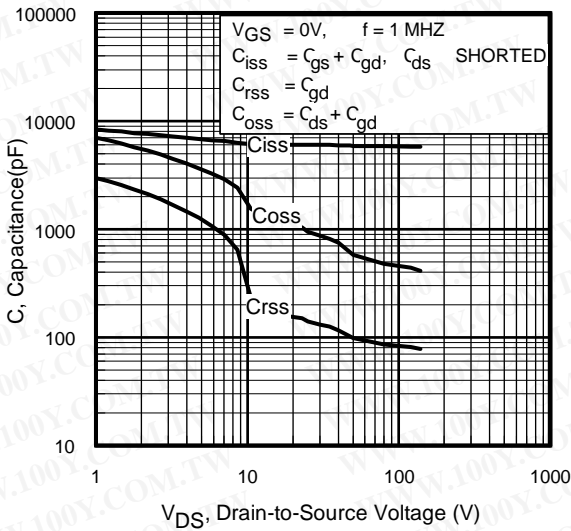

Fig 5. Typical Capacitance Vs. Drain-to-Source Voltage

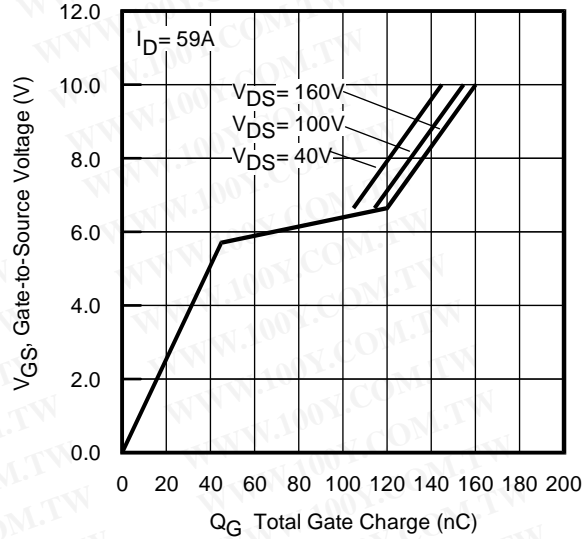

Fig 6. Typical Gate Charge Vs. Gate-to-Source Voltage

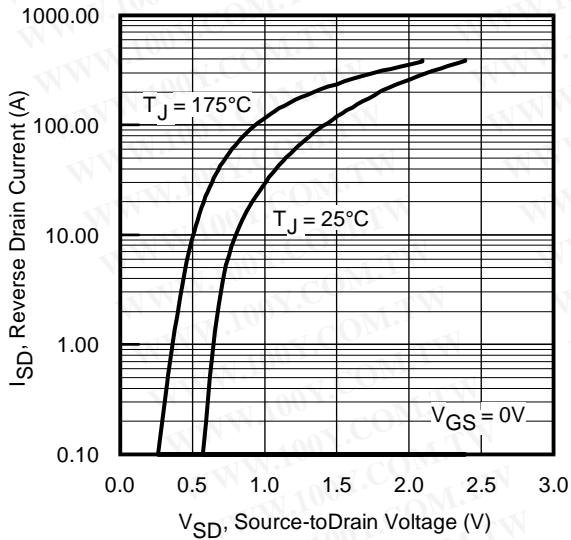

Fig 7. Typical Source-Drain Diode Forward Voltage

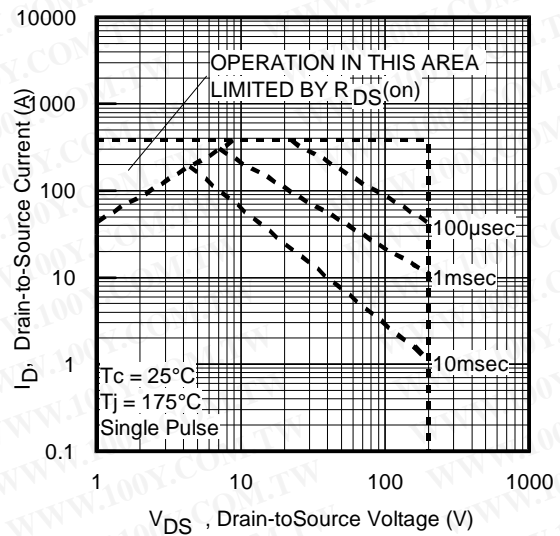

Fig 8. Maximum Safe Operating Area

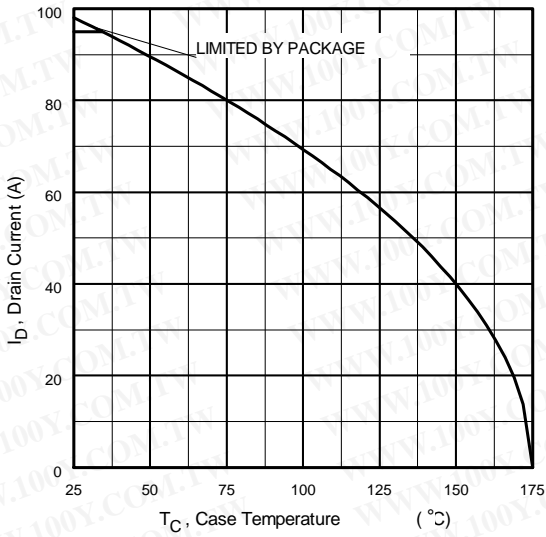

Fig 9. Maximum Drain Current Vs. Case Temperature

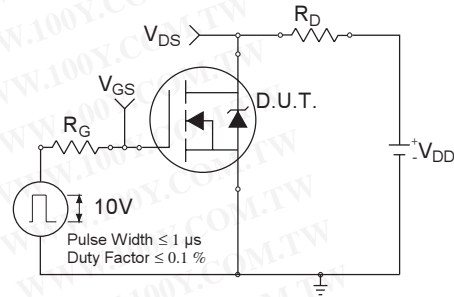

Fig 10a. Switching Time Test Circuit

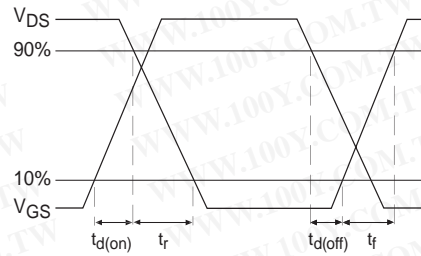

Fig 10b. Switching Time Waveforms

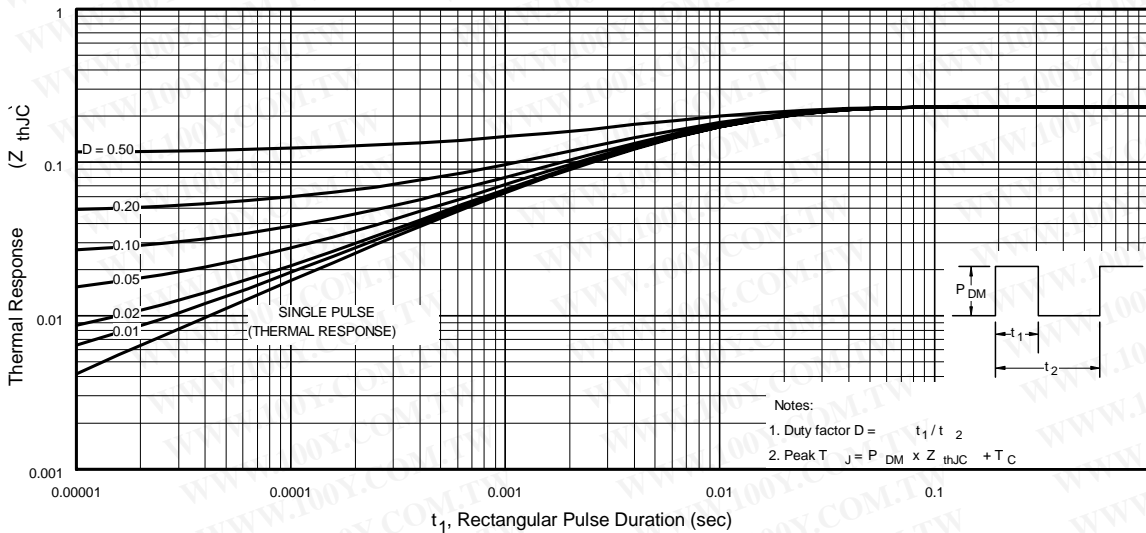

Fig 11. Maximum Effective Transient Thermal Impedance, Junction-to-Case

IRFBA90N20DPbF

International
IR Rectifier

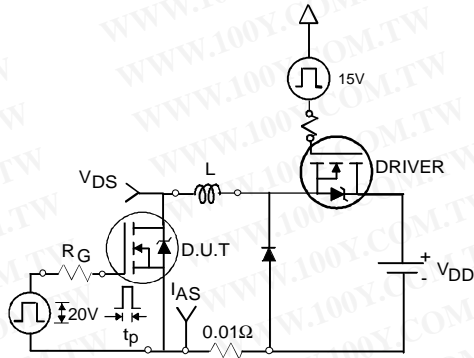

Fig 12a. Unclamped Inductive Test Circuit

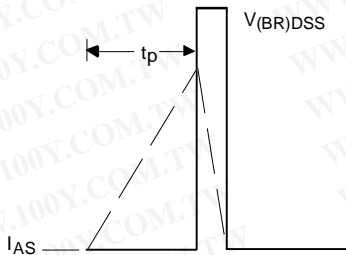

Fig 12b. Unclamped Inductive Waveforms

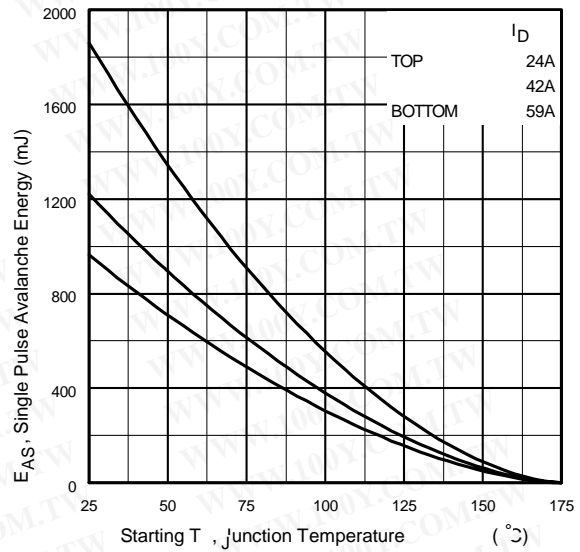

Fig 12c. Maximum Avalanche Energy Vs. Drain Current

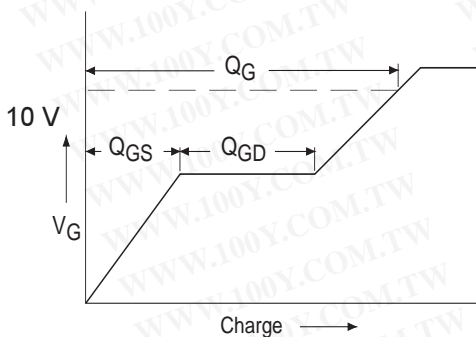

Fig 13a. Basic Gate Charge Waveform

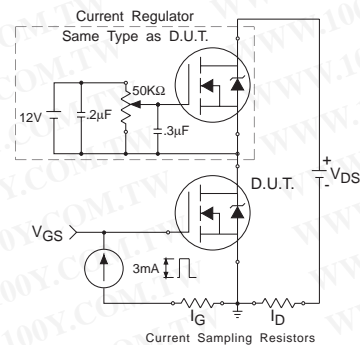
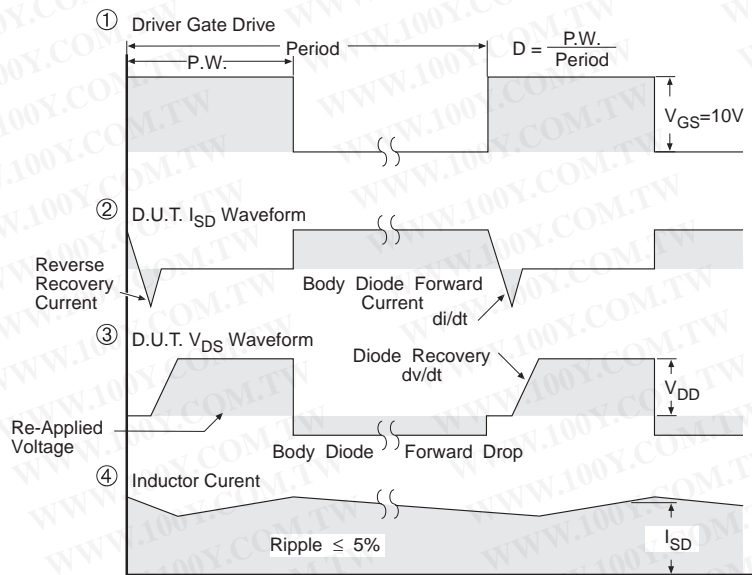
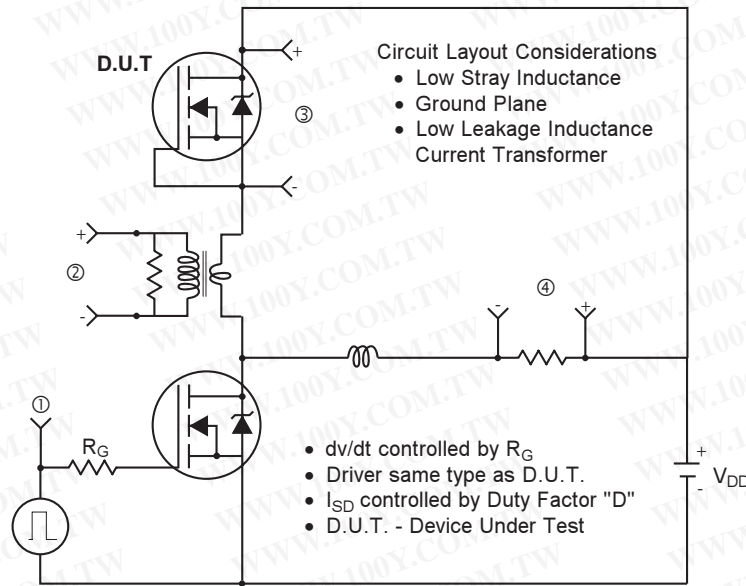

Fig 13b. Gate Charge Test Circuit

Peak Diode Recovery dv/dt Test Circuit



* $V_{GS} = 5V$ for Logic Level Devices

Fig 14. For N-Channel HEXFET® Power MOSFETs

IRFBA90N20DPbF

International
IR Rectifier

Super-220™ (TO-273AA) Package Outline

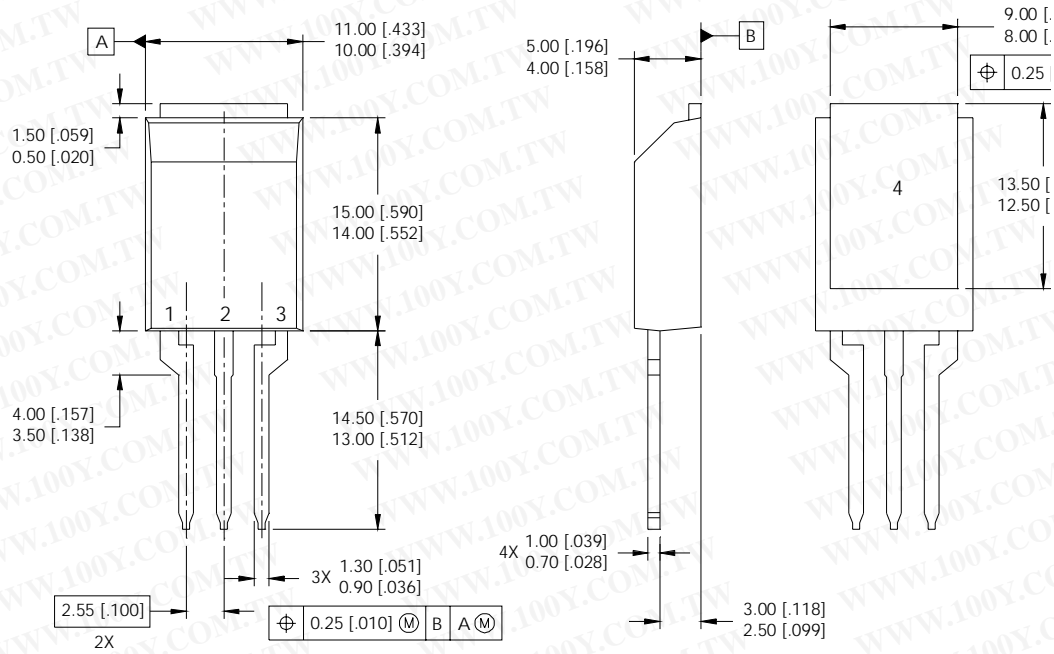

NOTES:

1. DIMENSIONING & TOLERANCING PER ASME Y14.5M-1994.
2. CONTROLLING DIMENSION: MILLIMETER.
3. DIMENSIONS ARE SHOWN IN MILLIMETERS [INCHES].
4. OUTLINE CONFORMS TO JEDEC OUTLINE TO-273AA.

LEAD ASSIGNMENTS

MOSFET

- 1 - GATE
- 2 - DRAIN
- 3 - SOURCE
- 4 - DRAIN

IGBT

- 1 - GATE
- 2 - COLLECTOR
- 3 - EMITTER
- 4 - COLLECTOR

Notes:

- ① Repetitive rating; pulse width limited by max. junction temperature.
- ② Starting $T_J = 25^\circ\text{C}$, $L = 0.55\text{mH}$
 $R_G = 25\Omega$, $I_{AS} = 59\text{A}$.
- ③ $I_{SD} \leq 59\text{A}$, $di/dt \leq 170\text{A}/\mu\text{s}$, $V_{DD} \leq V_{(BR)DSS}$,
 $T_J \leq 175^\circ\text{C}$

- ④ Pulse width $\leq 300\mu\text{s}$; duty cycle $\leq 2\%$.
- ⑤ $C_{oss\ eff.}$ is a fixed capacitance that gives the same charging time as C_{oss} while V_{DS} is rising from 0 to 80% V_{DSS}
- ⑥ Calculated continuous current based on maximum allowable junction temperature. Package limitation current is 95A.

勝特力材料 886-3-5753170
勝特力电子(上海) 86-21-34970699
勝特力电子(深圳) 86-755-83298787
Http://www.100y.com.tw

International
IR Rectifier

IRFBA90N20DPbF

Super-220 (TO-273AA) Part Marking Information

EXAMPLE: THIS IS AN IRFBA22N50A WITH
ASSEMBLY LOT CODE 1789
ASSEMBLED ON WW 19, 1997
IN THE ASSEMBLY LINE "C"

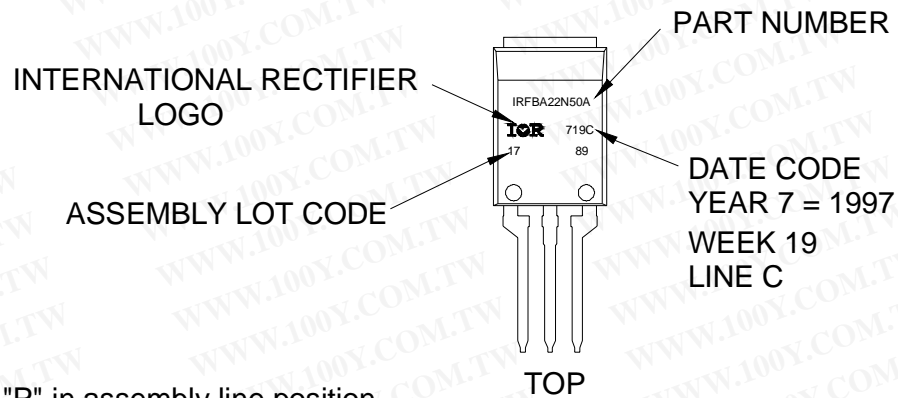

Note: "P" in assembly line position
indicates "Lead-Free"

Super-220™ not recommended for surface mount application.

Data and specifications subject to change without notice.
This product has been designed and qualified for the Industrial market.
Qualification Standards can be found on IR's Web site.

International
IR Rectifier

IR WORLD HEADQUARTERS: 233 Kansas St., El Segundo, California 90245, USA Tel: (310) 252-7105
TAC Fax: (310) 252-7903

Visit us at www.irf.com for sales contact information.09/04