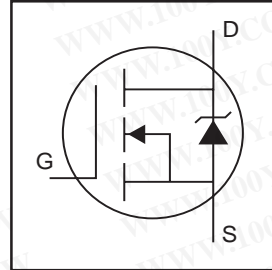


# International **IR** Rectifier

# IRFIZ24EPbF

HEXFET® Power MOSFET

- Advanced Process Technology
- Isolated Package
- High Voltage Isolation = 2.5KV RMS ⑤
- Sink to Lead Creepage Dist. = 4.8mm
- Fully Avalanche Rated
- Lead-Free

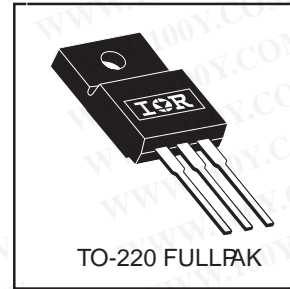


$V_{DSS} = 60V$
$R_{DS(on)} = 0.071\Omega$
$I_D = 14A$

## Description

Fifth Generation HEXFETs from International Rectifier utilize advanced processing techniques to achieve extremely low on-resistance per silicon area. This benefit, combined with the fast switching speed and ruggedized device design that HEXFET Power MOSFETs are well known for, provides the designer with an extremely efficient and reliable device for use in a wide variety of applications.

The TO-220 Fullpak eliminates the need for additional insulating hardware in commercial-industrial applications. The moulding compound used provides a high isolation capability and a low thermal resistance between the tab and external heatsink. This isolation is equivalent to using a 100 micron mica barrier with standard TO-220 product. The Fullpak is mounted to a heatsink using a single clip or by a single screw fixing.



## Absolute Maximum Ratings

	Parameter	Max.	Units
$I_D @ T_C = 25^\circ C$	Continuous Drain Current, $V_{GS} @ 10V$	14	A
$I_D @ T_C = 100^\circ C$	Continuous Drain Current, $V_{GS} @ 10V$	9.6	
$I_{DM}$	Pulsed Drain Current ①⑥	68	
$P_D @ T_C = 25^\circ C$	Power Dissipation	29	W
	Linear Derating Factor	0.19	W/°C
$V_{GS}$	Gate-to-Source Voltage	$\pm 20$	V
$E_{AS}$	Single Pulse Avalanche Energy②⑥	71	mJ
$I_{AR}$	Avalanche Current①⑥	10	A
$E_{AR}$	Repetitive Avalanche Energy①	2.9	mJ
dv/dt	Peak Diode Recovery dv/dt ③④	5.0	V/ns
$T_J$	Operating Junction and Storage Temperature Range	-55 to +175	°C
$T_{STG}$			
	Mounting torque, 6-32 or M3 screw	10 lbf·in (1.1N·m)	

## Thermal Resistance

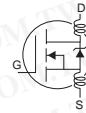
	Parameter	Typ.	Max.	Units
$R_{\theta JC}$	Junction-to-Case	---	5.2	°C/W
$R_{\theta JA}$	Junction-to-Ambient	---	65	

# IRFIZ24EPbF

International  
IR Rectifier

## Electrical Characteristics @ $T_J = 25^\circ\text{C}$ (unless otherwise specified)

	Parameter	Min.	Typ.	Max.	Units	Conditions
$V_{(BR)DSS}$	Drain-to-Source Breakdown Voltage	60	—	—	V	$V_{GS} = 0V, I_D = 250\mu A$
$\Delta V_{(BR)DSS}/\Delta T_J$	Breakdown Voltage Temp. Coefficient	—	0.052	—	V/°C	Reference to $25^\circ\text{C}, I_D = 1\text{mA}$ ⑥
$R_{DS(on)}$	Static Drain-to-Source On-Resistance	—	—	0.071	$\Omega$	$V_{GS} = 10V, I_D = 7.8A$ ④
$V_{GS(th)}$	Gate Threshold Voltage	2.0	—	4.0	V	$V_{DS} = V_{GS}, I_D = 250\mu A$
$g_{fs}$	Forward Transconductance	4.5	—	—	S	$V_{DS} = 25V, I_D = 10A$ ⑥
$I_{DSS}$	Drain-to-Source Leakage Current	—	—	25	$\mu A$	$V_{DS} = 60V, V_{GS} = 0V$
		—	—	250		$V_{DS} = 48V, V_{GS} = 0V, T_J = 150^\circ\text{C}$
$I_{GSS}$	Gate-to-Source Forward Leakage	—	—	100	nA	$V_{GS} = 20V$
	Gate-to-Source Reverse Leakage	—	—	-100		$V_{GS} = -20V$
$Q_g$	Total Gate Charge	—	—	20	nC	$I_D = 10A$
$Q_{gs}$	Gate-to-Source Charge	—	—	5.3		$V_{DS} = 44V$
$Q_{gd}$	Gate-to-Drain ("Miller") Charge	—	—	7.6		$V_{GS} = 10V$ , See Fig. 6 and 13 ④ ⑥
$t_{d(on)}$	Turn-On Delay Time	—	4.9	—	ns	$V_{DD} = 28V$
$t_r$	Rise Time	—	34	—		$I_D = 10A$
$t_{d(off)}$	Turn-Off Delay Time	—	19	—		$R_G = 24\Omega$
$t_f$	Fall Time	—	27	—		$R_D = 2.6\Omega$ , See Fig. 10 ④ ⑥
$L_D$	Internal Drain Inductance	—	4.5	—	nH	Between lead, 6mm (0.25in.) from package and center of die contact
$L_S$	Internal Source Inductance	—	7.5	—		
$C_{iss}$	Input Capacitance	—	370	—	pF	$V_{GS} = 0V$
$C_{oss}$	Output Capacitance	—	140	—		$V_{DS} = 25V$
$C_{rss}$	Reverse Transfer Capacitance	—	65	—		$f = 1.0\text{MHz}$ , See Fig. 5 ⑥
C	Drain to Sink Capacitance	—	12	—		$f = 1.0\text{MHz}$

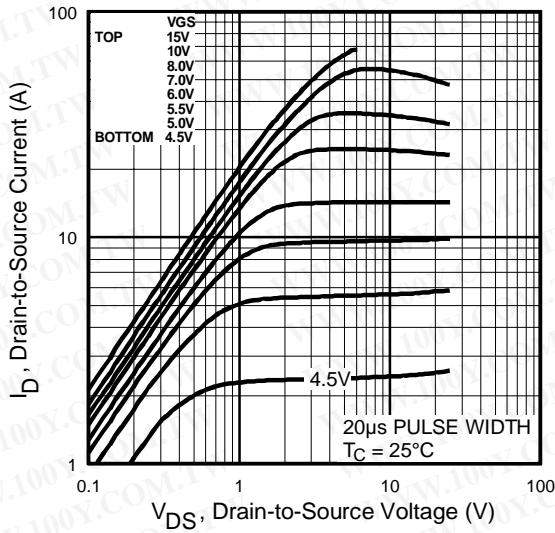


## Source-Drain Ratings and Characteristics

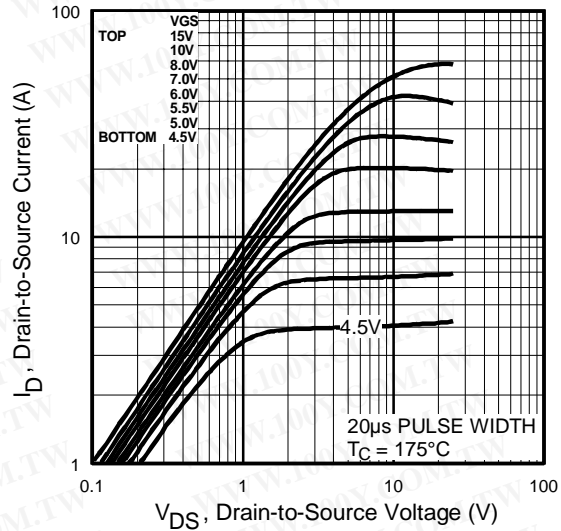
	Parameter	Min.	Typ.	Max.	Units	Conditions
$I_S$	Continuous Source Current (Body Diode)	—	—	14	A	MOSFET symbol showing the integral reverse p-n junction diode.
$I_{SM}$	Pulsed Source Current (Body Diode) ① ⑥	—	—	68		
$V_{SD}$	Diode Forward Voltage	—	—	1.3	V	$T_J = 25^\circ\text{C}, I_S = 7.8A, V_{GS} = 0V$ ④
$t_{rr}$	Reverse Recovery Time	—	56	83	ns	$T_J = 25^\circ\text{C}, I_F = 10A$
$Q_{rr}$	Reverse Recovery Charge	—	120	180	$\mu C$	$di/dt = 100A/\mu s$ ④ ⑥
$t_{on}$	Forward Turn-On Time	Intrinsic turn-on time is negligible (turn-on is dominated by $L_S + L_D$ )				

### Notes:

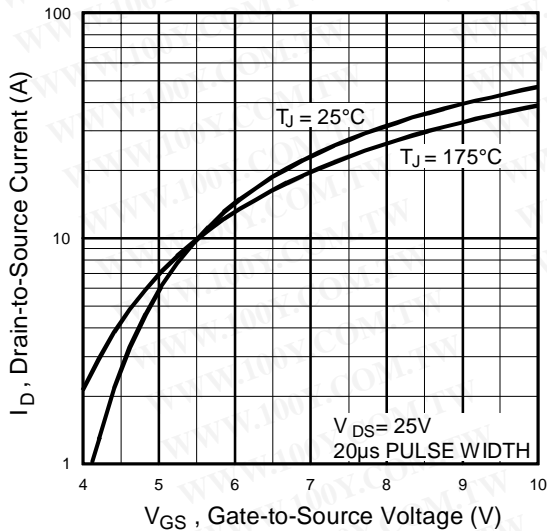
- ① Repetitive rating; pulse width limited by max. junction temperature. ( See fig. 11 )
- ②  $V_{DD} = 25V$ , starting  $T_J = 25^\circ\text{C}$ ,  $L = 1.0\text{mH}$   
 $R_G = 25\Omega, I_{AS} = 10A$ . (See Figure 12)
- ③  $I_{SD} \leq 10A, di/dt \leq 280A/\mu s, V_{DD} \leq V_{(BR)DSS}, T_J \leq 175^\circ\text{C}$
- ④ Pulse width  $\leq 300\mu s$ ; duty cycle  $\leq 2\%$ .
- ⑤  $t = 60s, f = 60\text{Hz}$
- ⑥ Uses IRFZ24N data and test conditions



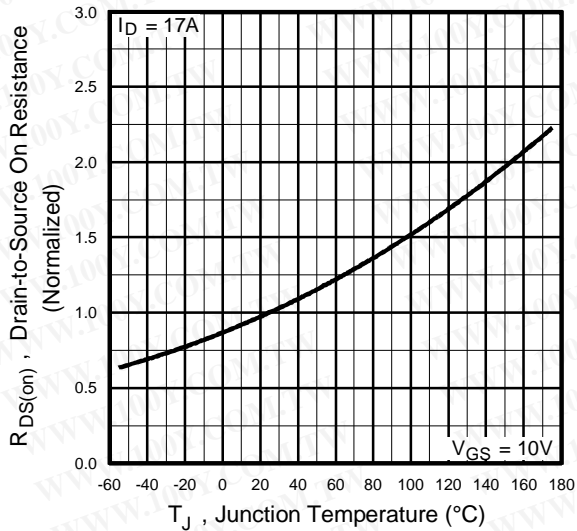
**Fig 1.** Typical Output Characteristics



**Fig 2.** Typical Output Characteristics



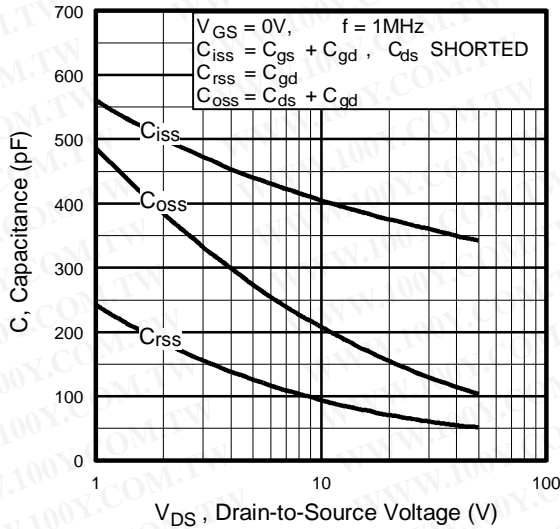
**Fig 3.** Typical Transfer Characteristics



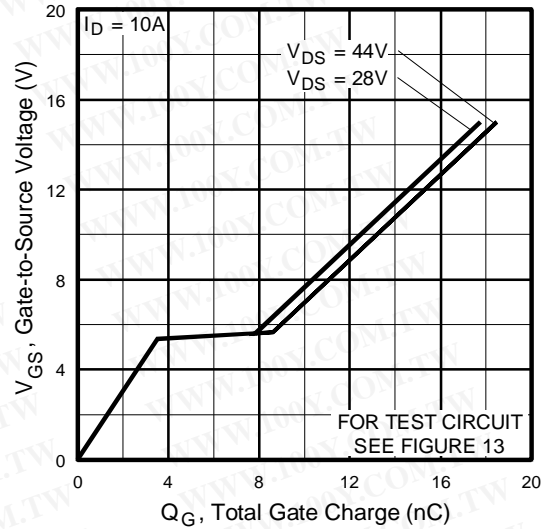
**Fig 4.** Normalized On-Resistance Vs. Temperature

# IRFIZ24EPbF

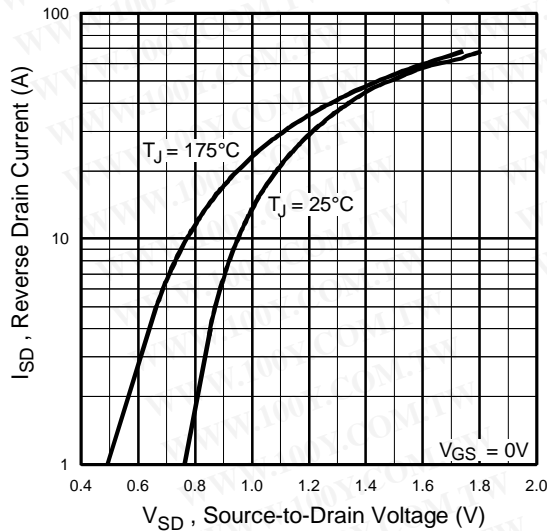
International  
**IR** Rectifier



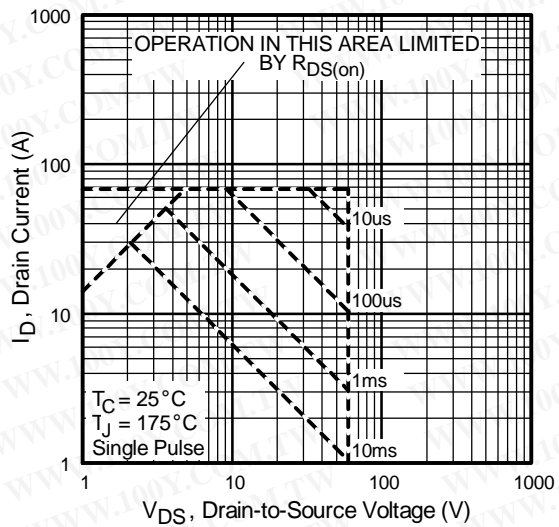
**Fig 5.** Typical Capacitance Vs. Drain-to-Source Voltage



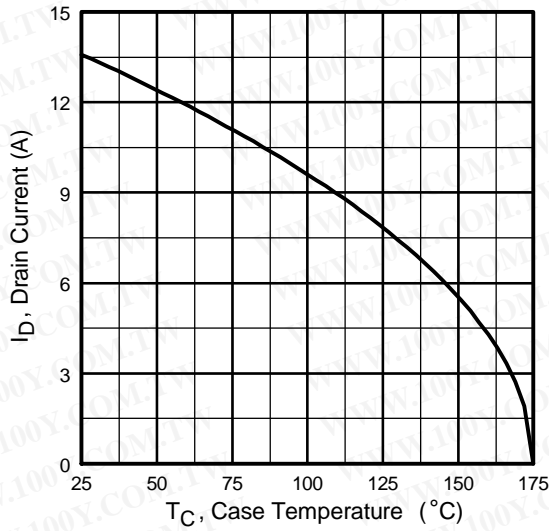
**Fig 6.** Typical Gate Charge Vs. Gate-to-Source Voltage



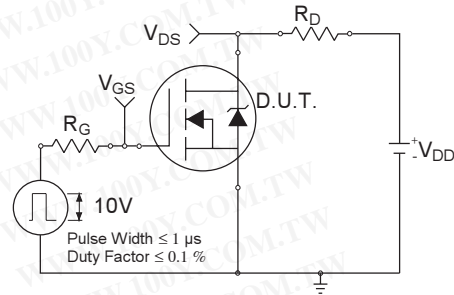
**Fig 7.** Typical Source-Drain Diode Forward Voltage



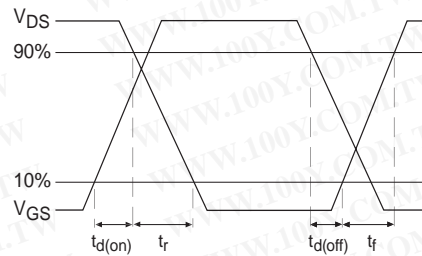
**Fig 8.** Maximum Safe Operating Area



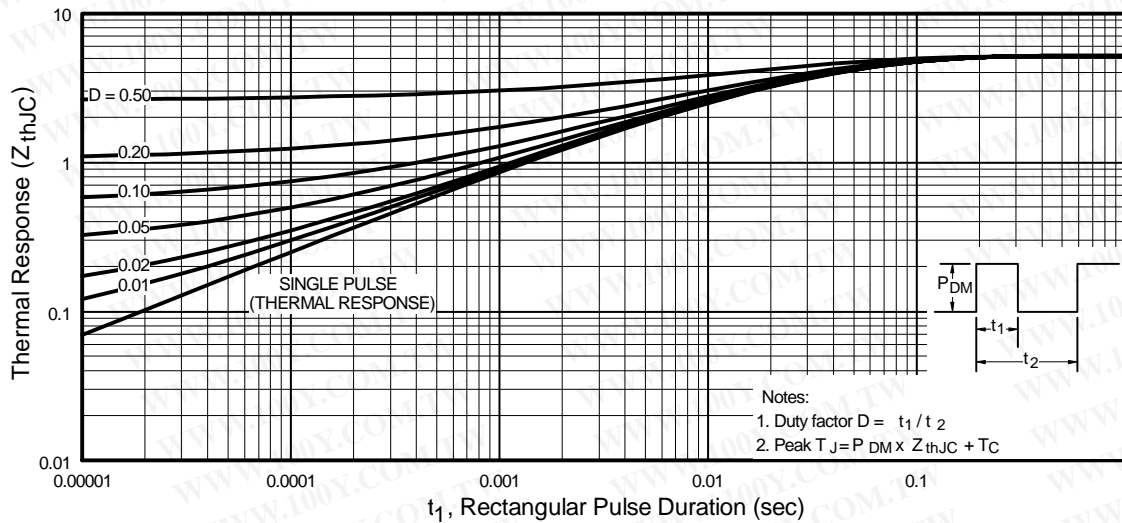
**Fig 9.** Maximum Drain Current Vs. Case Temperature



**Fig 10a.** Switching Time Test Circuit



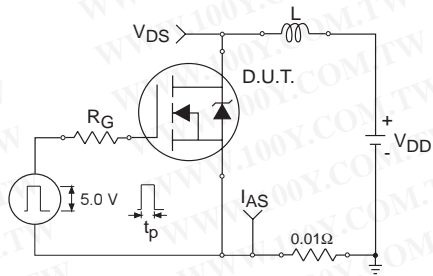
**Fig 10b.** Switching Time Waveforms



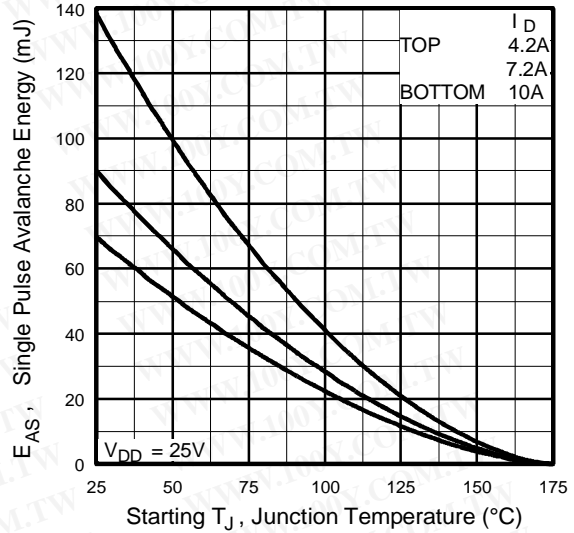
**Fig 11.** Maximum Effective Transient Thermal Impedance, Junction-to-Case

# IRFIZ24EPbF

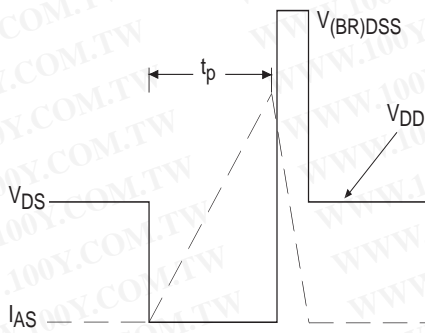
International  
**IR** Rectifier



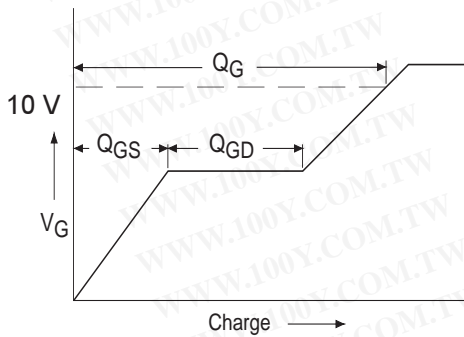
**Fig 12a.** Unclamped Inductive Test Circuit



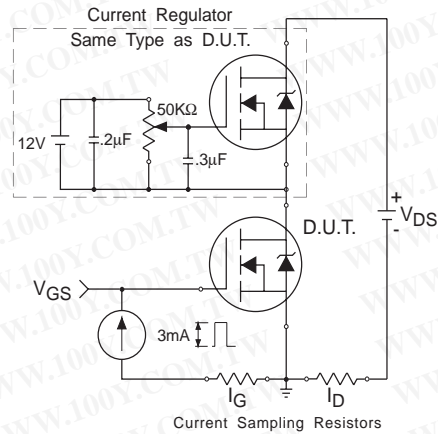
**Fig 12c.** Maximum Avalanche Energy Vs. Drain Current



**Fig 12b.** Unclamped Inductive Waveforms

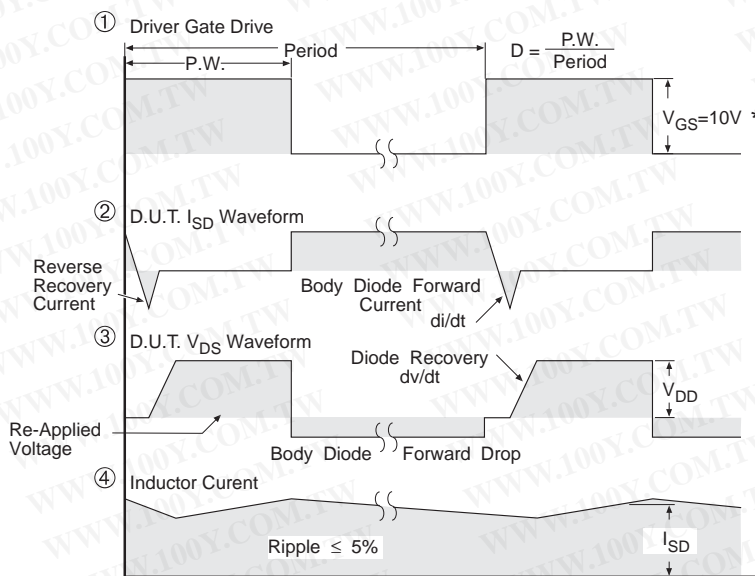
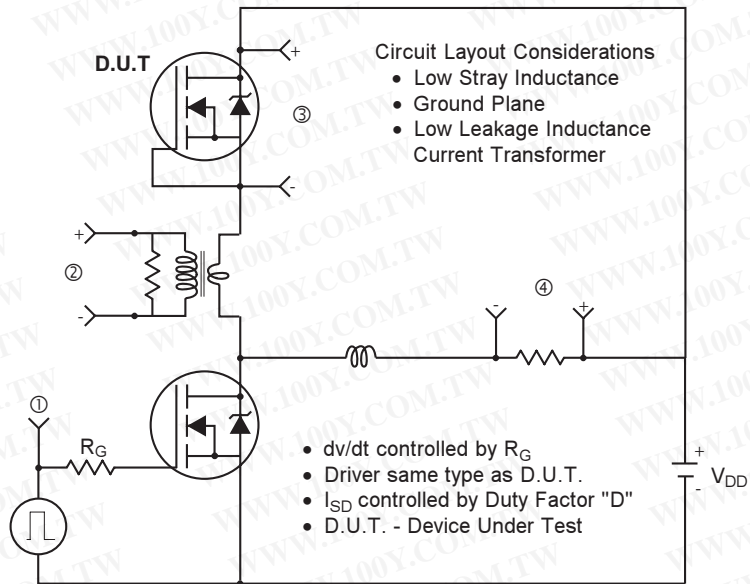


**Fig 13a.** Basic Gate Charge Waveform



**Fig 13b.** Gate Charge Test Circuit

## Peak Diode Recovery dv/dt Test Circuit



\*  $V_{GS} = 5V$  for Logic Level Devices

**Fig 14. For N-Channel HEXFETS**

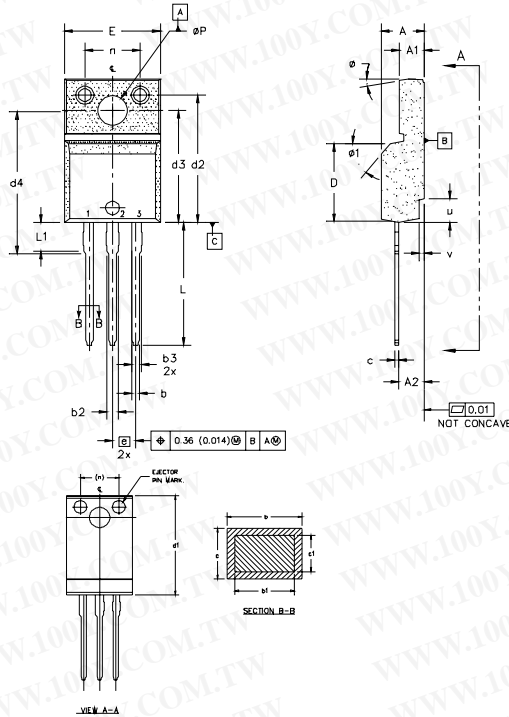
勝特力材料 886-3-5753170  
 勝特力电子(上海) 86-21-34970699  
 勝特力电子(深圳) 86-755-83298787  
 Http://www.100y.com.tw

# IRFIZ24EPbF

## TO-220 Full-Pak Package Outline

International  
**IR** Rectifier

Dimensions are shown in millimeters (inches)

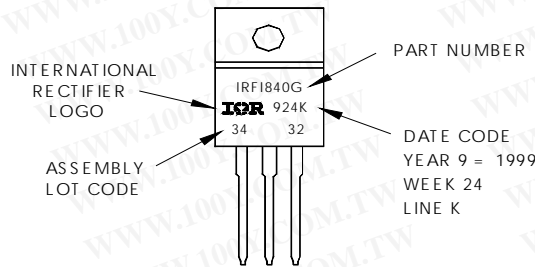


- NOTES:  
 1.0 DIMENSIONING AND TOLERANCING PER ASME Y14.5 M - 1994.  
 2.0 DIMENSIONS ARE SHOWN IN MILLIMETERS [INCHES].  
 3.0 LEAD DIMENSION AND FINISH UNCONTROLLED IN L1.  
 4.0 DIMENSION D & E DO NOT INCLUDE MOLD FLASH. MOLD FLASH SHALL NOT EXCEED 0.005" (0.127) PER SIDE. THESE DIMENSIONS ARE MEASURED AT THE OUTERMOST EXTREMES OF THE PLASTIC BODY.  
 5.0 DIMENSION b1 APPLY TO BASE METAL ONLY.  
 6.0 STEP OPTIONAL ON PLASTIC BODY DEFINED BY DIMENSIONS u & v.  
 7.0 CONTROLLING DIMENSION - INCHES.

SYMBOL	DIMENSIONS				NOTES	LEAD ASSIGNMENTS
	MILLIMETERS		INCHES			
A	4.57	4.83	0.180	0.190	5	HEXFEET 1 - GATE 2 - DRAIN 3 - SOURCE
A1	2.57	2.83	0.101	0.114		
A2	2.51	2.85	0.099	0.112		
b	0.622	0.89	0.024	0.035	4	IGBTs, CoPACK 1 - GATE 2 - COLLECTOR 3 - EMITTER
b1	0.622	0.838	0.024	0.033		
b2	1.229	1.400	0.048	0.055		
b3	1.229	1.400	0.048	0.055	4	
c	0.440	0.629	0.017	0.025		
c1	0.440	0.584	0.017	0.023		
D	8.65	9.80	0.341	0.386	4	
d1	15.80	16.12	0.622	0.635		
d2	13.97	14.22	0.550	0.560		
d3	12.30	12.92	0.484	0.509	4	
d4	8.64	9.91	0.340	0.390		
E	10.36	10.53	0.408	0.419		
e	2.54 BSC		0.100 BSC		3	
L	13.20	13.73	0.520	0.541		
L1	3.10	3.50	0.122	0.138		
n	6.05	6.15	0.238	0.242	6	
pP	2.40	2.50	0.094	0.098		
u	2.40	2.50	0.094	0.098		
v	0.40	0.50	0.016	0.020	6	
e	3"	7"	3"	7"		
e1	45°	45°	45°	45°		

## TO-220 Full-Pak Part Marking Information

EXAMPLE: THIS IS AN IRF1840G  
 WITH ASSEMBLY  
 LOT CODE 3432  
 ASSEMBLED ON WW 24 1999  
 IN THE ASSEMBLY LINE "K"  
**Note:** "P" in assembly line  
 position indicates "Lead-Free"



Data and specifications subject to change without notice.

International  
**IR** Rectifier

IR WORLD HEADQUARTERS: 233 Kansas St., El Segundo, California 90245, USA Tel: (310) 252-7105  
 TAC Fax: (310) 252-7903  
 Visit us at [www.irf.com](http://www.irf.com) for sales contact information. 07/04