

PDP MOSFET

IRFP4242PbF

Features

- Advanced process technology
- Key parameters optimized for PDP Sustain & Energy Recovery applications
- Low E_{PULSE} rating to reduce the power dissipation in Sustain & ER applications
- Low Q_G for fast response
- High repetitive peak current capability for reliable operation
- Short fall & rise times for fast switching
- 175°C operating junction temperature for improved ruggedness
- Repetitive avalanche capability for robustness and reliability

| Key Parameters | | |
|--|-----|----|
| V_{DS} min | 300 | V |
| V_{DS} (Avalanche) typ. | 360 | V |
| $R_{DS(ON)}$ typ. @ 10V | 49 | mΩ |
| I_{RP} max @ $T_C = 100^\circ\text{C}$ | 93 | A |
| T_J max | 175 | °C |

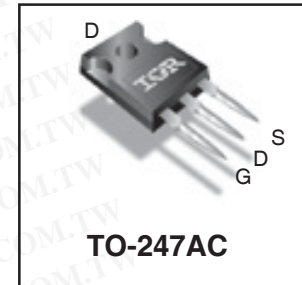
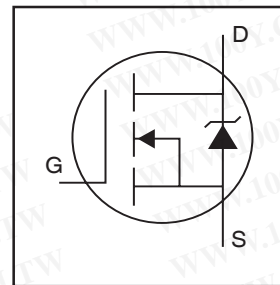

| G | D | S |
|------|-------|--------|
| Gate | Drain | Source |

Description

This HEXFET® Power MOSFET is specifically designed for Sustain; Energy Recovery & Pass switch applications in Plasma Display Panels. This MOSFET utilizes the latest processing techniques to achieve low on-resistance per silicon area and low E_{PULSE} rating. Additional features of this MOSFET are 175°C operating junction temperature and high repetitive peak current capability. These features combine to make this MOSFET a highly efficient, robust and reliable device for PDP driving applications.

Absolute Maximum Ratings

| | Parameter | Max. | Units |
|--------------------------------------|--|------------------|-------|
| V_{GS} | Gate-to-Source Voltage | ±30 | V |
| I_D @ $T_C = 25^\circ\text{C}$ | Continuous Drain Current, V_{GS} @ 10V | 46 | A |
| I_D @ $T_C = 100^\circ\text{C}$ | Continuous Drain Current, V_{GS} @ 10V | 33 | |
| I_{DM} | Pulsed Drain Current ① | 190 | |
| I_{RP} @ $T_C = 100^\circ\text{C}$ | Repetitive Peak Current ⑤ | 93 | |
| P_D @ $T_C = 25^\circ\text{C}$ | Power Dissipation | 430 | W |
| P_D @ $T_C = 100^\circ\text{C}$ | Power Dissipation | 210 | |
| | Linear Derating Factor | 2.9 | W/°C |
| T_J | Operating Junction and Storage Temperature Range | -40 to + 175 | °C |
| T_{STG} | | | |
| | Soldering Temperature for 10 seconds | 300 | |
| | Mounting Torque, 6-32 or M3 Screw | 10lb·in (1.1N·m) | N |

Thermal Resistance

| | Parameter | Typ. | Max. | Units |
|-----------------|--------------------|------|------|-------|
| $R_{\theta JC}$ | Junction-to-Case ④ | — | 0.35 | °C/W |

Notes ① through ⑤ are on page 8

IRFP4242PbF

勝特力材料 886-3-5753170
 勝特力电子(上海) 86-21-54151736
 勝特力电子(深圳) 86-755-83298787
[Http://www.100y.com.tw](http://www.100y.com.tw)

International
IR Rectifier

Electrical Characteristics @ $T_J = 25^\circ\text{C}$ (unless otherwise specified)

| | Parameter | Min. | Typ. | Max. | Units | Conditions |
|--------------------------------|--------------------------------------|------|------|------|-------|--|
| BV_{DSS} | Drain-to-Source Breakdown Voltage | 300 | — | — | V | $V_{GS} = 0V, I_D = 250\mu A$ |
| $\Delta BV_{DSS}/\Delta T_J$ | Breakdown Voltage Temp. Coefficient | — | 220 | — | mV/°C | Reference to $25^\circ\text{C}, I_D = 1mA$ |
| $R_{DS(on)}$ | Static Drain-to-Source On-Resistance | — | 49 | 59 | mΩ | $V_{GS} = 10V, I_D = 33A$ ③ |
| $V_{GS(th)}$ | Gate Threshold Voltage | 3.0 | — | 5.0 | V | $V_{DS} = V_{GS}, I_D = 250\mu A$ |
| $\Delta V_{GS(th)}/\Delta T_J$ | Gate Threshold Voltage Coefficient | — | -15 | — | mV/°C | |
| I_{DSS} | Drain-to-Source Leakage Current | — | — | 5.0 | μA | $V_{DS} = 240V, V_{GS} = 0V$ |
| | | — | — | 150 | | $V_{DS} = 240V, V_{GS} = 0V, T_J = 125^\circ\text{C}$ |
| I_{GSS} | Gate-to-Source Forward Leakage | — | — | 100 | nA | $V_{GS} = 20V$ |
| | Gate-to-Source Reverse Leakage | — | — | -100 | | $V_{GS} = -20V$ |
| g_{fs} | Forward Transconductance | 78 | — | — | S | $V_{DS} = 25V, I_D = 33A$ |
| Q_g | Total Gate Charge | — | 165 | 247 | nC | $V_{DD} = 150V, I_D = 33A, V_{GS} = 10V$ ③ |
| Q_{gd} | Gate-to-Drain Charge | — | 61 | — | | |
| $t_{d(on)}$ | Turn-On Delay Time | — | 40 | — | ns | $V_{DD} = 150V, V_{GS} = 10V$ ③ $I_D = 33A$ $R_G = 5.0\Omega$ See Fig. 22 |
| t_r | Rise Time | — | 71 | — | | |
| $t_{d(off)}$ | Turn-Off Delay Time | — | 72 | — | | |
| t_f | Fall Time | — | 48 | — | | |
| t_{st} | Shoot Through Blocking Time | 100 | — | — | ns | $V_{DD} = 240V, V_{GS} = 15V, R_G = 5.1\Omega$ |
| E_{PULSE} | Energy per Pulse | — | 1960 | — | μJ | $L = 220nH, C = 0.4\mu F, V_{GS} = 15V$ $V_{DS} = 240V, R_G = 4.7\Omega, T_J = 25^\circ\text{C}$ |
| | | — | 3740 | — | | $L = 220nH, C = 0.4\mu F, V_{GS} = 15V$ $V_{DS} = 240V, R_G = 4.7\Omega, T_J = 100^\circ\text{C}$ |
| C_{iss} | Input Capacitance | — | 7370 | — | pF | $V_{GS} = 0V$ |
| C_{oss} | Output Capacitance | — | 520 | — | | $V_{DS} = 25V$ |
| C_{rss} | Reverse Transfer Capacitance | — | 220 | — | | $f = 1.0MHz,$ See Fig.9 |
| $C_{oss\ eff.}$ | Effective Output Capacitance | — | 320 | — | | $V_{GS} = 0V, V_{DS} = 0V \text{ to } 240V$ |
| L_D | Internal Drain Inductance | — | 5.0 | — | nH | Between lead, 6mm (0.25in.) from package and center of die contact |
| L_S | Internal Source Inductance | — | 13 | — | | |



Avalanche Characteristics

| | Parameter | Typ. | Max. | Units |
|---------------------|---------------------------------|------|------|-------|
| E_{AS} | Single Pulse Avalanche Energy ② | — | 700 | mJ |
| E_{AR} | Repetitive Avalanche Energy ① | — | 43 | mJ |
| $V_{DS(Avalanche)}$ | Repetitive Avalanche Voltage ① | 360 | — | V |
| I_{AS} | Avalanche Current ② | — | 33 | A |

Diode Characteristics

| | Parameter | Min. | Typ. | Max. | Units | Conditions |
|--------------------------------|---|------|------|------|-------|---|
| $I_S @ T_C = 25^\circ\text{C}$ | Continuous Source Current (Body Diode) | — | — | 46 | A | MOSFET symbol showing the integral reverse p-n junction diode. |
| I_{SM} | Pulsed Source Current (Body Diode) ① | — | — | 190 | | |
| V_{SD} | Diode Forward Voltage | — | — | 1.0 | V | $T_J = 25^\circ\text{C}, I_S = 33A, V_{GS} = 0V$ ③ |
| t_{rr} | Reverse Recovery Time | — | 300 | 450 | ns | $T_J = 25^\circ\text{C}, I_F = 33A, V_{DD} = 50V$ |
| Q_{rr} | Reverse Recovery Charge | — | 2330 | 3500 | nC | $di/dt = 100A/\mu s$ ③ |

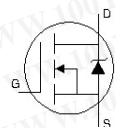

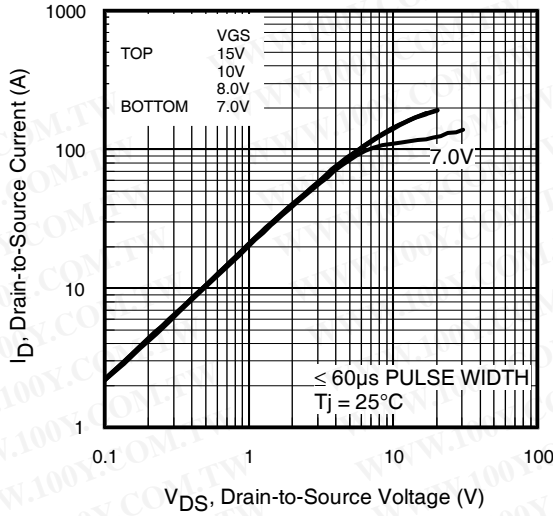

Fig 1. Typical Output Characteristics

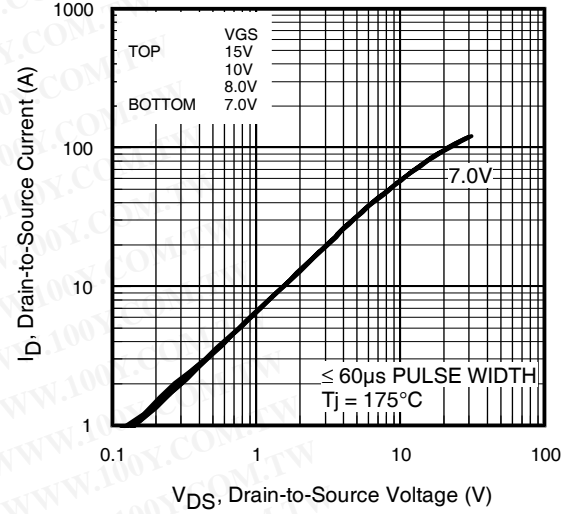

Fig 2. Typical Output Characteristics

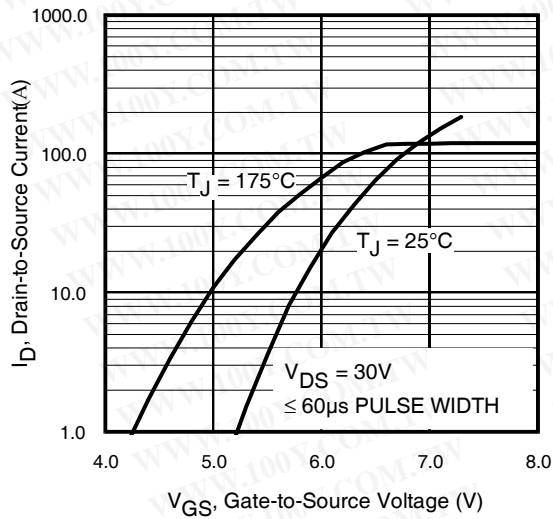

Fig 3. Typical Transfer Characteristics

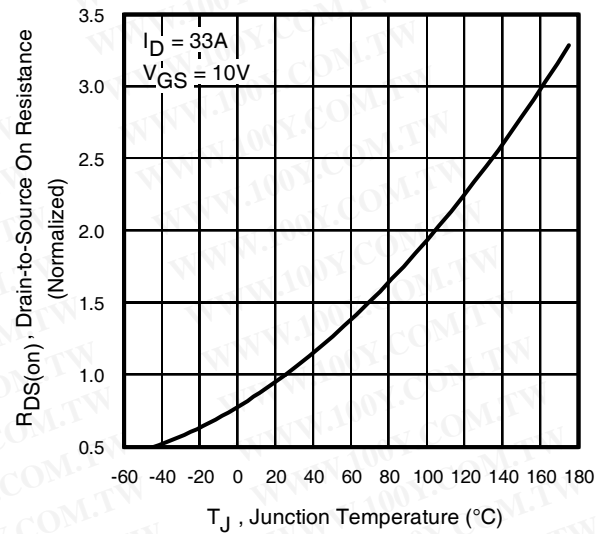

Fig 4. Normalized On-Resistance vs. Temperature

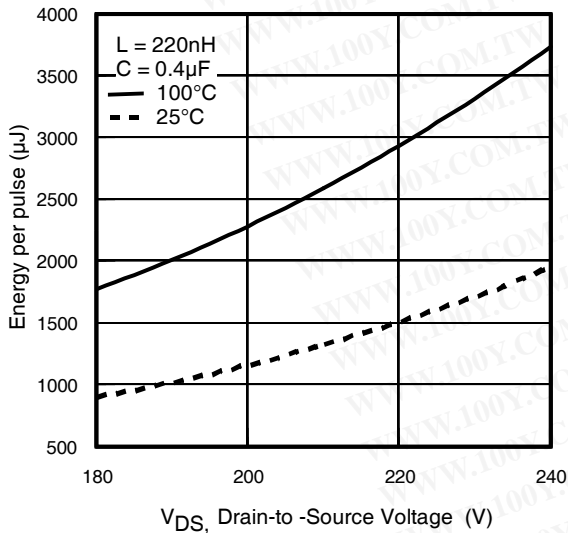

Fig 5. Typical E_{PULSE} vs. Drain-to-Source Voltage

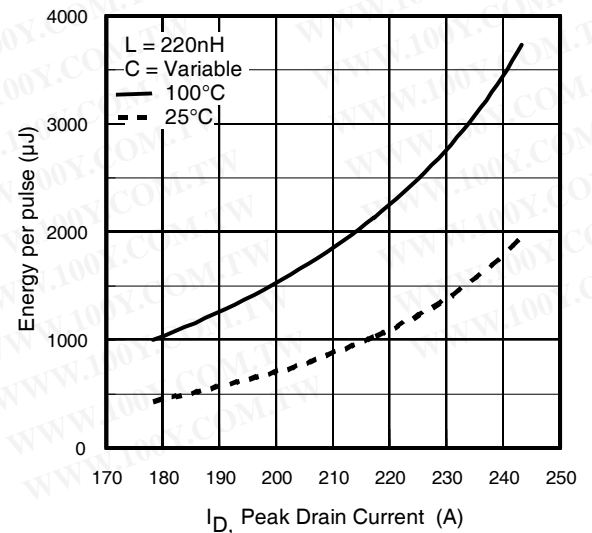

Fig 6. Typical E_{PULSE} vs. Drain Current

IRFP4242PbF

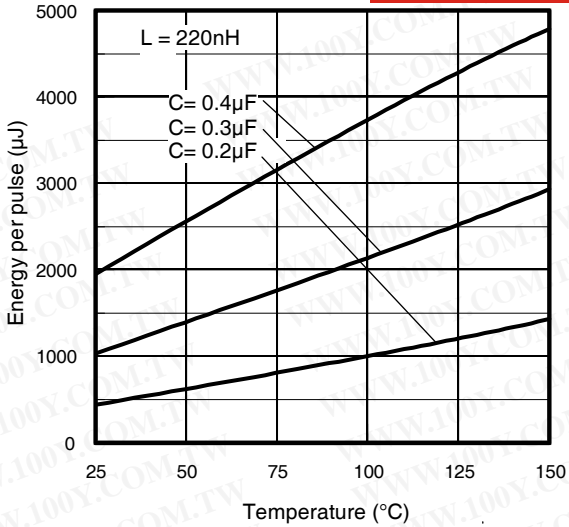

Fig 7. Typical E_{PULSE} vs. Temperature

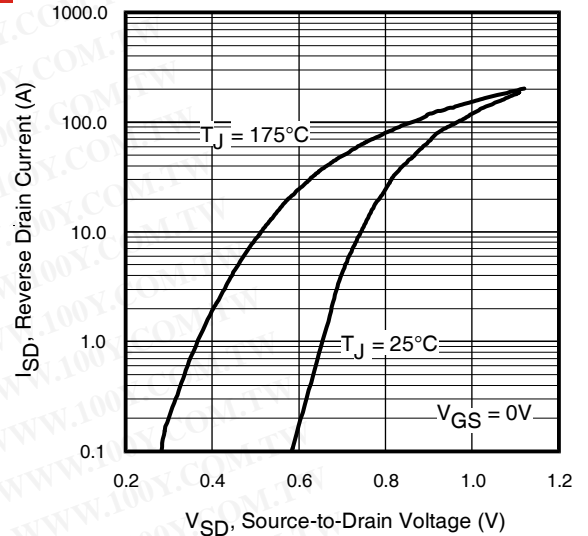

Fig 8. Typical Source-Drain Diode Forward Voltage

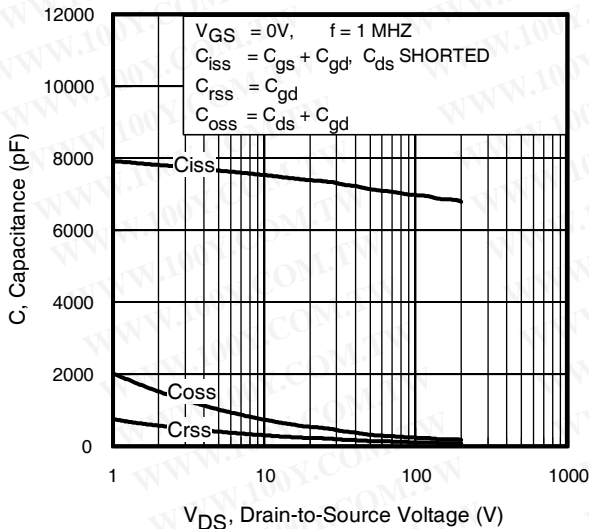

Fig 9. Typical Capacitance vs. Drain-to-Source Voltage

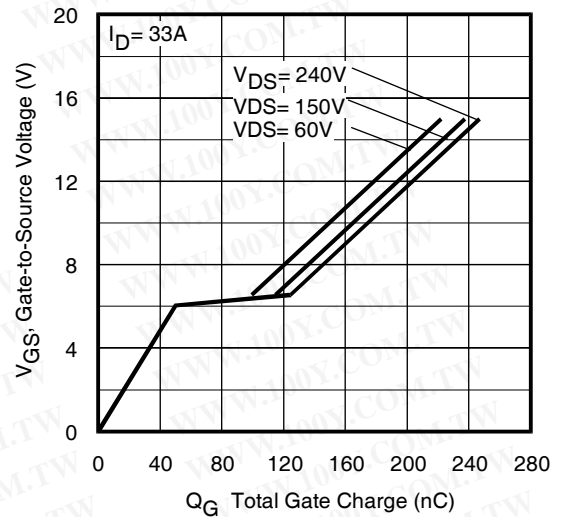

Fig 10. Typical Gate Charge vs. Gate-to-Source Voltage

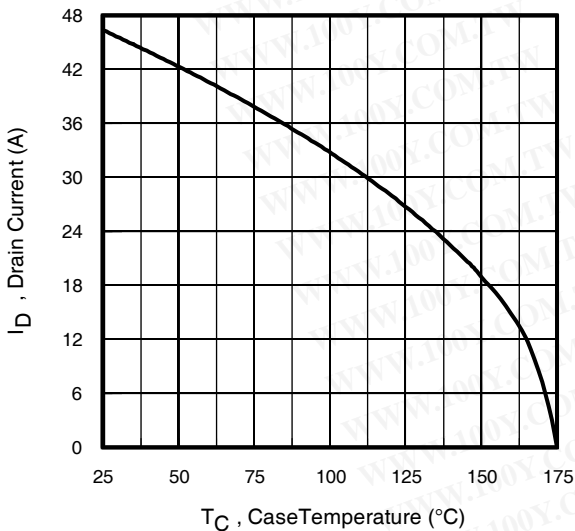

Fig 11. Maximum Drain Current vs. Case Temperature

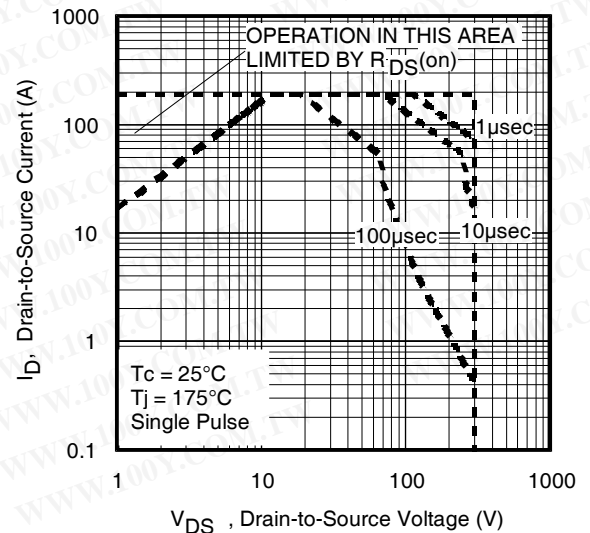

Fig 12. Maximum Safe Operating Area

IRFP4242PbF

International Rectifier

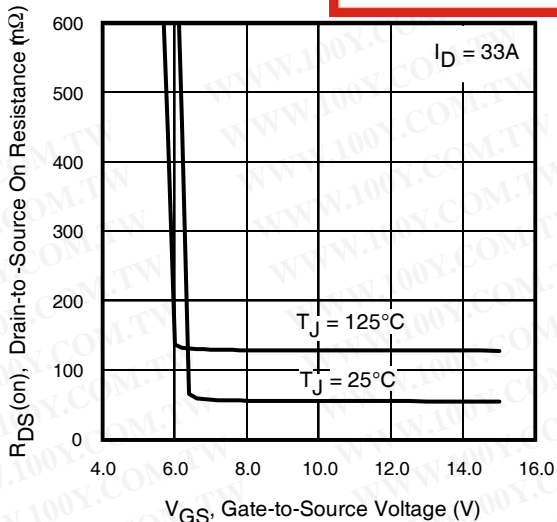

Fig 13. On-Resistance Vs. Gate Voltage

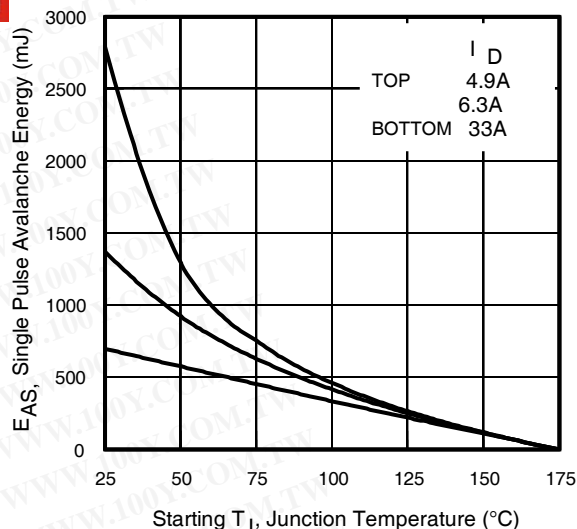

Fig 14. Maximum Avalanche Energy Vs. Temperature

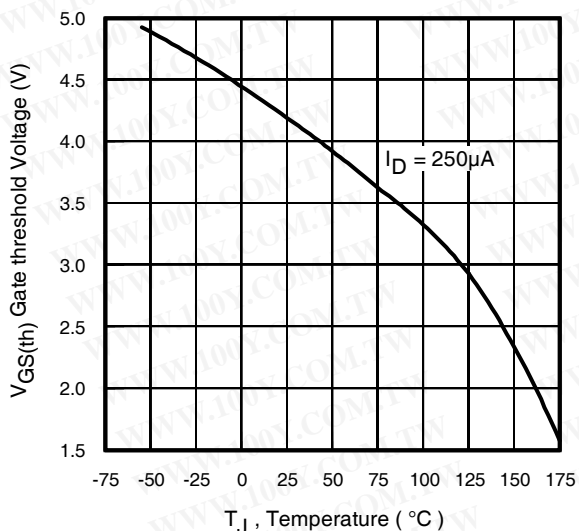

Fig 15. Threshold Voltage vs. Temperature

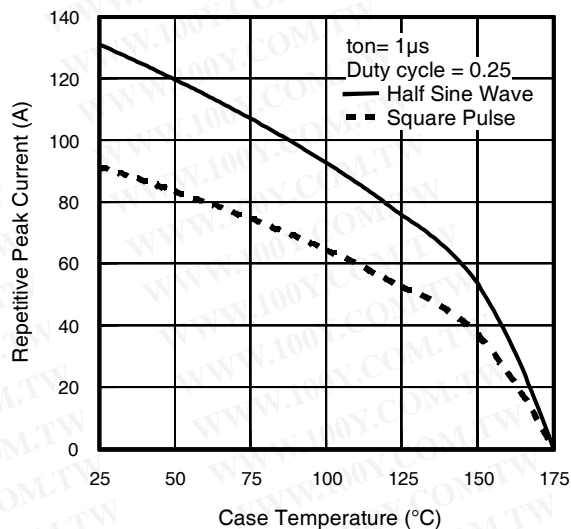

Fig 16. Typical Repetitive peak Current vs. Case temperature

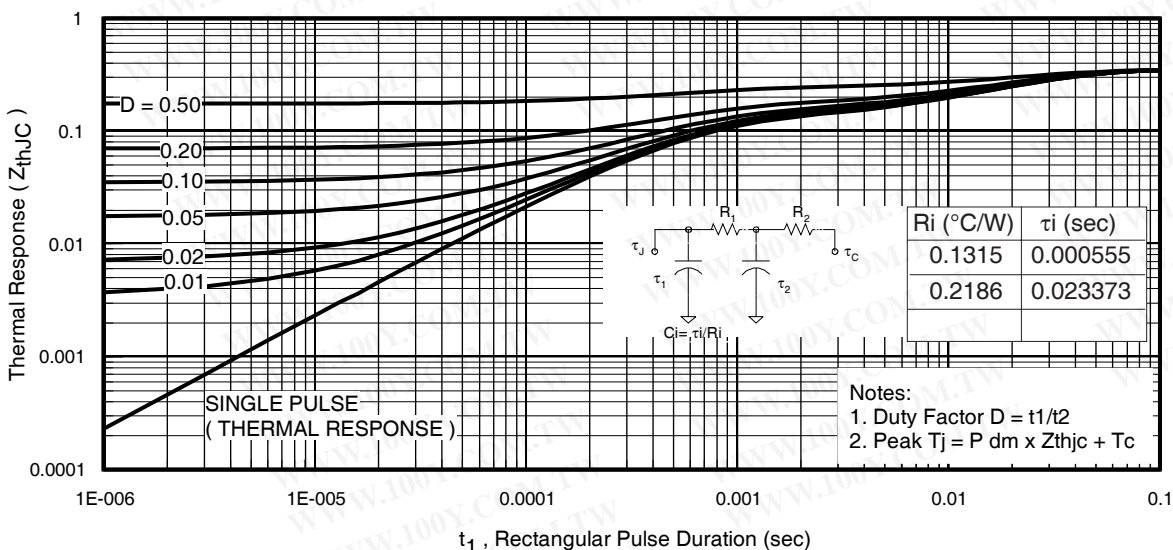

Fig 17. Maximum Effective Transient Thermal Impedance, Junction-to-Case

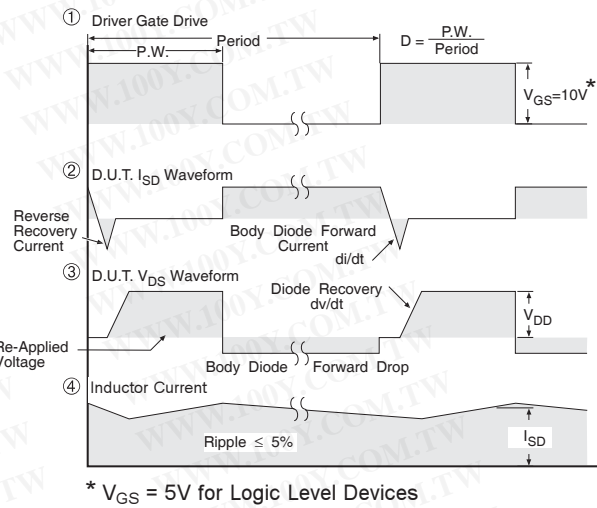
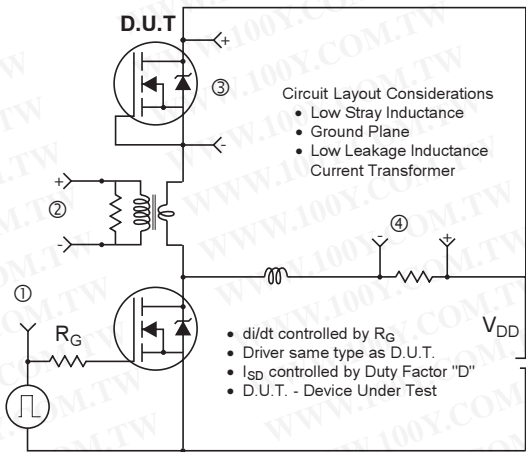

Fig 18. Diode Reverse Recovery Test Circuit for N-Channel HEXFET[®] Power MOSFETs

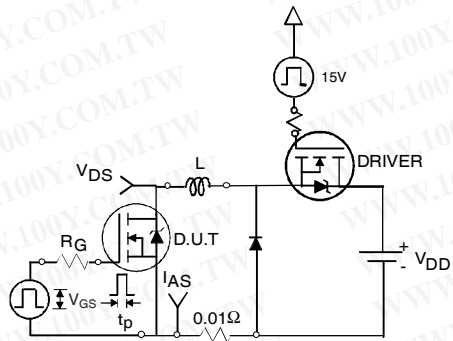

Fig 19a. Unclamped Inductive Test Circuit

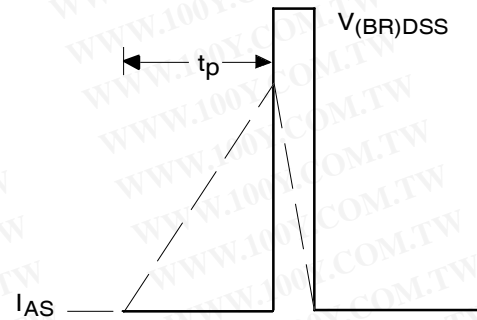

Fig 19b. Unclamped Inductive Waveforms

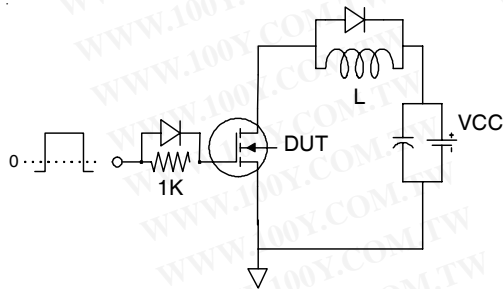

Fig 20a. Gate Charge Test Circuit

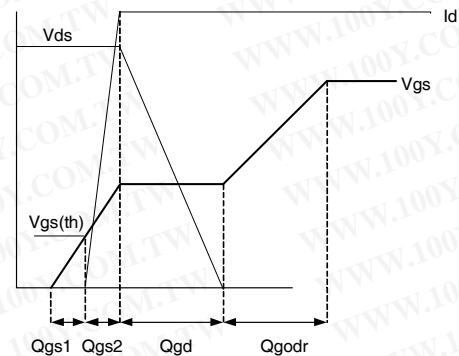

Fig 20b. Gate Charge Waveform

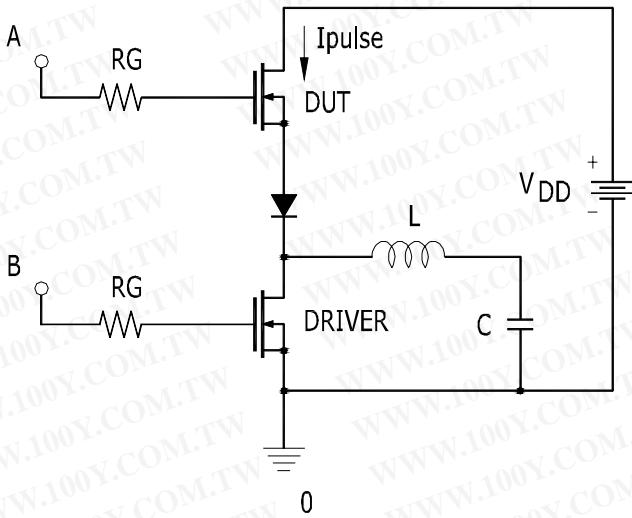

Fig 21a. t_{st} and E_{PULSE} Test Circuit

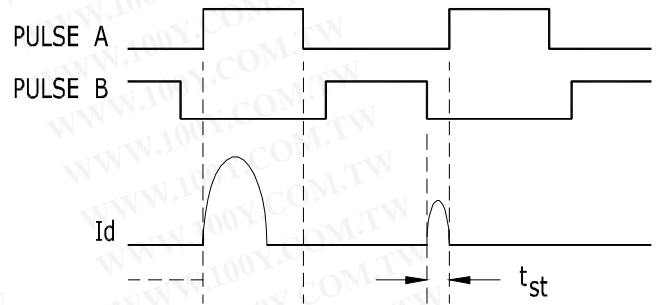

Fig 21b. t_{st} Test Waveforms

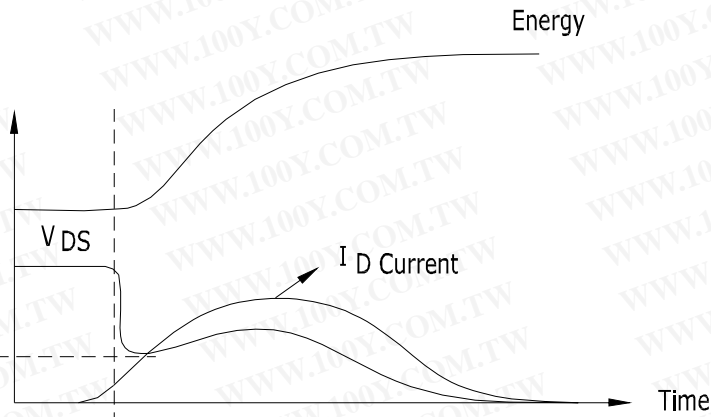

Fig 21c. E_{PULSE} Test Waveforms

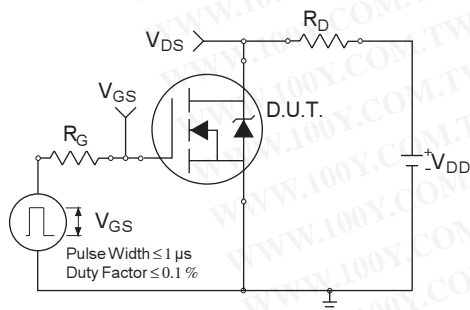

Fig 22a. Switching Time Test Circuit

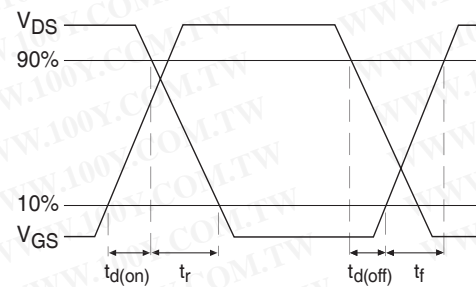
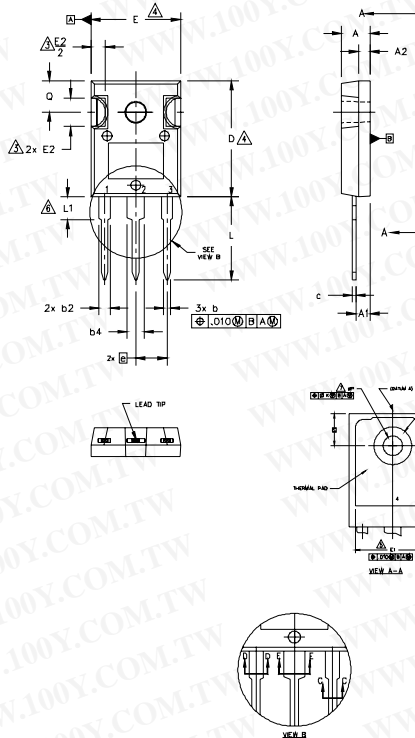

Fig 22b. Switching Time Waveforms

IRFP4242PbF

TO-247AC Package Outline

Dimensions are shown in millimeters (inches)



勝特力材料 886-3-5753170
 勝特力电子(上海) 86-21-54151736
 勝特力电子(深圳) 86-755-83298787
[Http://www.100y.com.tw](http://www.100y.com.tw)

International
IR Rectifier

- NOTES:
1. DIMENSIONING AND TOLERANCING AS PER ASME Y14.5M 1994.
 2. DIMENSIONS ARE SHOWN IN INCHES.
 3. CONTOUR OF SLOT OPTIONAL.
 4. DIMENSION D & E DO NOT INCLUDE MOLD FLASH. MOLD FLASH SHALL NOT EXCEED .005" (0.127) PER SIDE. THESE DIMENSIONS ARE MEASURED AT THE OUTERMOST EXTREMES OF THE PLASTIC BODY.
 5. THERMAL PAD CONTOUR OPTIONAL WITHIN DIMENSIONS D1 & E1.
 6. LEAD FINISH UNCONTROLLED IN L1.
 7. ØP TO HAVE A MAXIMUM DRAFT ANGLE OF 1.5° TO THE TOP OF THE PART WITH A MAXIMUM HOLE DIAMETER OF .154 INCH.
 8. OUTLINE CONFORMS TO JEDEC OUTLINE TO-247AC.

| SYMBOL | DIMENSIONS | | | | NOTES |
|--------|------------|------|-------------|-------|-------|
| | INCHES | | MILLIMETERS | | |
| | MIN. | MAX. | MIN. | MAX. | |
| A | .183 | .209 | 4.65 | 5.31 | |
| A1 | .087 | .102 | 2.21 | 2.59 | |
| A2 | .059 | .098 | 1.50 | 2.49 | |
| b | .039 | .055 | 0.99 | 1.40 | |
| b1 | .039 | .053 | 0.99 | 1.35 | |
| b2 | .065 | .094 | 1.65 | 2.39 | |
| b3 | .065 | .092 | 1.65 | 2.34 | |
| b4 | .102 | .135 | 2.59 | 3.43 | |
| b5 | .102 | .133 | 2.59 | 3.38 | |
| c | .015 | .035 | 0.38 | 0.89 | |
| c1 | .015 | .033 | 0.38 | 0.84 | |
| D | .776 | .815 | 19.71 | 20.70 | 4 |
| D1 | .515 | - | 13.08 | - | 5 |
| D2 | .020 | .053 | 0.51 | 1.35 | |
| E | .602 | .625 | 15.29 | 15.87 | 4 |
| E1 | .530 | - | 13.46 | - | |
| E2 | .178 | .216 | 4.52 | 5.49 | |
| e | .215 BSC | | 5.46 BSC | | |
| Øk | .010 | | 0.25 | | |
| L | .559 | .634 | 14.20 | 16.10 | |
| L1 | .146 | .169 | 3.71 | 4.29 | |
| ØP | .140 | .144 | 3.56 | 3.66 | |
| ØP1 | - | .291 | - | 7.39 | |
| Q | .209 | .224 | 5.31 | 5.69 | |
| S | .217 BSC | | 5.51 BSC | | |

LEAD ASSIGNMENTS

- HEXFET
 1 - GATE
 2 - DRAIN
 3 - SOURCE
 4 - DRAIN

IGBTs, CoPACK

- 1 - GATE
 2 - COLLECTOR
 3 - EMITTER
 4 - COLLECTOR

DIODES

- 1 - ANODE/OPEN
 2 - CATHODE
 3 - ANODE

TO-247AC Part Marking Information

EXAMPLE: THIS IS AN IRFPE30
 WITH ASSEMBLY
 LOT CODE 5657
 ASSEMBLED ON WW 35, 2001
 IN THE ASSEMBLY LINE "H"

Note: "P" in assembly line position indicates "Lead-Free"

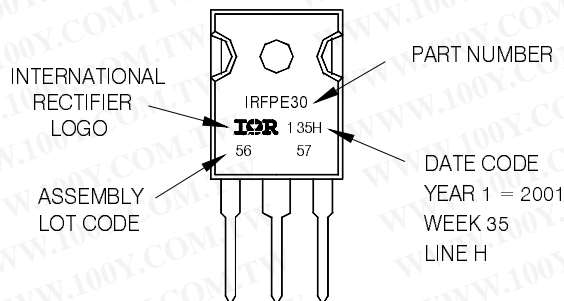

TO-247AC package is not recommended for Surface Mount Application.

Notes:

- ① Repetitive rating; pulse width limited by max. junction temperature.
- ② Starting $T_J = 25^\circ\text{C}$, $L = 1.28\text{mH}$, $R_G = 25\Omega$, $I_{AS} = 33\text{A}$.
- ③ Pulse width $\leq 400\mu\text{s}$; duty cycle $\leq 2\%$.
- ④ R_{θ} is measured at T_J of approximately 90°C .
- ⑤ Half sine wave with duty cycle = 0.25, $t_{on} = 1\mu\text{sec}$.

Note: For the most current drawing please refer to IR website at: <http://www.irf.com/package/>

Data and specifications subject to change without notice.
 This product has been designed for the Industrial market.
 Qualification Standards can be found on IR's Web site.

International
IR Rectifier

IR WORLD HEADQUARTERS: 233 Kansas St., El Segundo, California 90245, USA Tel: (310) 252-7105
 TAC Fax: (310) 252-7903

Visit us at www.irf.com for sales contact information.09/2007

www.irf.com