

勝特力材料 886-3-5753170  
勝特力电子(上海) 86-21-34970699  
勝特力电子(深圳) 86-755-83298787  
Http://www.100y.com.tw

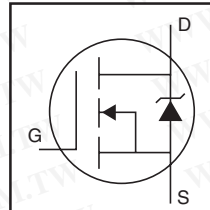
# IRFB3806PbF IRFS3806PbF IRFSL3806PbF

## Applications

- High Efficiency Synchronous Rectification in SMPS
- Uninterruptible Power Supply
- High Speed Power Switching
- Hard Switched and High Frequency Circuits

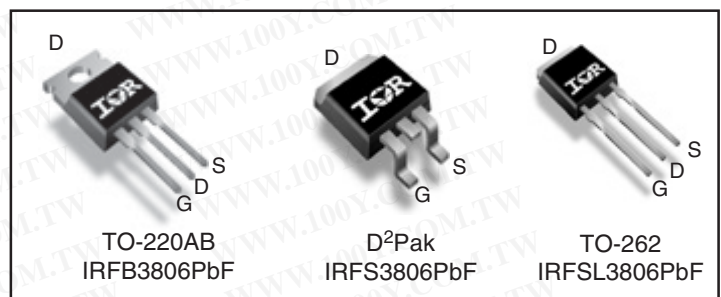
## Benefits

- Improved Gate, Avalanche and Dynamic dv/dt Ruggedness
- Fully Characterized Capacitance and Avalanche SOA
- Enhanced body diode dV/dt and dI/dt Capability



HEXFET® Power MOSFET

$V_{DSS}$		<b>60V</b>
$R_{DS(on)}$	typ.	<b>12.6mΩ</b>
	max.	<b>15.8mΩ</b>
$I_D$		<b>43A</b>



<b>G</b>	<b>D</b>	<b>S</b>
Gate	Drain	Source

## Absolute Maximum Ratings

Symbol	Parameter	Max.	Units
$I_D @ T_C = 25^\circ\text{C}$	Continuous Drain Current, $V_{GS} @ 10\text{V}$	43	A
$I_D @ T_C = 100^\circ\text{C}$	Continuous Drain Current, $V_{GS} @ 10\text{V}$	31	
$I_{DM}$	Pulsed Drain Current ①	170	
$P_D @ T_C = 25^\circ\text{C}$	Maximum Power Dissipation	71	W
	Linear Derating Factor	0.47	W/°C
$V_{GS}$	Gate-to-Source Voltage	$\pm 20$	V
dv/dt	Peak Diode Recovery ③	24	V/ns
$T_J$ $T_{STG}$	Operating Junction and Storage Temperature Range	-55 to + 175	°C
	Soldering Temperature, for 10 seconds (1.6mm from case)	300	
	Mounting torque, 6-32 or M3 screw	10lb·in (1.1N·m)	

## Avalanche Characteristics

$E_{AS}$ (Thermally limited)	Single Pulse Avalanche Energy ②	73	mJ
$I_{AR}$	Avalanche Current ①	25	A
$E_{AR}$	Repetitive Avalanche Energy ④	7.1	mJ

## Thermal Resistance

Symbol	Parameter	Typ.	Max.	Units
$R_{\theta JC}$	Junction-to-Case ⑤	—	2.12	°C/W
$R_{\theta CS}$	Case-to-Sink, Flat Greased Surface, TO-220	0.50	—	
$R_{\theta JA}$	Junction-to-Ambient, TO-220 ⑦⑧	—	62	
$R_{\theta JA}$	Junction-to-Ambient (PCB Mount) , D²Pak ⑦⑧	—	40	

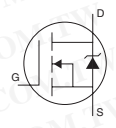
**Static @ T<sub>J</sub> = 25°C (unless otherwise specified)**

Symbol	Parameter	Min.	Typ.	Max.	Units	Conditions
V <sub>(BR)DSS</sub>	Drain-to-Source Breakdown Voltage	60	—	—	V	V <sub>GS</sub> = 0V, I <sub>D</sub> = 250μA
ΔV <sub>(BR)DSS</sub> /ΔT <sub>J</sub>	Breakdown Voltage Temp. Coefficient	—	0.075	—	V/°C	Reference to 25°C, I <sub>D</sub> = 5mA①
R <sub>DS(on)</sub>	Static Drain-to-Source On-Resistance	—	12.6	15.8	mΩ	V <sub>GS</sub> = 10V, I <sub>D</sub> = 25A ④
V <sub>GS(th)</sub>	Gate Threshold Voltage	2.0	—	4.0	V	V <sub>DS</sub> = V <sub>GS</sub> , I <sub>D</sub> = 50μA
I <sub>DSS</sub>	Drain-to-Source Leakage Current	—	—	20	μA	V <sub>DS</sub> = 60V, V <sub>GS</sub> = 0V
		—	—	250		V <sub>DS</sub> = 48V, V <sub>GS</sub> = 0V, T <sub>J</sub> = 125°C
I <sub>GSS</sub>	Gate-to-Source Forward Leakage	—	—	100	nA	V <sub>GS</sub> = 20V
	Gate-to-Source Reverse Leakage	—	—	-100		V <sub>GS</sub> = -20V

**Dynamic @ T<sub>J</sub> = 25°C (unless otherwise specified)**

Symbol	Parameter	Min.	Typ.	Max.	Units	Conditions
g <sub>fs</sub>	Forward Transconductance	41	—	—	S	V <sub>DS</sub> = 10V, I <sub>D</sub> = 25A
Q <sub>g</sub>	Total Gate Charge	—	22	30	nC	I <sub>D</sub> = 25A
Q <sub>gs</sub>	Gate-to-Source Charge	—	5.0	—		V <sub>DS</sub> = 30V
Q <sub>gd</sub>	Gate-to-Drain ("Miller") Charge	—	6.3	—		V <sub>GS</sub> = 10V ④
Q <sub>sync</sub>	Total Gate Charge Sync. (Q <sub>g</sub> - Q <sub>gd</sub> )	—	28.3	—		I <sub>D</sub> = 25A, V <sub>DS</sub> = 0V, V <sub>GS</sub> = 10V
R <sub>G(int)</sub>	Internal Gate Resistance	—	0.79	—	Ω	
t <sub>d(on)</sub>	Turn-On Delay Time	—	6.3	—	ns	V <sub>DD</sub> = 39V
t <sub>r</sub>	Rise Time	—	40	—		I <sub>D</sub> = 25A
t <sub>d(off)</sub>	Turn-Off Delay Time	—	49	—		R <sub>G</sub> = 20Ω
t <sub>f</sub>	Fall Time	—	47	—		V <sub>GS</sub> = 10V ④
C <sub>iss</sub>	Input Capacitance	—	1150	—		V <sub>GS</sub> = 0V
C <sub>oss</sub>	Output Capacitance	—	130	—		V <sub>DS</sub> = 50V
C <sub>rss</sub>	Reverse Transfer Capacitance	—	67	—	pF	f = 1.0MHz
C <sub>oss</sub> eff. (ER)	Effective Output Capacitance (Energy Related)⑥	—	190	—		V <sub>GS</sub> = 0V, V <sub>DS</sub> = 0V to 60V ⑥
C <sub>oss</sub> eff. (TR)	Effective Output Capacitance (Time Related)⑤	—	230	—		V <sub>GS</sub> = 0V, V <sub>DS</sub> = 0V to 60V ⑤

**Diode Characteristics**

Symbol	Parameter	Min.	Typ.	Max.	Units	Conditions
I <sub>S</sub>	Continuous Source Current (Body Diode)	—	—	43	A	MOSFET symbol showing the integral reverse p-n junction diode. 
I <sub>SM</sub>	Pulsed Source Current (Body Diode) ①	—	—	170		
V <sub>SD</sub>	Diode Forward Voltage	—	—	1.3	V	T <sub>J</sub> = 25°C, I <sub>S</sub> = 25A, V <sub>GS</sub> = 0V ④
t <sub>rr</sub>	Reverse Recovery Time	—	22	33	ns	T <sub>J</sub> = 25°C V <sub>R</sub> = 51V,
		—	26	39		T <sub>J</sub> = 125°C I <sub>F</sub> = 25A
Q <sub>rr</sub>	Reverse Recovery Charge	—	17	26	nC	T <sub>J</sub> = 25°C di/dt = 100A/μs ④
		—	24	36		T <sub>J</sub> = 125°C
I <sub>RRM</sub>	Reverse Recovery Current	—	1.4	—	A	T <sub>J</sub> = 25°C
t <sub>on</sub>	Forward Turn-On Time	Intrinsic turn-on time is negligible (turn-on is dominated by LS+LD)				

**Notes:**

- ① Repetitive rating; pulse width limited by max. junction temperature.
- ② Limited by T<sub>Jmax</sub>, starting T<sub>J</sub> = 25°C, L = 0.23mH  
R<sub>G</sub> = 25Ω, I<sub>AS</sub> = 25A, V<sub>GS</sub> = 10V. Part not recommended for use above this value.
- ③ I<sub>SD</sub> ≤ 25A, di/dt ≤ 1580A/μs, V<sub>DD</sub> ≤ V<sub>(BR)DSS</sub>, T<sub>J</sub> ≤ 175°C.
- ④ Pulse width ≤ 400μs; duty cycle ≤ 2%.
- ⑤ C<sub>oss</sub> eff. (TR) is a fixed capacitance that gives the same charging time as C<sub>oss</sub> while V<sub>DS</sub> is rising from 0 to 80% V<sub>DSS</sub>.
- ⑥ C<sub>oss</sub> eff. (ER) is a fixed capacitance that gives the same energy as C<sub>oss</sub> while V<sub>DS</sub> is rising from 0 to 80% V<sub>DSS</sub>.
- ⑦ When mounted on 1" square PCB (FR-4 or G-10 Material). For recommended footprint and soldering techniques refer to application note #AN-994.
- ⑧ R<sub>θ</sub> is measured at T<sub>J</sub> approximately 90°C.

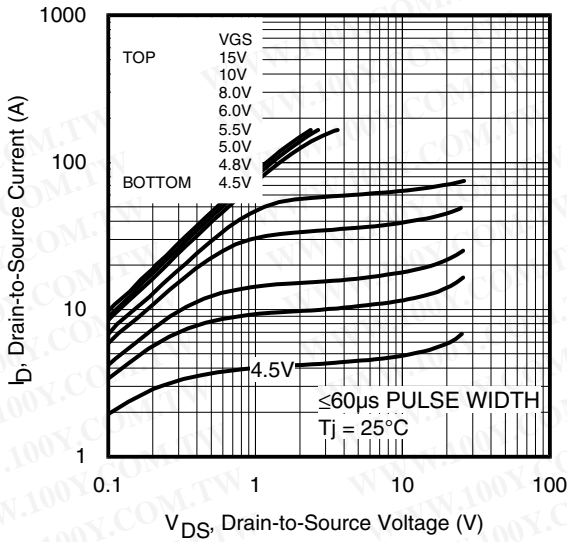


Fig 1. Typical Output Characteristics

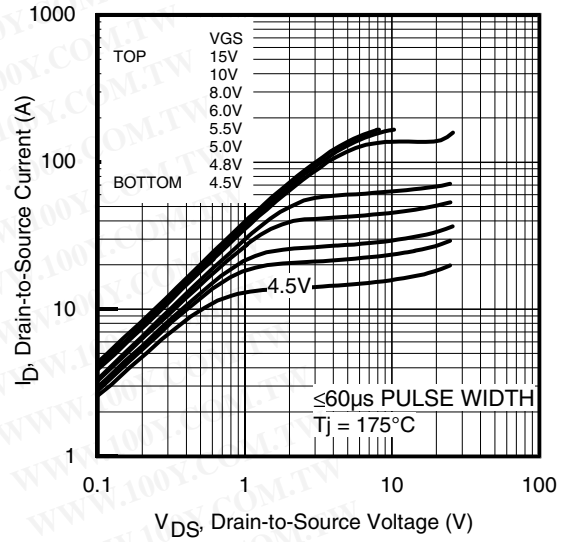


Fig 2. Typical Output Characteristics

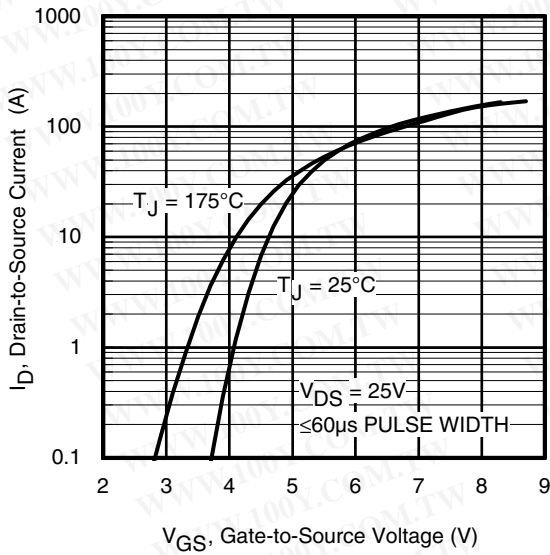


Fig 3. Typical Transfer Characteristics

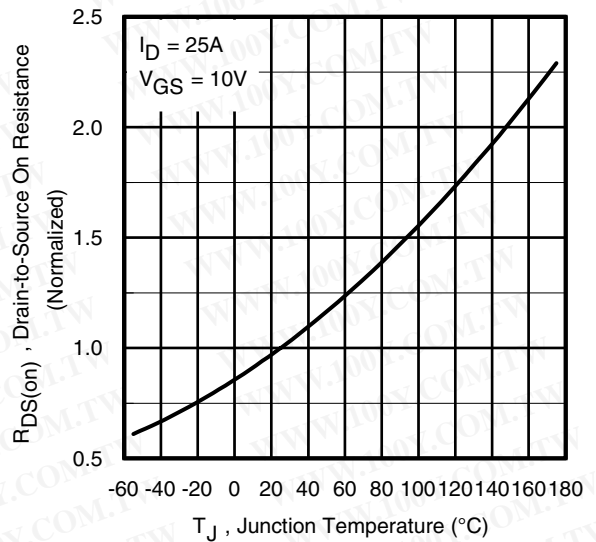


Fig 4. Normalized On-Resistance vs. Temperature

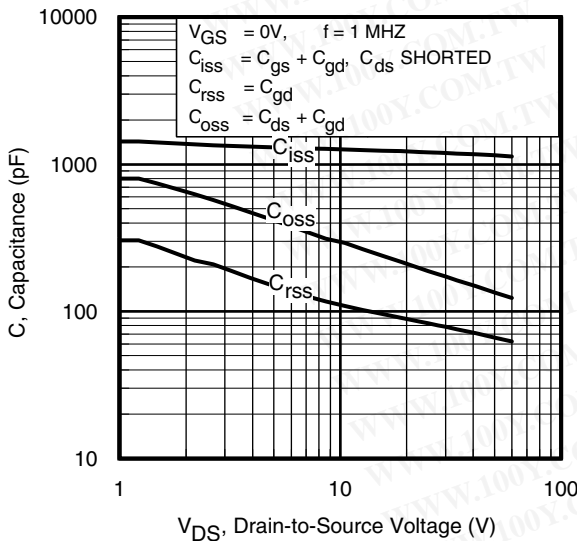


Fig 5. Typical Capacitance vs. Drain-to-Source Voltage

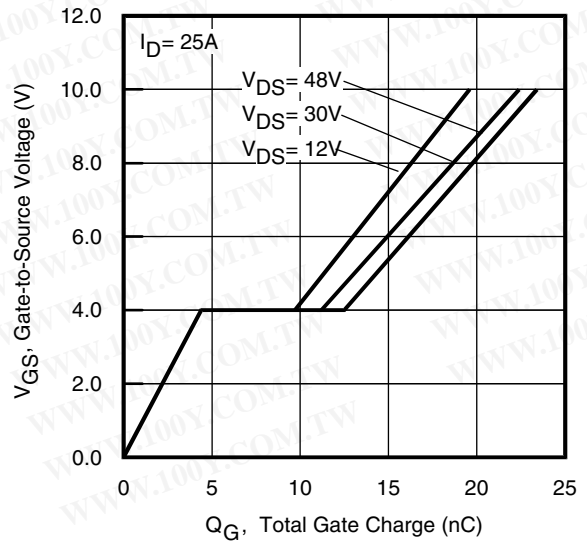


Fig 6. Typical Gate Charge vs. Gate-to-Source Voltage

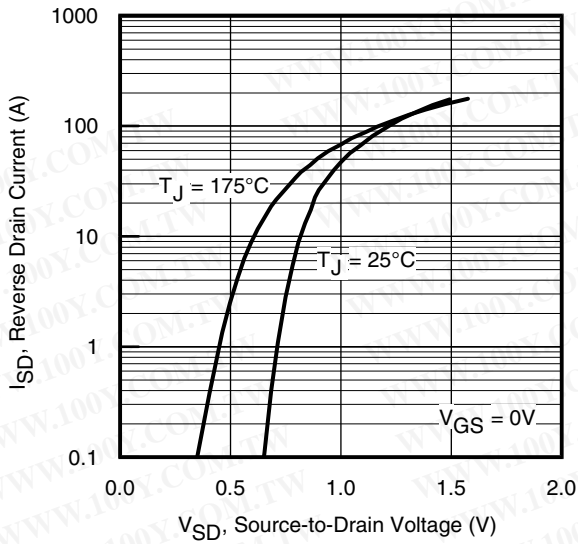


Fig 7. Typical Source-Drain Diode Forward Voltage

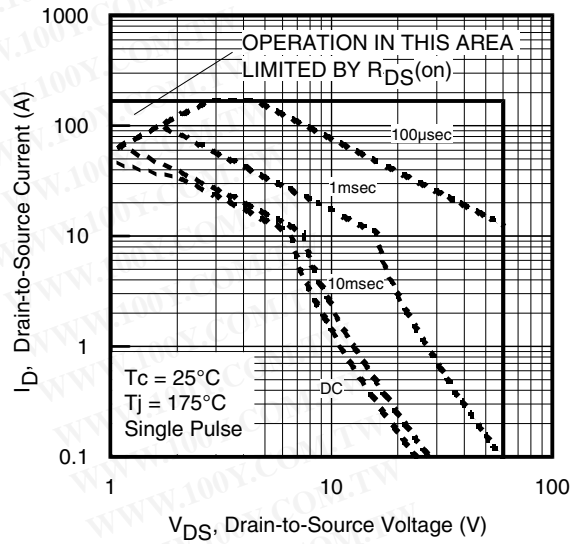


Fig 8. Maximum Safe Operating Area

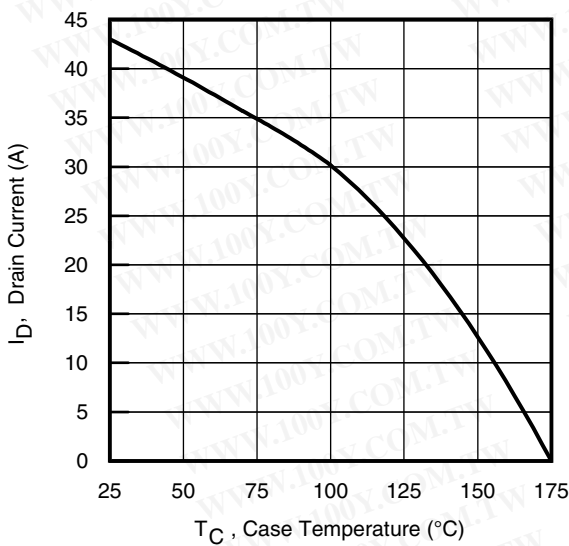


Fig 9. Maximum Drain Current vs. Case Temperature

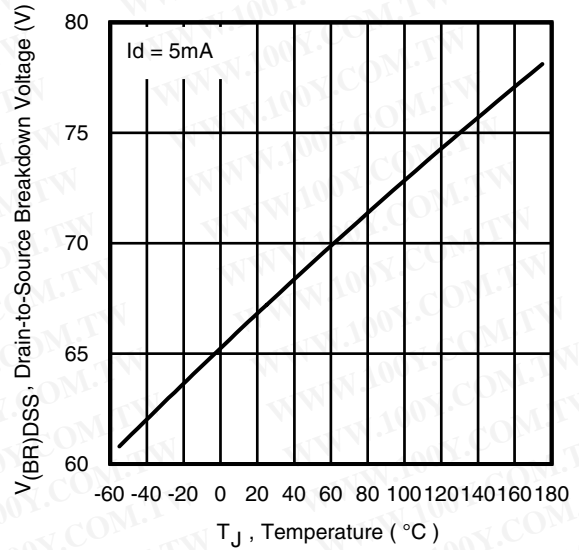


Fig 10. Drain-to-Source Breakdown Voltage

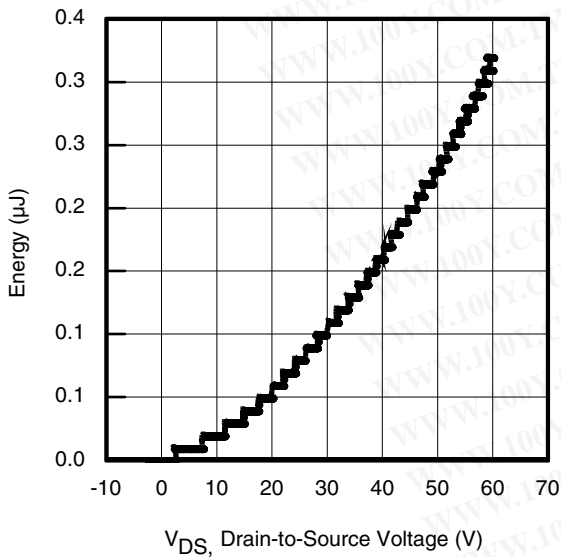


Fig 11. Typical  $C_{OSS}$  Stored Energy

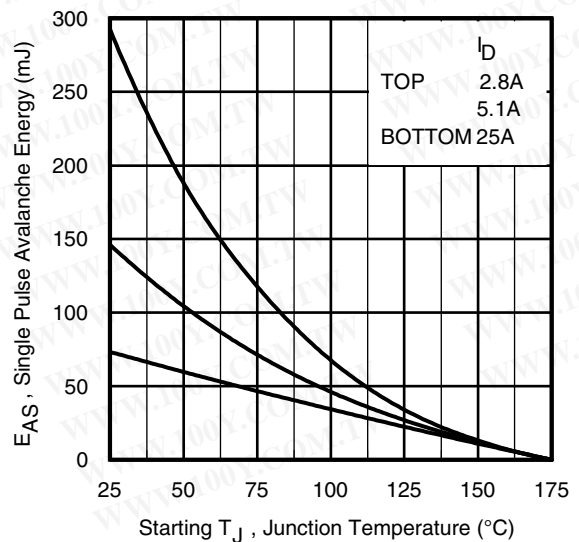


Fig 12. Maximum Avalanche Energy vs. Drain Current

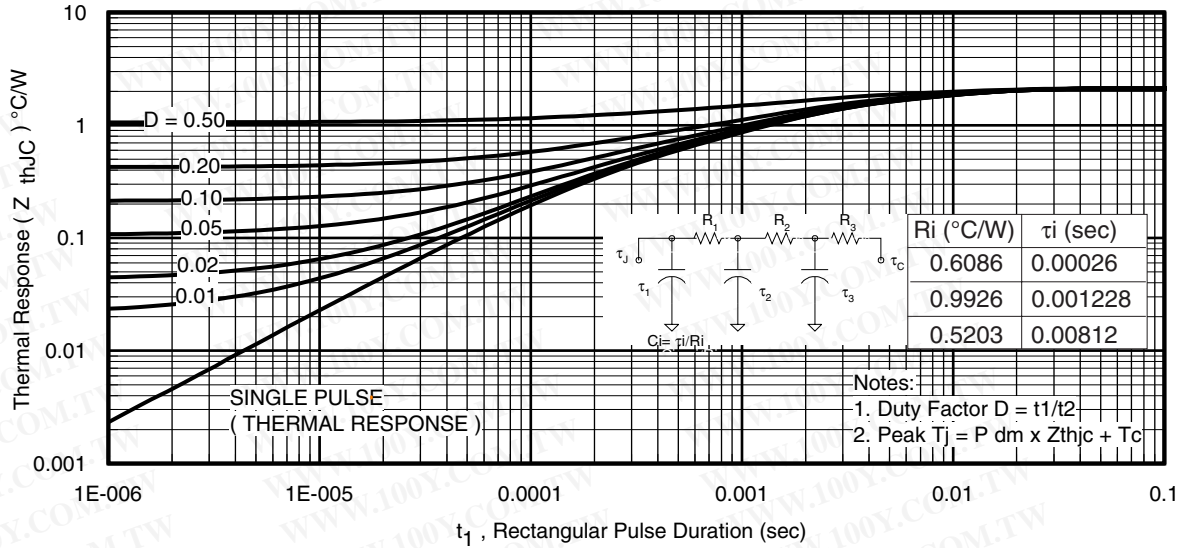


Fig 13. Maximum Effective Transient Thermal Impedance, Junction-to-Case

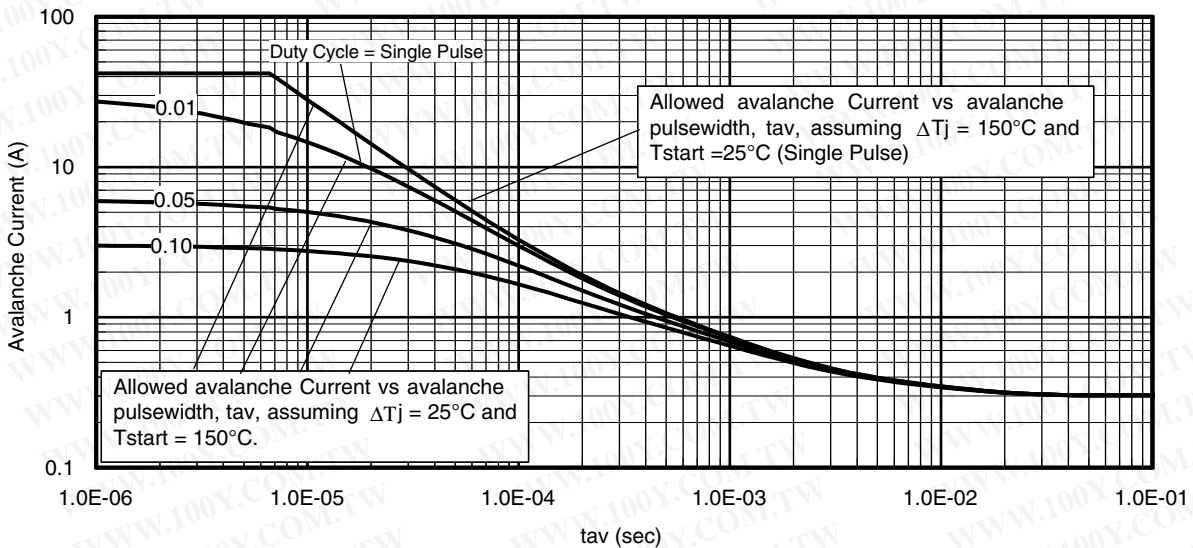
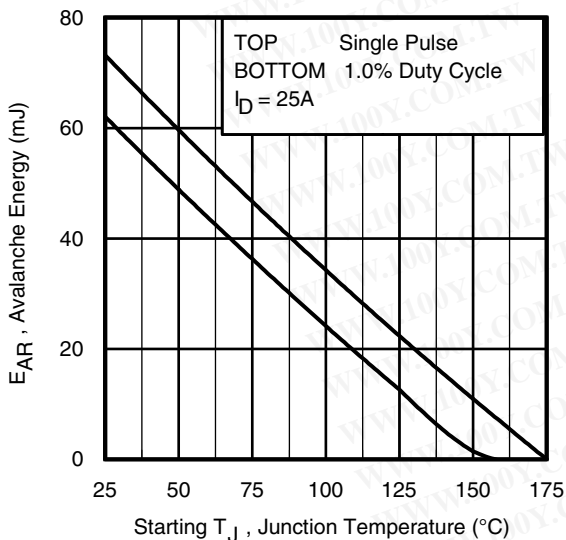


Fig 14. Typical Avalanche Current vs. Pulsewidth



**Notes on Repetitive Avalanche Curves , Figures 14, 15:**  
(For further info, see AN-1005 at [www.irf.com](http://www.irf.com))

1. Avalanche failures assumption:  
Purely a thermal phenomenon and failure occurs at a temperature far in excess of  $T_{jmax}$ . This is validated for every part type.
2. Safe operation in Avalanche is allowed as long as  $T_{jmax}$  is not exceeded.
3. Equation below based on circuit and waveforms shown in Figures 16a, 16b.
4.  $P_{D(ave)}$  = Average power dissipation per single avalanche pulse.
5. BV = Rated breakdown voltage (1.3 factor accounts for voltage increase during avalanche).
6.  $I_{av}$  = Allowable avalanche current.
7.  $\Delta T$  = Allowable rise in junction temperature, not to exceed  $T_{jmax}$  (assumed as 25°C in Figure 14, 15).  
 $t_{av}$  = Average time in avalanche.  
 $D$  = Duty cycle in avalanche =  $t_{av} \cdot f$   
 $Z_{thJC}(D, t_{av})$  = Transient thermal resistance, see Figures 13)

$$P_{D(ave)} = 1/2 ( 1.3 \cdot BV \cdot I_{av} ) = \Delta T / Z_{thJC}$$

$$I_{av} = 2\Delta T / [1.3 \cdot BV \cdot Z_{th}]$$

$$E_{AS(AR)} = P_{D(ave)} \cdot t_{av}$$

Fig 15. Maximum Avalanche Energy vs. Temperature

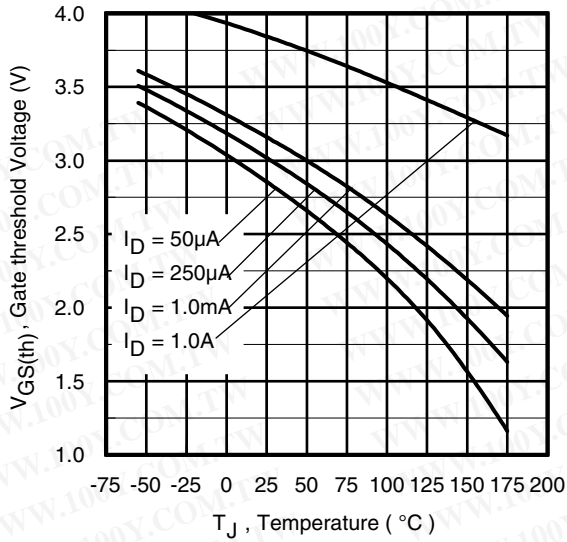


Fig 16. Threshold Voltage vs. Temperature

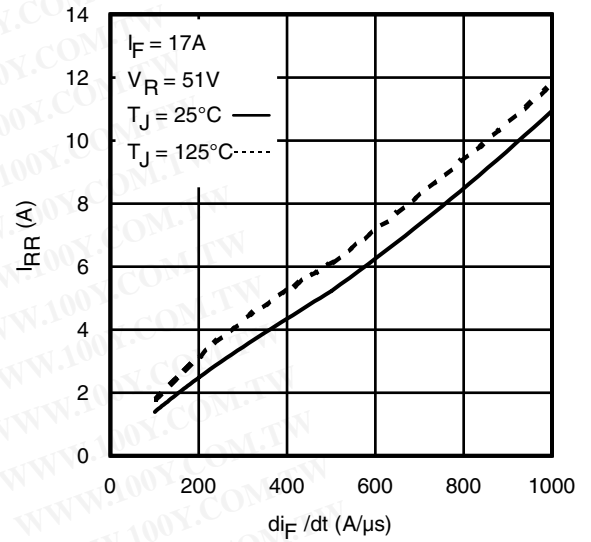


Fig. 17 - Typical Recovery Current vs.  $di_F/dt$

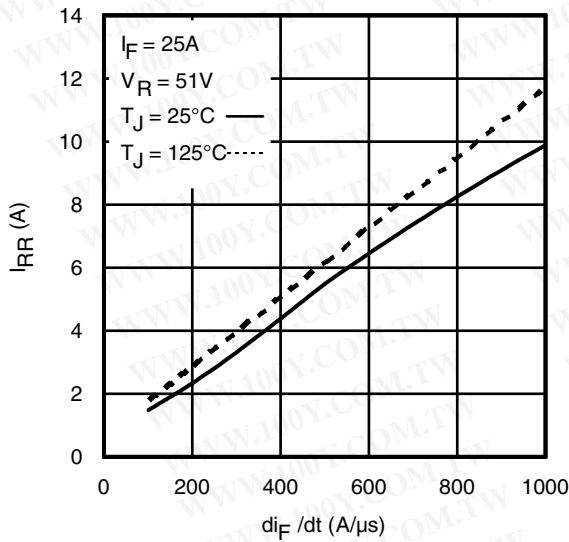


Fig. 18 - Typical Recovery Current vs.  $di_F/dt$

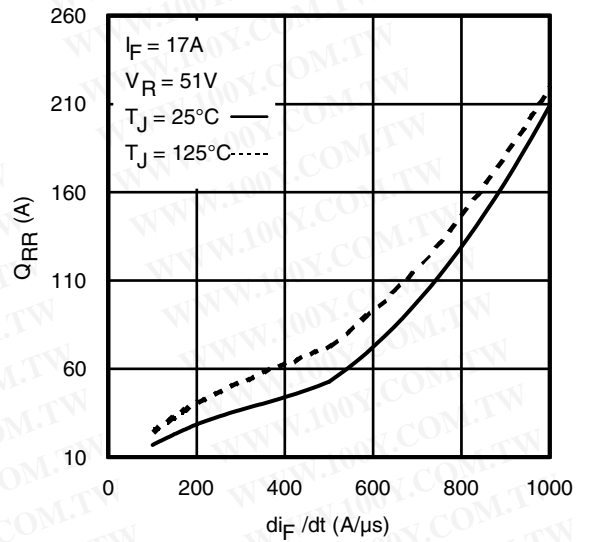


Fig. 19 - Typical Stored Charge vs.  $di_F/dt$

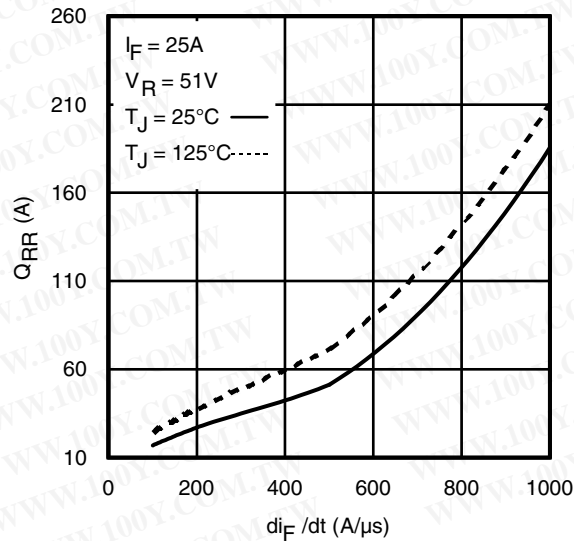
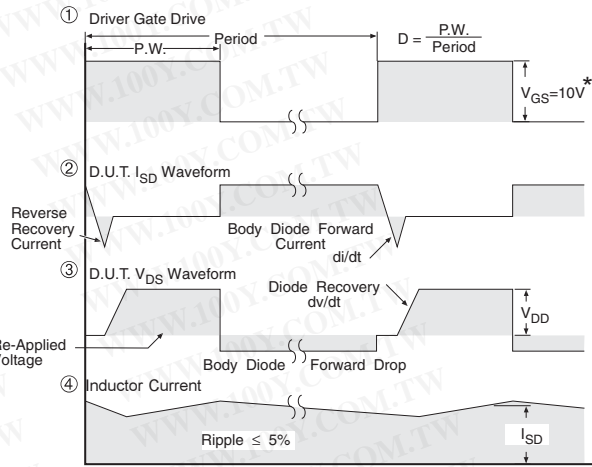
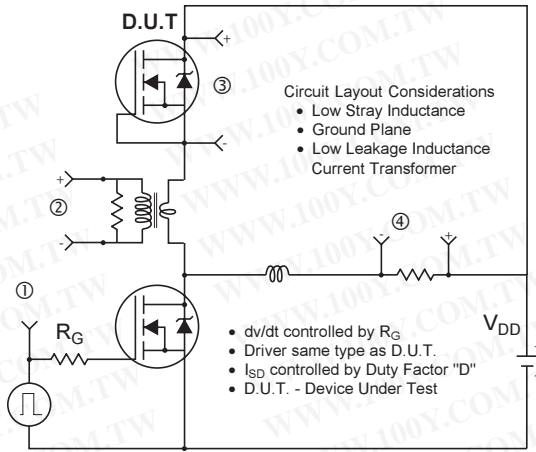
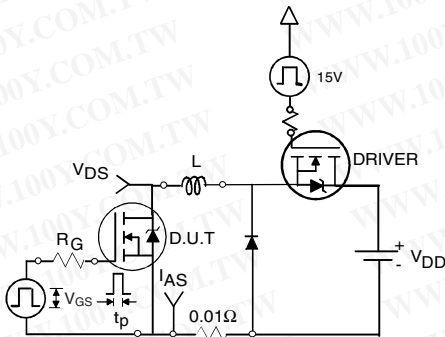


Fig. 20 - Typical Stored Charge vs.  $di_F/dt$

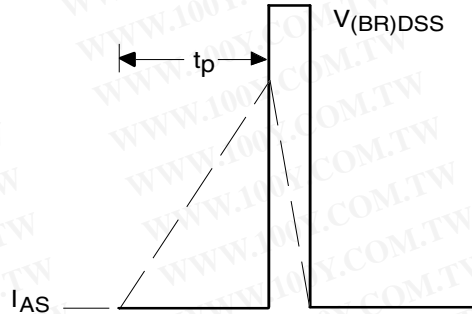


\*  $V_{GS} = 5V$  for Logic Level Devices

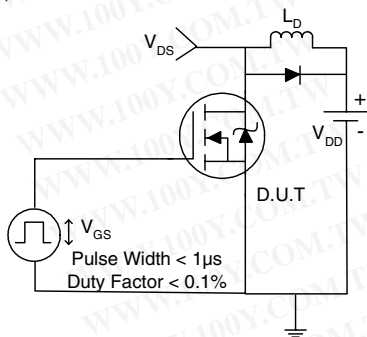
**Fig 20. Peak Diode Recovery  $dv/dt$  Test Circuit for N-Channel HEXFET<sup>®</sup> Power MOSFETs**



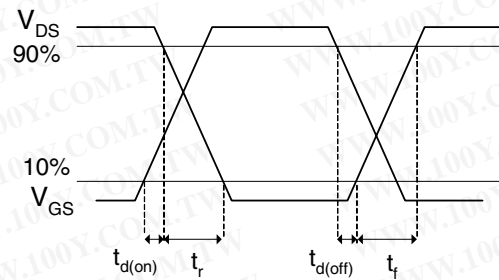
**Fig 21a. Unclamped Inductive Test Circuit**



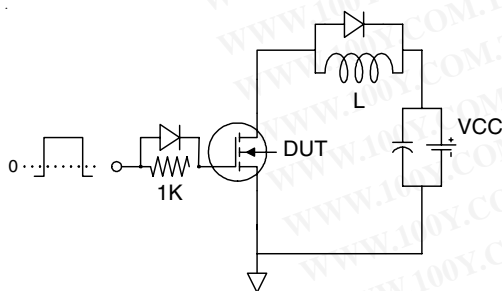
**Fig 21b. Unclamped Inductive Waveforms**



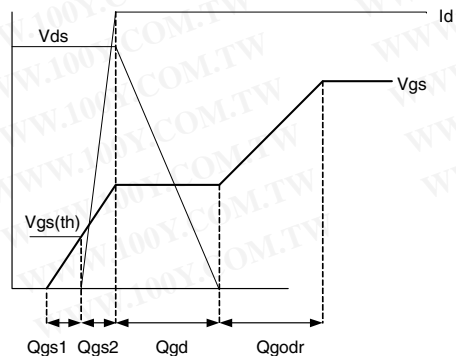
**Fig 22a. Switching Time Test Circuit**



**Fig 22b. Switching Time Waveforms**

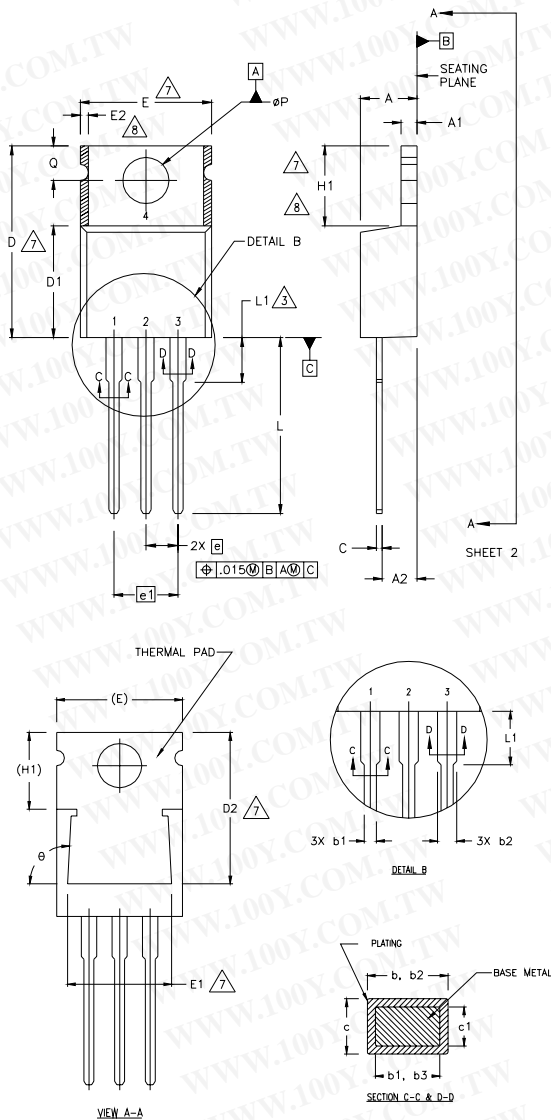


**Fig 23a. Gate Charge Test Circuit**



**Fig 23b. Gate Charge Waveform**

TO-220AB Package Outline (Dimensions are shown in millimeters (inches))



NOTES:

- 1 DIMENSIONING AND TOLERANCING PER ASME Y14.5 M- 1994.
- 2 DIMENSIONS ARE SHOWN IN INCHES [MILLIMETERS].
- 3 LEAD DIMENSION AND FINISH UNCONTROLLED IN L1.
- 4 DIMENSION D & E DO NOT INCLUDE MOLD FLASH. MOLD FLASH SHALL NOT EXCEED .005" (0.127) PER SIDE. THESE DIMENSIONS ARE MEASURED AT THE OUTERMOST EXTREMES OF THE PLASTIC BODY.
- 5 DIMENSION b1 & c1 APPLY TO BASE METAL ONLY.
- 6 CONTROLLING DIMENSION : INCHES.
- 7 THERMAL PAD CONTOUR OPTIONAL WITHIN DIMENSIONS E,H1,D2 & E1
- 8 DIMENSION E2 X H1 DEFINE A ZONE WHERE STAMPING AND SINGULATION IRREGULARITIES ARE ALLOWED.

LEAD ASSIGNMENTS

HEXFET

- 1.- GATE
- 2.- DRAIN
- 3.- SOURCE

IGBTs, CoPACK

- 1.- GATE
- 2.- COLLECTOR
- 3.- EMITTER

DIODES

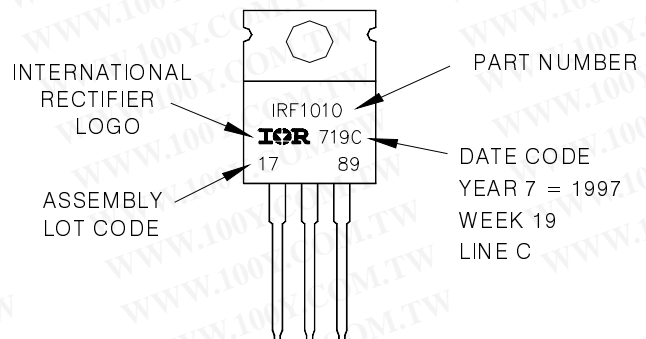
- 1.- ANODE/OPEN
- 2.- CATHODE
- 3.- ANODE

SYMBOL	DIMENSIONS				NOTES
	MILLIMETERS		INCHES		
	MIN.	MAX.	MIN.	MAX.	
A	3.56	4.82	.140	.190	
A1	0.51	1.40	.020	.055	
A2	2.04	2.92	.080	.115	
b	0.38	1.01	.015	.040	
b1	0.38	0.96	.015	.038	5
b2	1.15	1.77	.045	.070	
b3	1.15	1.73	.045	.068	
c	0.36	0.61	.014	.024	
c1	0.36	0.56	.014	.022	5
D	14.22	16.51	.560	.650	4
D1	8.38	9.02	.330	.355	
D2	12.19	12.88	.480	.507	7
E	9.66	10.66	.380	.420	4,7
E1	8.38	8.89	.330	.350	7
e	2.54 BSC		.100 BSC		
e1	5.08		.200 BSC		
H1	5.85	6.55	.230	.270	7,8
L	12.70	14.73	.500	.580	
L1	-	6.35	-	.250	3
φP	3.54	4.08	.139	.161	
Q	2.54	3.42	.100	.135	
φ	90°-93°		90°-93°		

TO-220AB Part Marking Information

EXAMPLE: THIS IS AN IRF1010  
 LOT CODE 1789  
 ASSEMBLED ON WW 19, 1997  
 IN THE ASSEMBLY LINE "C"

**Note:** "P" in assembly line position indicates "Lead-Free"



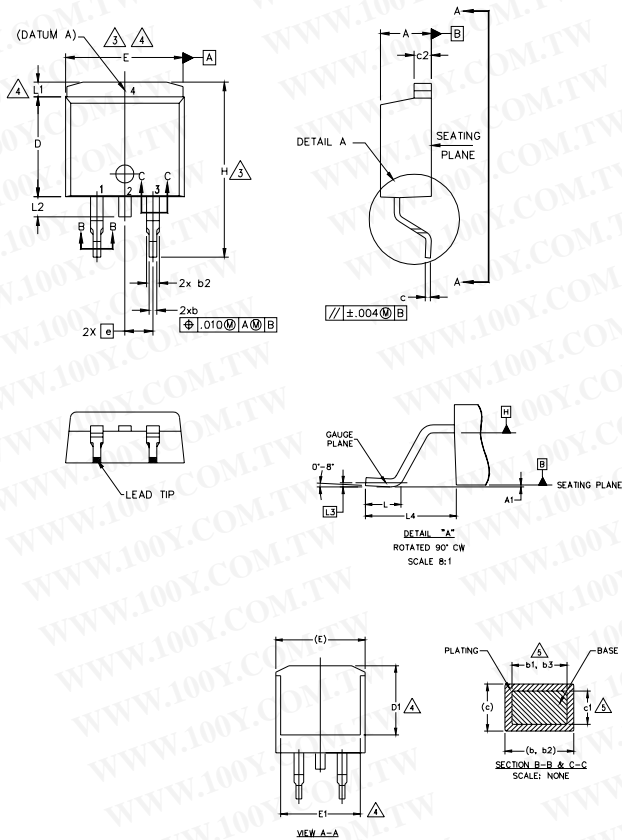
TO-220AB packages are not recommended for Surface Mount Application.

**Note:** For the most current drawing please refer to IR website at <http://www.irf.com/package/>



## D<sup>2</sup>Pak (TO-263AB) Package Outline

Dimensions are shown in millimeters (inches)



NOTES:

1. DIMENSIONING AND TOLERANCING PER ASME Y14.5M-1994
2. DIMENSIONS ARE SHOWN IN MILLIMETERS [INCHES].
3. DIMENSION D & E DO NOT INCLUDE MOLD FLASH. MOLD FLASH SHALL NOT EXCEED 0.127 [0.005"] PER SIDE. THESE DIMENSIONS ARE MEASURED AT THE OUTMOST EXTREMES OF THE PLASTIC BODY AT DATUM H.
4. THERMAL PAD CONTOUR OPTIONAL WITHIN DIMENSION E, L1, D1 & E1.
5. DIMENSION b1 AND c1 APPLY TO BASE METAL ONLY.
6. DATUM A & B TO BE DETERMINED AT DATUM PLANE H.
7. CONTROLLING DIMENSION: INCH.
8. OUTLINE CONFORMS TO JEDEC OUTLINE TO-263AB.

SYMBOL	DIMENSIONS				NOTES
	MILLIMETERS		INCHES		
	MIN.	MAX.	MIN.	MAX.	
A	4.06	4.83	.160	.190	
A1	0.00	0.254	.000	.010	
b	0.51	0.99	.020	.039	
b1	0.51	0.89	.020	.035	5
b2	1.14	1.78	.045	.070	
b3	1.14	1.73	.045	.068	5
c	0.38	0.74	.015	.029	
c1	0.38	0.58	.015	.023	5
c2	1.14	1.65	.045	.065	
D	8.38	9.65	.330	.380	3
D1	6.86	-	.270	-	4
E	9.65	10.67	.380	.420	3,4
E1	6.22	-	.245	-	4
e	2.54 BSC		.100 BSC		
H	14.61	15.88	.575	.625	
L	1.78	2.79	.070	.110	
L1	-	1.65	-	.066	4
L2	1.27	1.78	-	.070	
L3	0.25 BSC		.010 BSC		
L4	4.78	5.28	.188	.208	

LEAD ASSIGNMENTS

HEXFET

- 1.- GATE
- 2, 4.- DRAIN
- 3.- SOURCE

IGBTs, CoPACK

- 1.- GATE
- 2, 4.- COLLECTOR
- 3.- EMITTER

DIODES

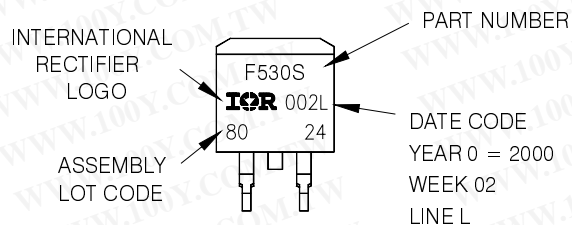
- 1.- ANODE \*
- 2, 4.- CATHODE
- 3.- ANODE

\* PART DEPENDENT.

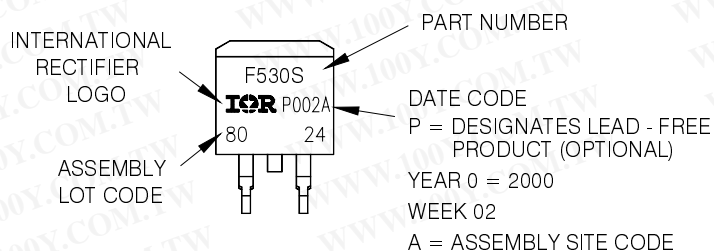
## D<sup>2</sup>Pak (TO-263AB) Part Marking Information

EXAMPLE: THIS IS AN IRF530S WITH  
LOT CODE 8024  
ASSEMBLED ON WW 02, 2000  
IN THE ASSEMBLY LINE "L"

Note: "P" in assembly line position  
indicates "Lead - Free"



OR

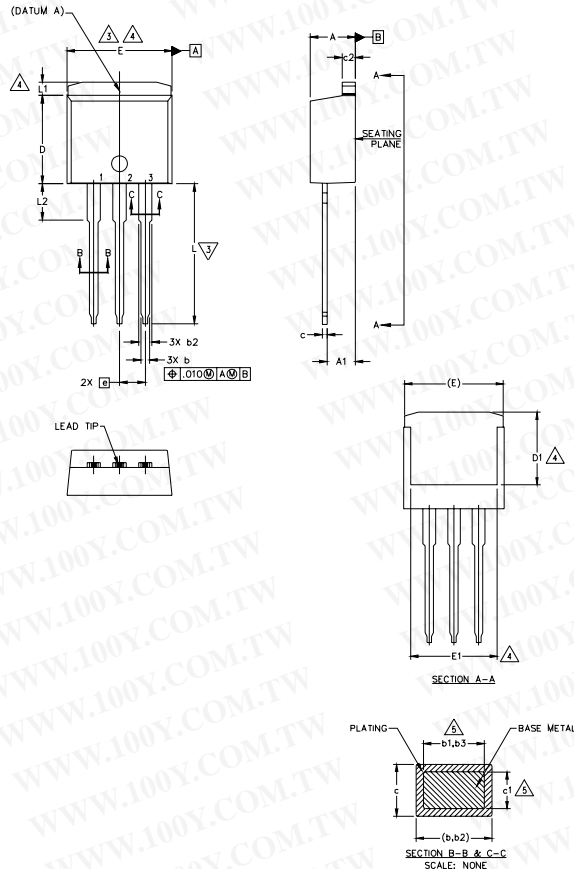


Note: For the most current drawing please refer to IR website at <http://www.irf.com/package/>

# IRFB/S/SL3806PbF

## TO-262 Package Outline

Dimensions are shown in millimeters (inches)



**NOTES:**

1. DIMENSIONING AND TOLERANCING PER ASME Y14.5M-1994
2. DIMENSIONS ARE SHOWN IN MILLIMETERS [INCHES].
3. DIMENSION D & E DO NOT INCLUDE MOLD FLASH. MOLD FLASH SHALL NOT EXCEED 0.127 [.005"] PER SIDE. THESE DIMENSIONS ARE MEASURED AT THE OUTMOST EXTREMES OF THE PLASTIC BODY.
4. THERMAL PAD CONTOUR OPTIONAL WITHIN DIMENSION E, L1, D1 & E1.
5. DIMENSION b1 AND c1 APPLY TO BASE METAL ONLY.
6. CONTROLLING DIMENSION: INCH.
7. OUTLINE CONFORM TO JEDEC TO-262 EXCEPT A1(max.), b(min.) AND D1(min.) WHERE DIMENSIONS DERIVED THE ACTUAL PACKAGE OUTLINE.

SYMBOL	DIMENSIONS				NOTES
	MILLIMETERS		INCHES		
	MIN.	MAX.	MIN.	MAX.	
A	4.06	4.83	.160	.190	
A1	2.03	3.02	.080	.119	
b	0.51	0.99	.020	.039	
b1	0.51	0.89	.020	.035	5
b2	1.14	1.78	.045	.070	
b3	1.14	1.73	.045	.068	5
c	0.38	0.74	.015	.029	
c1	0.38	0.58	.015	.023	5
c2	1.14	1.65	.045	.065	
D	8.38	9.65	.330	.380	3
D1	6.86	-	.270	-	4
E	9.65	10.67	.380	.420	3,4
E1	6.22	-	.245	-	4
e	2.54 BSC		.100 BSC		
L	13.46	14.10	.530	.555	
L1	-	1.65	-	.065	
L2	3.56	3.71	.140	.146	4

**LEAD ASSIGNMENTS**

**HEXFET**

- 1.- GATE
- 2.- DRAIN
- 3.- SOURCE
- 4.- DRAIN

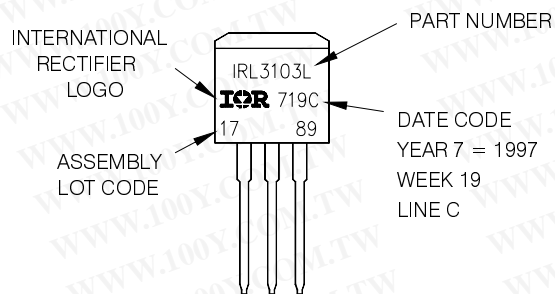
**IGBTs, CoPACK**

- 1.- GATE
- 2.- COLLECTOR
- 3.- EMITTER
- 4.- COLLECTOR

## TO-262 Part Marking Information

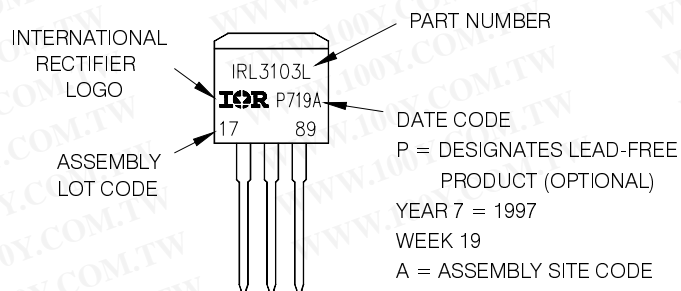
EXAMPLE: THIS IS AN IRL3103L  
 LOT CODE 1789  
 ASSEMBLED ON WW 19, 1997  
 IN THE ASSEMBLY LINE "C"

Note: "P" in assembly line position indicates "Lead - Free"



PART NUMBER  
 DATE CODE  
 YEAR 7 = 1997  
 WEEK 19  
 LINE C

OR



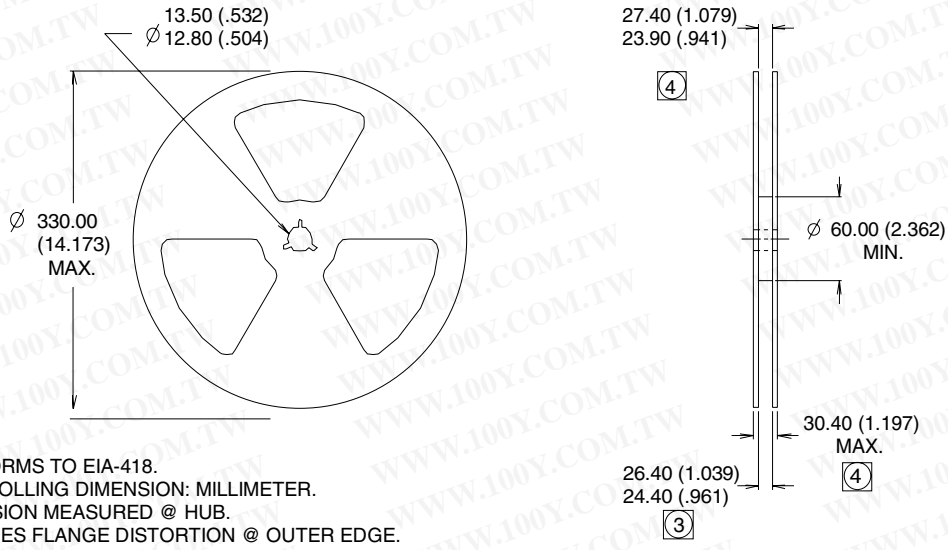
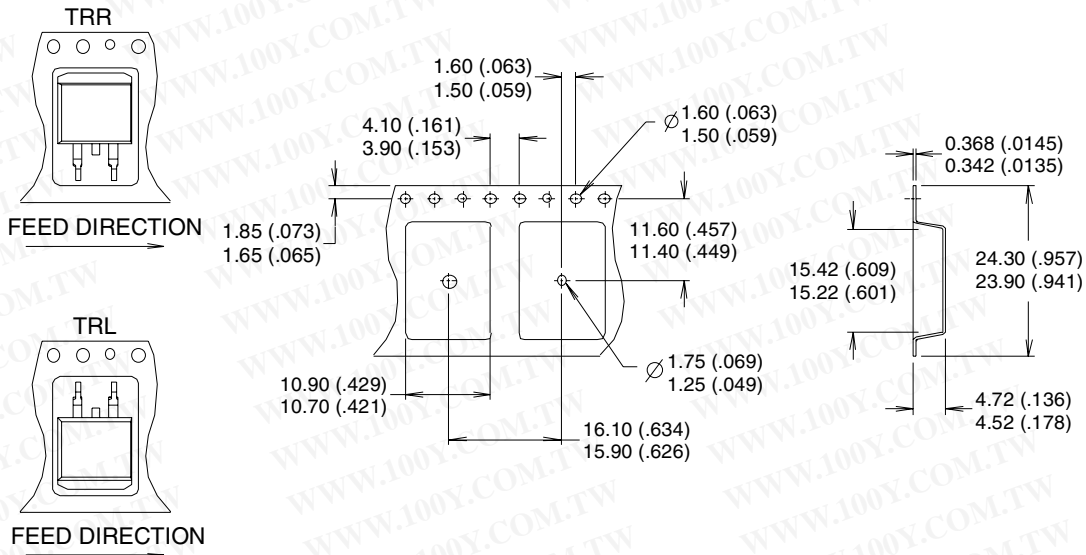
PART NUMBER  
 DATE CODE  
 P = DESIGNATES LEAD-FREE PRODUCT (OPTIONAL)  
 YEAR 7 = 1997  
 WEEK 19  
 A = ASSEMBLY SITE CODE

Note: For the most current drawing please refer to IR website at <http://www.irf.com/package/>

D<sup>2</sup>Pak (TO-263AB) Tape & Reel Information

Dimensions are shown in millimeters (inches)

勝特力材料 886-3-5753170  
 勝特力电子(上海) 86-21-34970699  
 勝特力电子(深圳) 86-755-83298787  
 Http://www.100y.com.tw



- NOTES :
1. CONFORMS TO EIA-418.
  2. CONTROLLING DIMENSION: MILLIMETER.
  - ③ DIMENSION MEASURED @ HUB.
  - ④ INCLUDES FLANGE DISTORTION @ OUTER EDGE.

Note: For the most current drawing please refer to IR website at <http://www.irf.com/package/>

Data and specifications subject to change without notice.  
 This product has been designed and qualified for the Industrial market.  
 Qualification Standards can be found on IR's Web site.