

International **IR** Rectifier

IRG4IBC30KDPbF

INSULATED GATE BIPOLAR TRANSISTOR WITH
 ULTRAFAST SOFT RECOVERY DIODE

Short Circuit Rated
 UltraFast IGBT

Features

- High switching speed optimized for up to 25kHz with low $V_{CE(on)}$
- Short Circuit Rating 10 μ s @ 125°C, $V_{GE} = 15V$
- Generation 4 IGBT design provides tighter parameter distribution and higher efficiency than previous generation
- IGBT co-packaged with HEXFRED™ ultrafast, ultra-soft-recovery anti-parallel diodes for use in bridge configurations
- Industry standard TO-220 FULLPAK
- Lead-Free

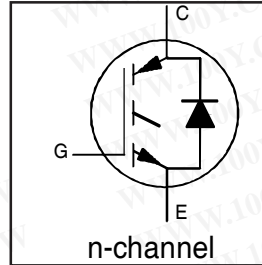

$V_{CES} = 600V$
 $V_{CE(on)} \text{ typ.} = 2.21V$
 @ $V_{GE} = 15V, I_C = 9.2A$

Benefits

- Generation 4 IGBTs offer highest efficiencies available maximizing the power density of the system
- IGBT's optimized for specific application conditions
- HEXFRED™ diodes optimized for performance with IGBTs. Minimized recovery characteristics reduce noise EMI
- Designed to exceed the power handling capability of equivalent industry-standard IGBT

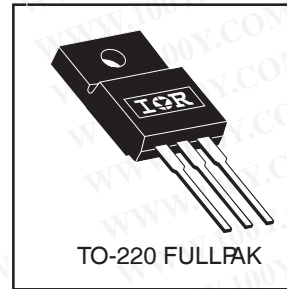

Absolute Maximum Ratings

	Parameter	Max.	Units
V_{CES}	Collector-to-Emitter Voltage	600	V
$I_C @ T_C = 25^\circ C$	Continuous Collector Current	17	A
$I_C @ T_C = 100^\circ C$	Continuous Collector Current	9.2	
I_{CM}	Pulsed Collector Current ①⑤	34	
I_{LM}	Clamped Inductive Load Current ②③	34	
$I_F @ T_C = 100^\circ C$	Diode Continuous Forward Current	9.2	
I_{FM}	Diode Maximum Forward Current	34	
t_{sc}	Short Circuit Withstand Time	10	μ s
V_{ISOL}	RMS Isolation Voltage, Terminal to Case, t = 1 min	2500	V
V_{GE}	Gate-to-Emitter Voltage	± 20	W
$P_D @ T_C = 25^\circ C$	Maximum Power Dissipation	45	
$P_D @ T_C = 100^\circ C$	Maximum Power Dissipation	18	
T_J T_{STG}	Operating Junction and Storage Temperature Range	-55 to +150	
	Soldering Temperature, for 10 sec.	300 (0.063 in. (1.6mm) from case)	
	Mounting Torque, 6-32 or M3 Screw.	10 lbf·in (1.1 N·m)	

Thermal Resistance

	Parameter	Typ.	Max.	Units
$R_{\theta JC}$	Junction-to-Case - IGBT	---	2.8	$^\circ C/W$
$R_{\theta CS}$	Junction-to-Case - Diode	---	3.7	
$R_{\theta JA}$	Junction-to-Ambient, typical socket mount	---	65	
Wt	Weight	2.0 (0.07)	---	g (oz)

IRG4IBC30KDPbF

International
IR Rectifier

Electrical Characteristics @ T_J = 25°C (unless otherwise specified)

	Parameter	Min.	Typ.	Max.	Units	Conditions
V _{(BR)CES}	Collector-to-Emitter Breakdown Voltage ^③	600	—	—	V	V _{GE} = 0V, I _C = 250μA
ΔV _{(BR)CES} /ΔT _J	Temperature Coeff. of Breakdown Voltage	—	0.54	—	V/°C	V _{GE} = 0V, I _C = 1.0mA
V _{CE(on)}	Collector-to-Emitter Saturation Voltage	—	2.21	2.7	V	I _C = 16A V _{GE} = 15V
		—	2.88	—		I _C = 28A See Fig. 2, 5
		—	2.36	—		I _C = 16A, T _J = 150°C
V _{GE(th)}	Gate Threshold Voltage	3.0	—	6.0		V _{CE} = V _{GE} , I _C = 250μA
ΔV _{GE(th)} /ΔT _J	Temperature Coeff. of Threshold Voltage	—	-12	—	mV/°C	V _{CE} = V _{GE} , I _C = 250μA
g _{fe}	Forward Transconductance ^④	5.4	8.1	—	S	V _{CE} = 100V, I _C = 16A
I _{CES}	Zero Gate Voltage Collector Current	—	—	250	μA	V _{GE} = 0V, V _{CE} = 600V
		—	—	2500		V _{GE} = 0V, V _{CE} = 600V, T _J = 150°C
V _{FM}	Diode Forward Voltage Drop	—	1.4	1.7	V	I _C = 12A See Fig. 13
		—	1.3	1.6		I _C = 12A, T _J = 150°C
I _{GES}	Gate-to-Emitter Leakage Current	—	—	±100	nA	V _{GE} = ±20V

Switching Characteristics @ T_J = 25°C (unless otherwise specified)

	Parameter	Min.	Typ.	Max.	Units	Conditions
Q _g	Total Gate Charge (turn-on)	—	67	100		I _C = 16A
Q _{ge}	Gate - Emitter Charge (turn-on)	—	11	16	nC	V _{CC} = 400V See Fig.8
Q _{gc}	Gate - Collector Charge (turn-on)	—	25	37		V _{GE} = 15V
t _{d(on)}	Turn-On Delay Time	—	60	—	ns	T _J = 25°C
t _r	Rise Time	—	42	—		I _C = 16A, V _{CC} = 480V
t _{d(off)}	Turn-Off Delay Time	—	160	250		V _{GE} = 15V, R _G = 23Ω
t _f	Fall Time	—	80	120		Energy losses include "tail" and diode reverse recovery See Fig. 9,10,14
E _{on}	Turn-On Switching Loss	—	0.60	—	mJ	V _{CC} = 360V, T _J = 125°C V _{GE} = 15V, R _G = 10Ω, V _{CPK} < 500V
E _{off}	Turn-Off Switching Loss	—	0.58	—		
E _{ts}	Total Switching Loss	—	1.18	1.6		
t _{sc}	Short Circuit Withstand Time	10	—	—	μs	
t _{d(on)}	Turn-On Delay Time	—	58	—	ns	T _J = 150°C, See Fig. 10,11,18
t _r	Rise Time	—	42	—		I _C = 16A, V _{CC} = 480V
t _{d(off)}	Turn-Off Delay Time	—	210	—		V _{GE} = 15V, R _G = 23Ω
t _f	Fall Time	—	160	—		Energy losses include "tail" and diode reverse recovery
E _{ts}	Total Switching Loss	—	1.69	—	mJ	
L _E	Internal Emitter Inductance	—	7.5	—	nH	Measured 5mm from package
C _{ies}	Input Capacitance	—	920	—	pF	V _{GE} = 0V
C _{oes}	Output Capacitance	—	110	—		V _{CC} = 30V See Fig. 7
C _{res}	Reverse Transfer Capacitance	—	27	—		f = 1.0MHz
t _{rr}	Diode Reverse Recovery Time	—	42	60	ns	T _J = 25°C See Fig. 14
		—	80	120		T _J = 125°C
I _{rr}	Diode Peak Reverse Recovery Current	—	3.5	6.0	A	T _J = 25°C See Fig. 15
		—	5.6	10		T _J = 125°C
Q _{rr}	Diode Reverse Recovery Charge	—	80	180	nC	T _J = 25°C See Fig. 16
		—	220	600		T _J = 125°C
di _(rec) /dt	Diode Peak Rate of Fall of Recovery During t _b	—	180	—	A/μs	T _J = 25°C See Fig. 17
		—	160	—		T _J = 125°C

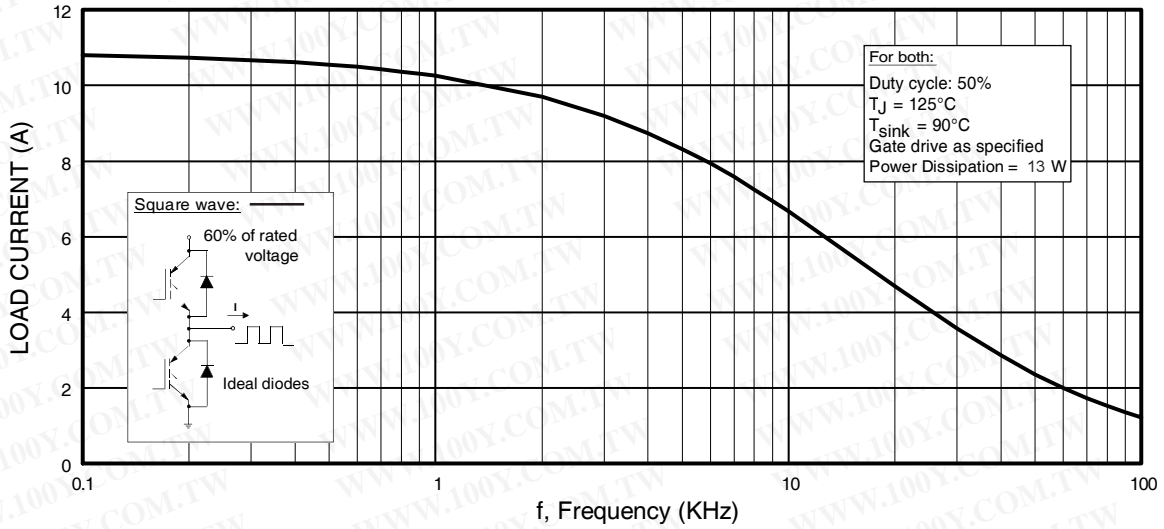

Fig. 1 - Typical Load Current vs. Frequency
 (Load Current = I_{RMS} of fundamental)

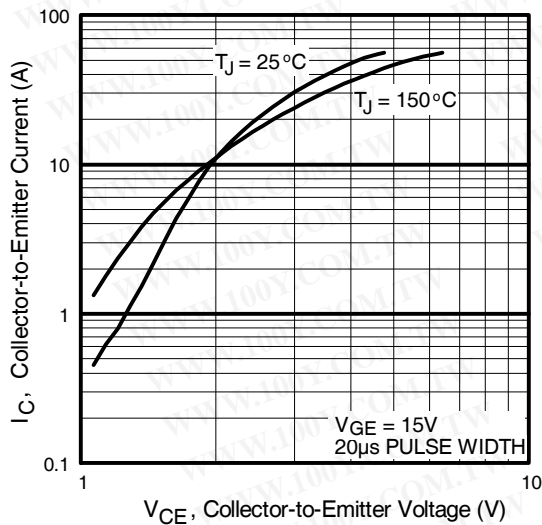

Fig. 2 - Typical Output Characteristics

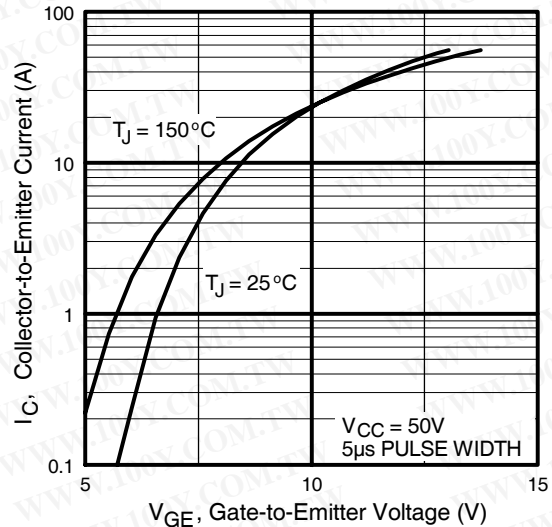

Fig. 3 - Typical Transfer Characteristics

IRG4IBC30KDPbF

International
IRF Rectifier

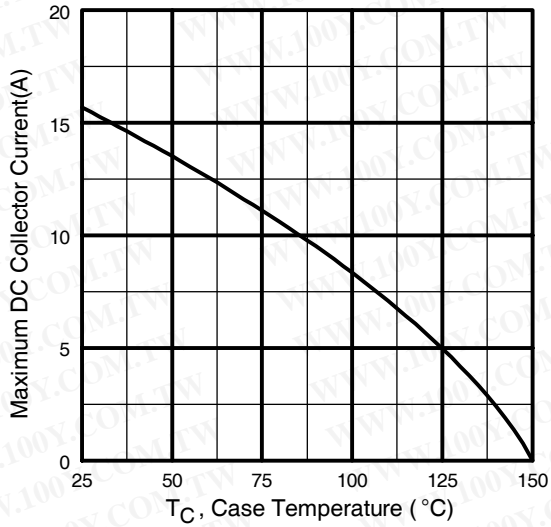

Fig. 4 - Maximum Collector Current vs. Case Temperature

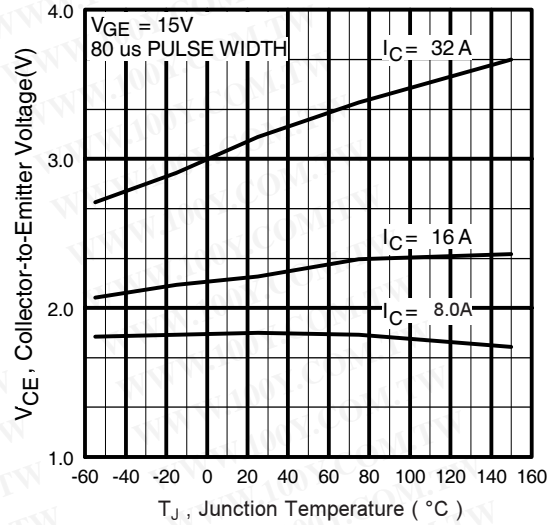

Fig. 5 - Typical Collector-to-Emitter Voltage vs. Junction Temperature

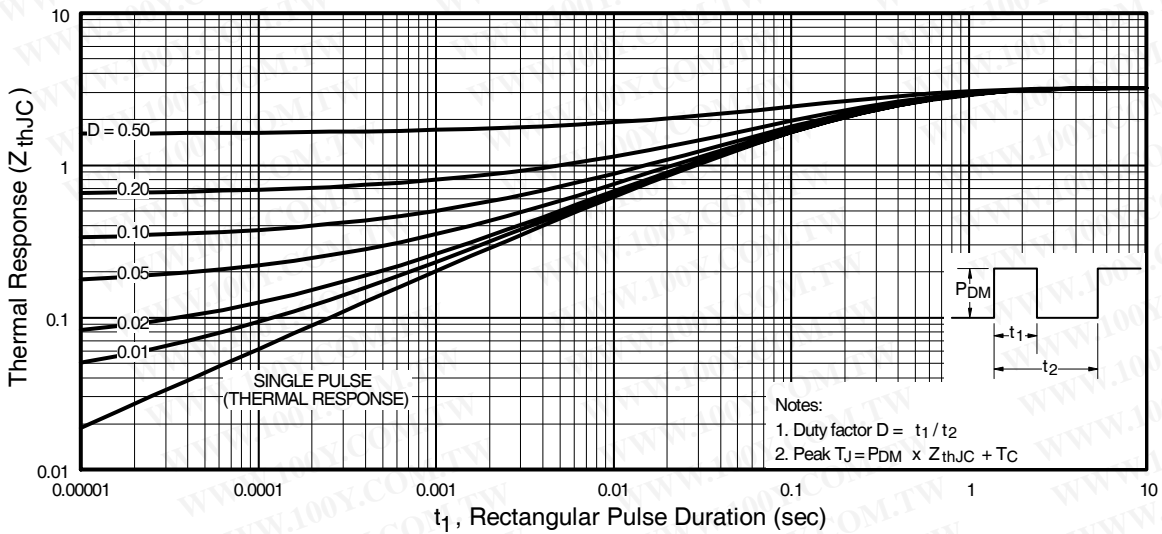

Fig. 6 - Maximum Effective Transient Thermal Impedance, Junction-to-Case

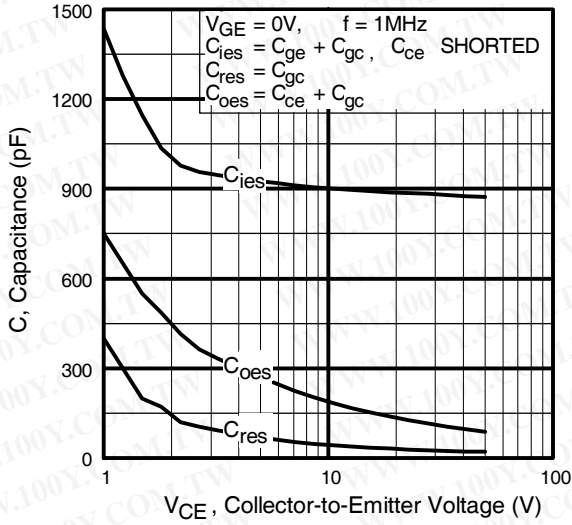

Fig. 7 - Typical Capacitance vs. Collector-to-Emitter Voltage

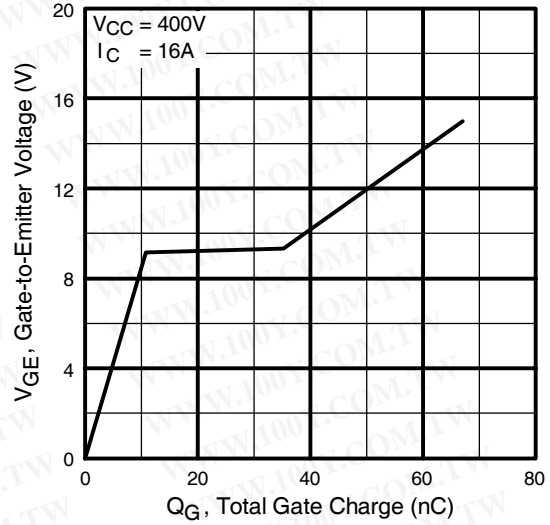

Fig. 8 - Typical Gate Charge vs. Gate-to-Emitter Voltage

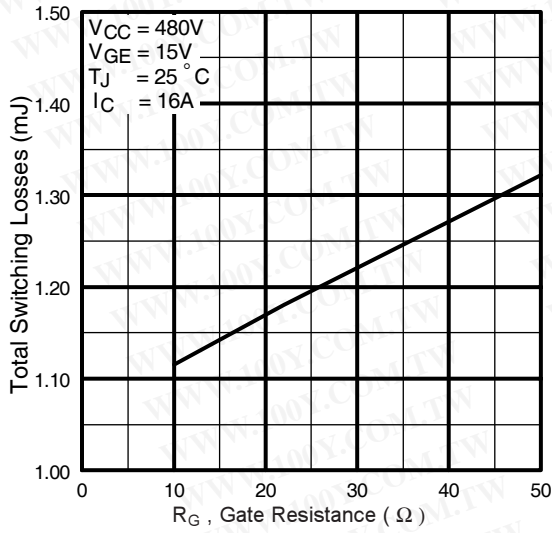

Fig. 9 - Typical Switching Losses vs. Gate Resistance

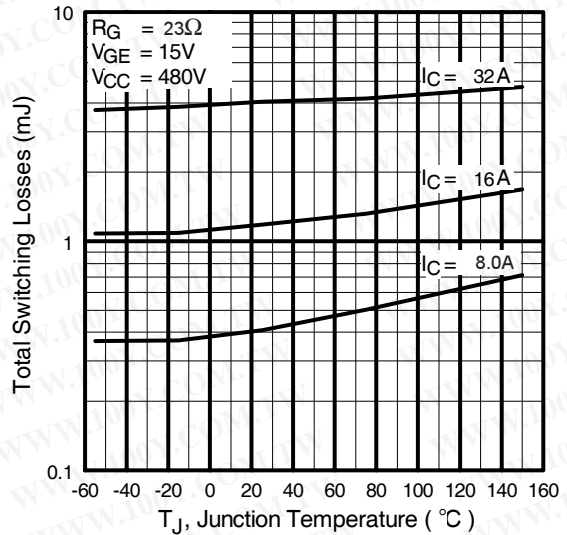

Fig. 10 - Typical Switching Losses vs. Junction Temperature

IRG4IBC30KDPbF

International
IR Rectifier

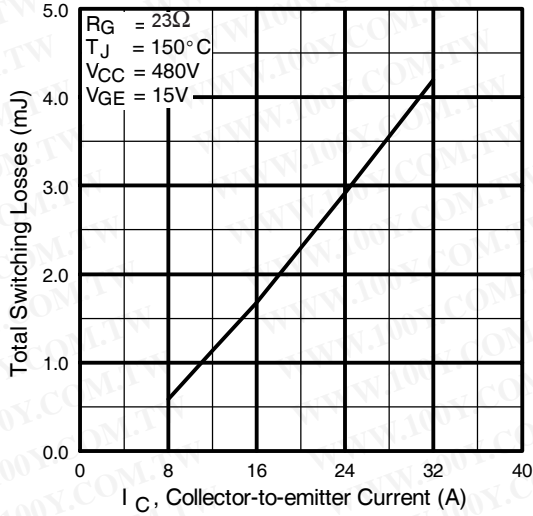

Fig. 11 - Typical Switching Losses vs. Collector-to-Emitter Current

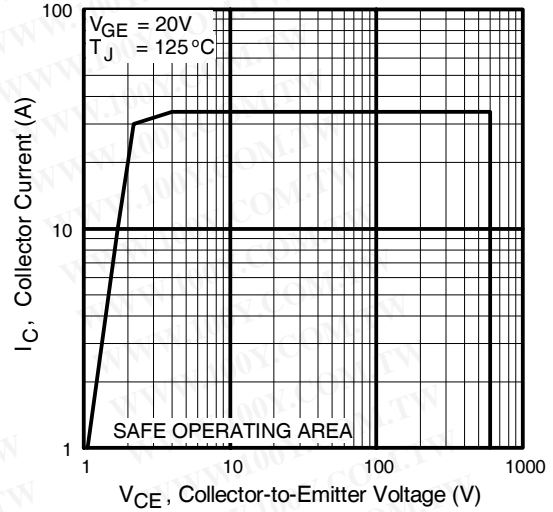

Fig. 12 - Turn-Off SOA

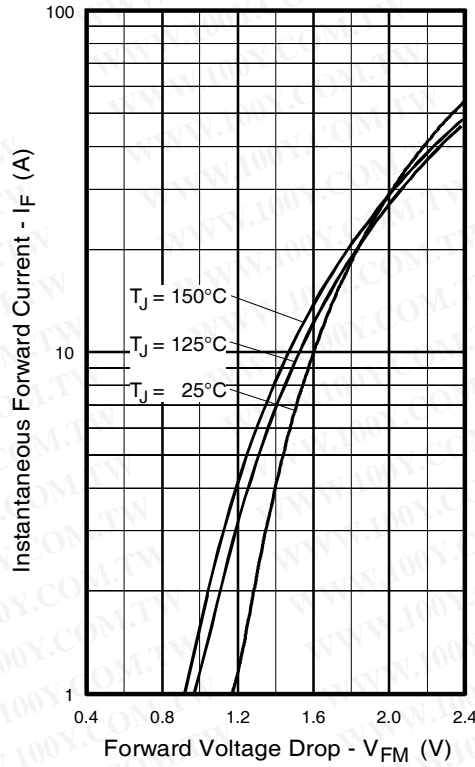

Fig. 13 - Maximum Forward Voltage Drop vs. Instantaneous Forward Current

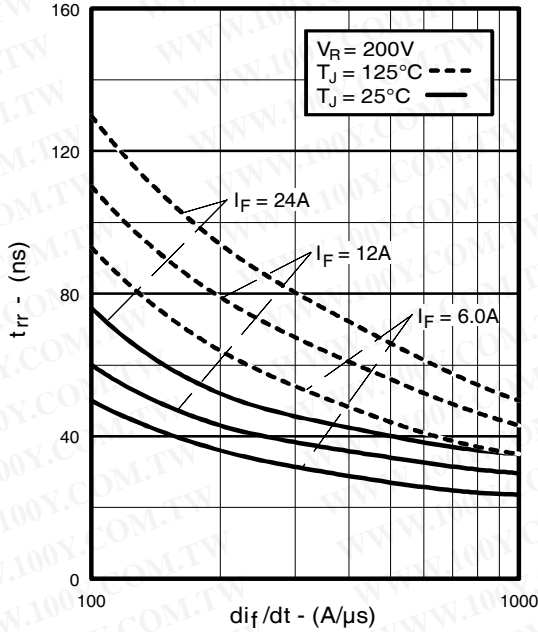

Fig. 14 - Typical Reverse Recovery vs. di_f/dt

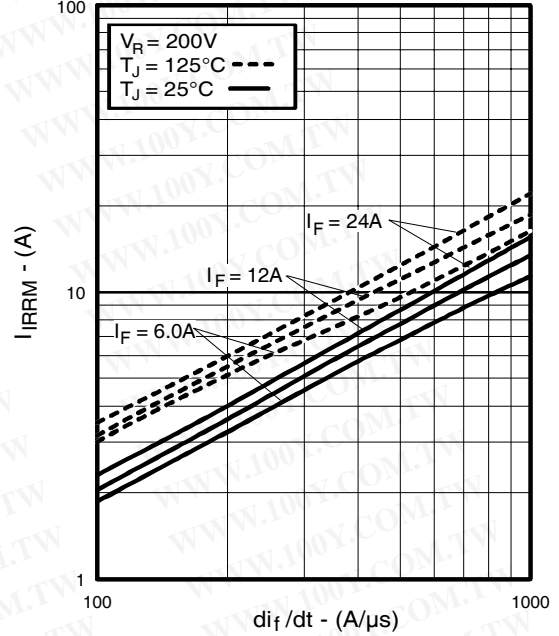

Fig. 15 - Typical Recovery Current vs. di_f/dt

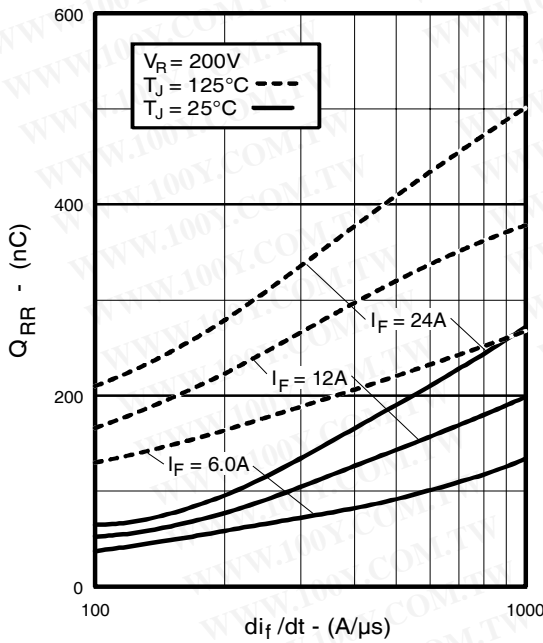

Fig. 16 - Typical Stored Charge vs. di_f/dt

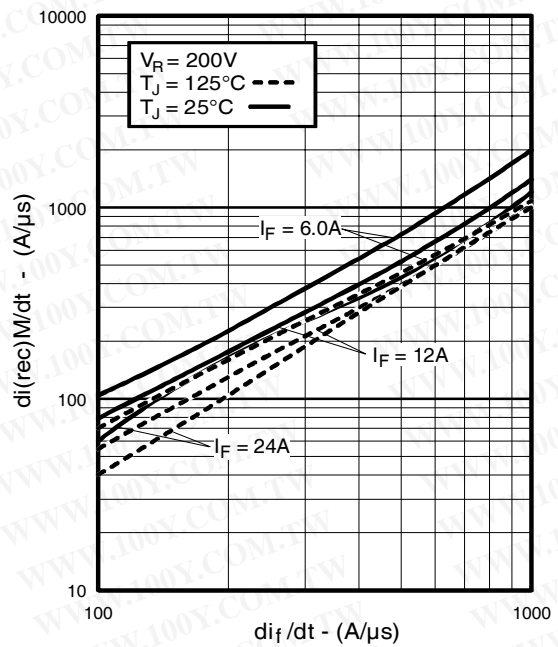

Fig. 17 - Typical $di_{(rec)M}/dt$ vs. di_f/dt

IRG4IBC30KDPbF

International
IRF Rectifier

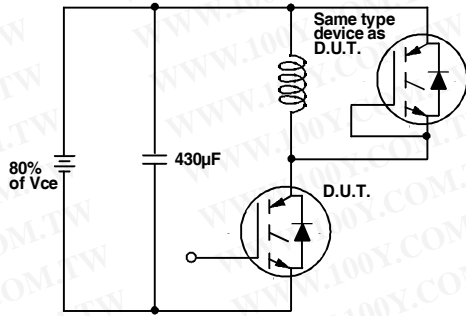

Fig. 18a - Test Circuit for Measurement of I_{LM} , E_{on} , $E_{off}(\text{diode})$, t_{rr} , Q_{rr} , I_{rr} , $t_{d(on)}$, t_r , $t_{d(off)}$, t_f

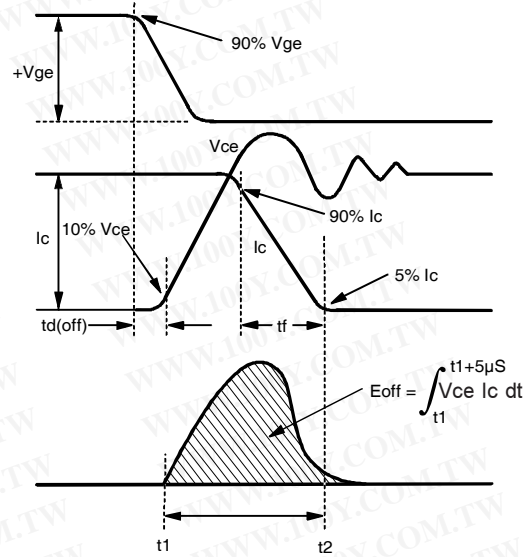

Fig. 18b - Test Waveforms for Circuit of Fig. 18a, Defining E_{off} , $t_{d(off)}$, t_f

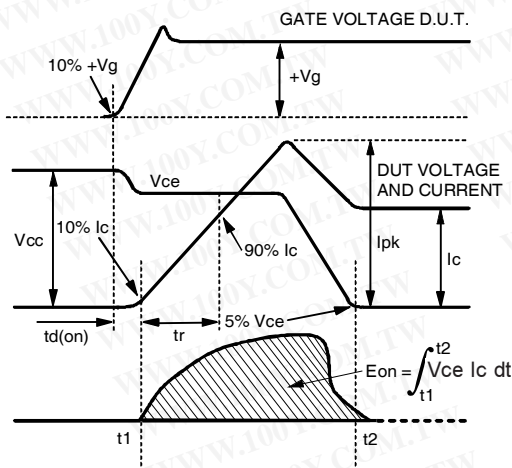

Fig. 18c - Test Waveforms for Circuit of Fig. 18a, Defining E_{on} , $t_{d(on)}$, t_r

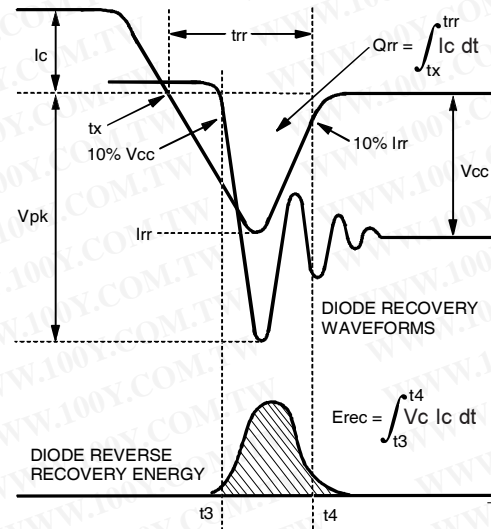

Fig. 18d - Test Waveforms for Circuit of Fig. 18a, Defining E_{rec} , t_{rr} , Q_{rr} , I_{rr}

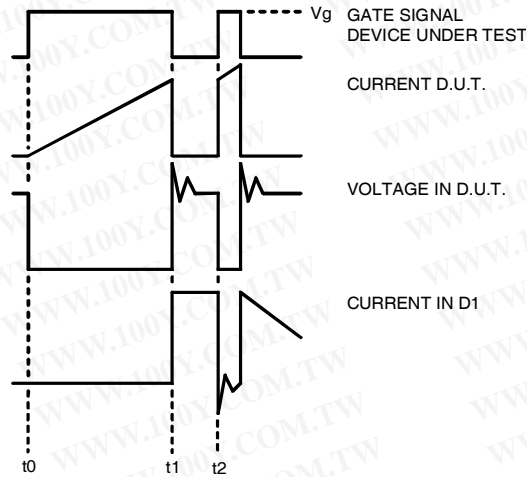

Figure 18e. Macro Waveforms for Figure 18a's Test Circuit

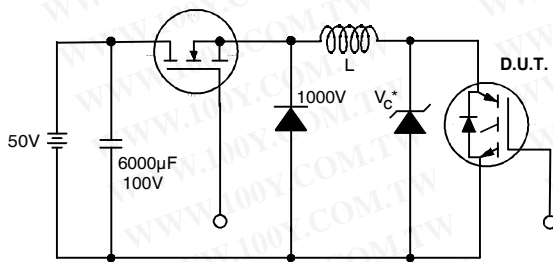

Figure 19. Clamped Inductive Load Test Circuit

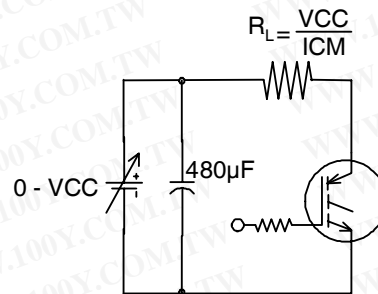

Figure 20. Pulsed Collector Current Test Circuit

勝特力材料 886-3-5753170
 勝特力电子(上海) 86-21-34970699
 勝特力电子(深圳) 86-755-83298787
 Http://www.100y.com.tw

IRG4IBC30KDPbF

TO-220AB Full-Pak Package Outline

International
IR Rectifier

Dimensions are shown in millimeters (inches)

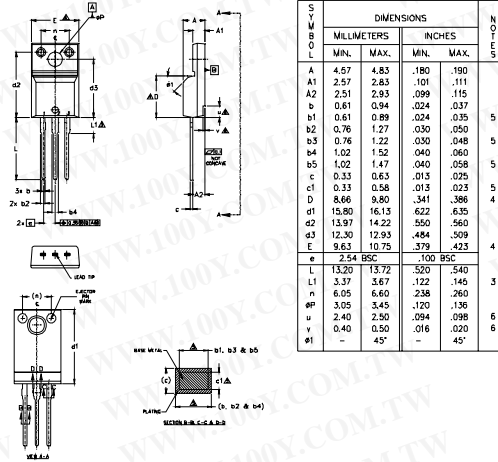

TO-220AB Full-Pak Part Marking Information

EXAMPLE: THIS IS AN IRF1840G
 WITH ASSEMBLY
 LOT CODE 3432
 ASSEMBLED ON WW 24, 2001
 IN THE ASSEMBLY LINE 'K'

Note: 'P' in assembly line position
 indicates 'Lead-Free'

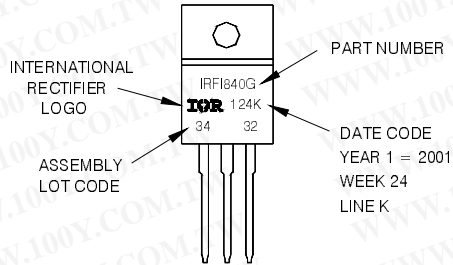

TO-220AB Full-Pak package is not recommended for Surface Mount Application.

Notes:

- ① Repetitive rating: $V_{GE}=20V$; pulse width limited by maximum junction temperature (figure 20).
- ② $V_{CC}=80\%(V_{CES})$, $V_{GE}=20V$, $L=10\mu H$, $R_G=23\Omega$ (figure 19).
- ③ Pulse width $\leq 80\mu s$; duty factor $\leq 0.1\%$.
- ④ Pulse width $5.0\mu s$, single shot.
- ⑤ Uses IRG4IBC30KD data and test conditions.

Note: For the most current drawing please refer to IR website at <http://www.irf.com/package/>

Data and specifications subject to change without notice.

International
IR Rectifier

IR WORLD HEADQUARTERS: 233 Kansas St., El Segundo, California 90245, USA Tel: (310) 252-7105
 TAC Fax: (310) 252-7903

Visit us at www.irf.com for sales contact information.06/2010