

International
IR Rectifier

PD-95913

IRGPS60B120KDP

INSULATED GATE BIPOLAR TRANSISTOR WITH
 ULTRAFAST SOFT RECOVERY DIODE

Motor Control Co-Pack IGBT

Features

- Low VCE (on) Non Punch Through IGBT Technology.
- Low Diode VF.
- 10µs Short Circuit Capability.
- Square RBSOA.
- Ultrasoft Diode Reverse Recovery Characteristics.
- Positive VCE (on) Temperature Coefficient.
- Super-247 Package.
- Lead-Free

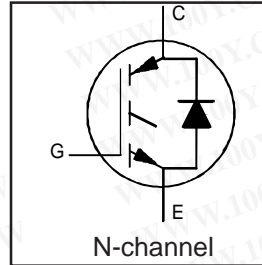

$V_{CES} = 1200V$
 $V_{CE(on)} \text{ typ.} = 2.50V$
 @ $V_{GE} = 15V,$
 $I_{CE} = 60A, T_j = 25^\circ C$

Benefits

- Benchmark Efficiency for Motor Control.
- Rugged Transient Performance.
- Low EMI.
- Significantly Less Snubber Required
- Excellent Current Sharing in Parallel Operation.



Absolute Maximum Ratings

	Parameter	Max.	Units
V_{CES}	Collector-to-Emitter Voltage	1200	V
$I_C @ T_C = 25^\circ C$	Continuous Collector Current	105②	A
$I_C @ T_C = 100^\circ C$	Continuous Collector Current	60	
I_{CM}	Pulsed Collector Current	240	
I_{LM}	Clamped Inductive Load Current ①	240	
$I_F @ T_C = 25^\circ C$	Diode Continuous Forward Current	120	
$I_F @ T_C = 100^\circ C$	Diode Continuous Forward Current	60	
I_{FM}	Diode Maximum Forward Current	240	
V_{GE}	Gate-to-Emitter Voltage	± 20	V
$P_D @ T_C = 25^\circ C$	Maximum Power Dissipation	595	W
$P_D @ T_C = 100^\circ C$	Maximum Power Dissipation	238	
T_J	Operating Junction and	-55 to +150	$^\circ C$
T_{STG}	Storage Temperature Range		
	Soldering Temperature, for 10 sec.	300 (0.063 in. (1.6mm) from case)	

Thermal Resistance

	Parameter	Min.	Typ.	Max.	Units
$R_{\theta JC}$	Junction-to-Case - IGBT	—	—	0.20	$^\circ C/W$
$R_{\theta JC}$	Junction-to-Case - Diode	—	—	0.41	
$R_{\theta CS}$	Case-to-Sink, flat, greased surface	—	0.24	—	
$R_{\theta JA}$	Junction-to-Ambient, typical socket mount	—	—	40	
	Recommended Clip Force	20 (2)	—	—	N(kgf)
Wt	Weight	—	6.0 (0.21)	—	g (oz)
Le	Internal Emitter Inductance (5mm from package)	—	13	—	nH

IRGPS60B120KDP

International
IR Rectifier

Electrical Characteristics @ T_J = 25°C (unless otherwise specified)

	Parameter	Min.	Typ.	Max.	Units	Conditions	Ref.Fig.
V _{(BR)CES}	Collector-to-Emitter Breakdown Voltage	1200	—	—	V	V _{GE} = 0V, I _C = 500μA	
ΔV _{(BR)CES} /ΔT _J	Temperature Coeff. of Breakdown Voltage	—	0.40	—	V/°C	V _{GE} = 0V, I _C = 1.0mA, (25°C-125°C)	
V _{CE(on)}	Collector-to-Emitter Saturation Voltage	—	2.33	2.50	V	I _C = 50A I _C = 60A V _{GE} = 15V I _C = 50A, T _J = 125°C I _C = 60A, T _J = 125°C	5, 6
		—	2.50	2.75			7, 9
		—	2.79	3.1			10
		—	3.04	3.5			11
V _{GE(th)}	Gate Threshold Voltage	4.0	5.0	6.0		V _{CE} = V _{GE} , I _C = 250μA	9,10
ΔV _{GE(th)} /ΔT _J	Temperature Coeff. of Threshold Voltage	—	-12	—	mV/°C	V _{CE} = V _{GE} , I _C = 1.0mA, (25°C-125°C)	11, 12
g _{fe}	Forward Transconductance	—	34.4	—	S	V _{CE} = 50V, I _C = 60A, PW=80μs	
I _{CES}	Zero Gate Voltage Collector Current	—	—	500	μA	V _{GE} = 0V, V _{CE} = 1200V	
		—	650	1350		V _{GE} = 0V, V _{CE} = 1200V, T _J = 125°C	
V _{FM}	Diode Forward Voltage Drop	—	1.82	2.10	V	I _C = 50A	8
		—	1.93	2.20		I _C = 60A	
		—	1.96	2.20		I _C = 50A, T _J = 125°C	
		—	2.13	2.40		I _C = 60A, T _J = 125°C	
I _{GES}	Gate-to-Emitter Leakage Current	—	—	±100	nA	V _{GE} = ±20V	

Switching Characteristics @ T_J = 25°C (unless otherwise specified)

	Parameter	Min.	Typ.	Max.	Units	Conditions	Ref.Fig.		
Q _g	Total Gate Charge (turn-on)	—	340	510	nC	I _C = 60A	23		
Q _{ge}	Gate - Emitter Charge (turn-on)	—	40	60		V _{CC} = 600V	CT1		
Q _{gc}	Gate - Collector Charge (turn-on)	—	165	248		V _{GE} = 15V			
E _{on}	Turn-On Switching Loss	—	3214	4870	μJ	I _C = 60A, V _{CC} = 600V	CT4		
E _{off}	Turn-Off Switching Loss	—	4783	5450		V _{GE} = 15V, R _G = 4.7Ω, L = 200μH	WF1		
E _{tot}	Total Switching Loss	—	8000	10320		L _s = 150nH, T _J = 25°C	WF2		
E _{on}	Turn-On Switching Loss	—	5032	6890		T _J = 125°C	13,15		
E _{off}	Turn-Off Switching Loss	—	7457	8385	μJ	Energy losses include "tail" and diode reverse recovery.			
E _{tot}	Total Switching Loss	—	12500	15275					
t _{d(on)}	Turn-On Delay Time	—	72	94				I _C = 15A, V _{CC} = 600V	14, 16
t _r	Rise Time	—	32	45				V _{GE} = 15V, R _G = 4.7Ω, L = 200μH	CT4
t _{d(off)}	Turn-Off Delay Time	—	366	400	ns	L _s = 150nH, T _J = 125°C	WF1		
t _f	Fall Time	—	45	58			WF2		
C _{ies}	Input Capacitance	—	4300	—	pF	V _{GE} = 0V	22		
C _{oes}	Output Capacitance	—	395	—		V _{CC} = 30V			
C _{res}	Reverse Transfer Capacitance	—	160	—		f = 1.0MHz			
RBSOA	Reverse Bias Safe Operating Area	FULL SQUARE				T _J = 150°C, I _C = 240A, V _p = 1200V V _{CC} = 1000V, V _{GE} = +15V to 0V R _G = 4.7Ω	4 CT2		
SCSOA	Short Circuit Safe Operating Area	10	—	—	μs	T _J = 150°C, V _p = 1200V V _{CC} = 900V, V _{GE} = +15V to 0V, R _G = 4.7Ω	CT3 WF4		
E _{rec}	Reverse Recovery energy of the diode	—	3346	—	μJ	T _J = 125°C	17,18,19		
t _{rr}	Diode Reverse Recovery time	—	180	—	ns	V _{CC} = 600V, I _F = 60A, L = 200μH	20, 21		
I _{rr}	Diode Peak Reverse Recovery Current	—	50	—	A	V _{GE} = 15V, R _G = 4.7Ω, L _s = 150nH	CT4,WF3		

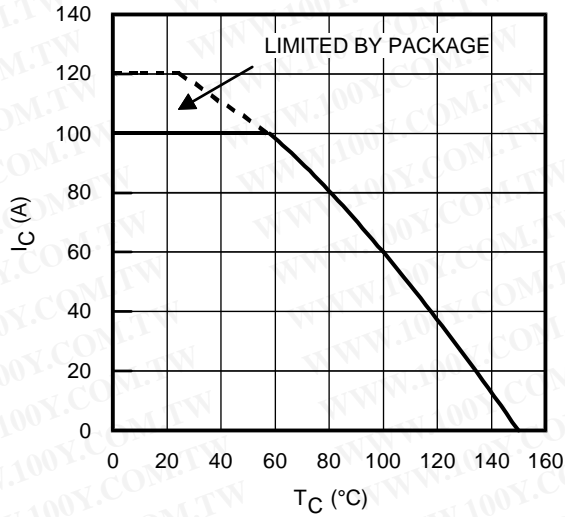

Fig. 1 - Maximum DC Collector Current vs. Case Temperature©

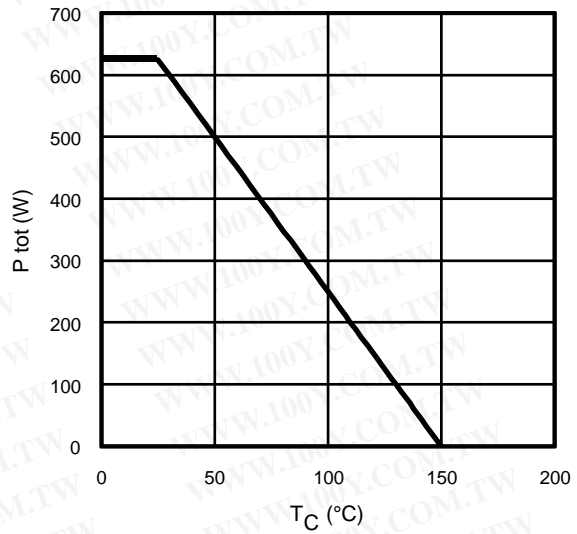

Fig. 2 - Power Dissipation vs. Case Temperature

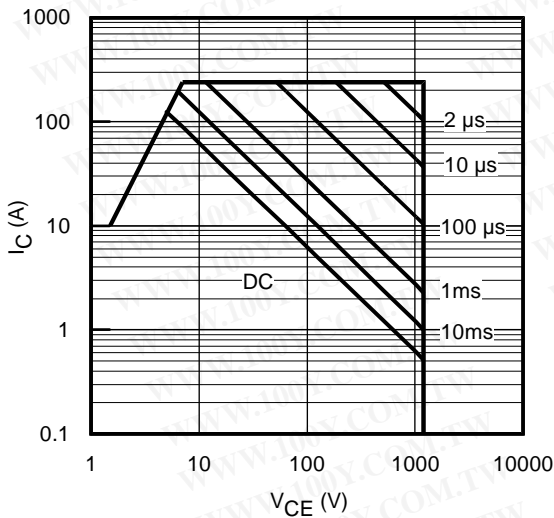

Fig. 3 - Forward SOA
 $T_C = 25^\circ\text{C}$; $T_{JS} \leq 150^\circ\text{C}$

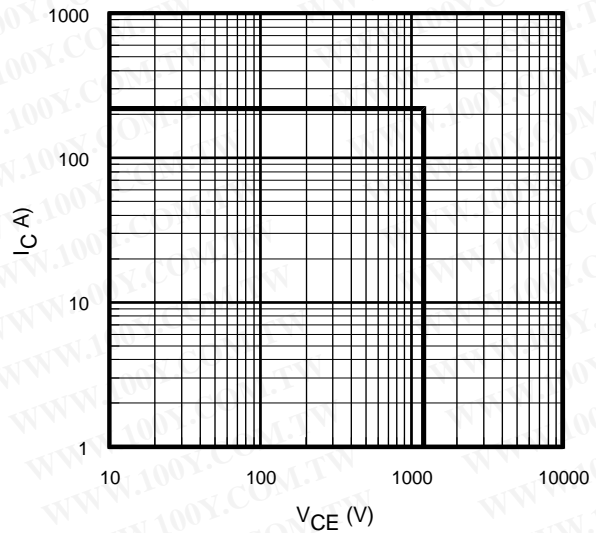

Fig. 4 - Reverse Bias SOA
 $T_J = 150^\circ\text{C}$; $V_{GE} = 15\text{V}$

IRG6S60B120KDP

International
IR Rectifier

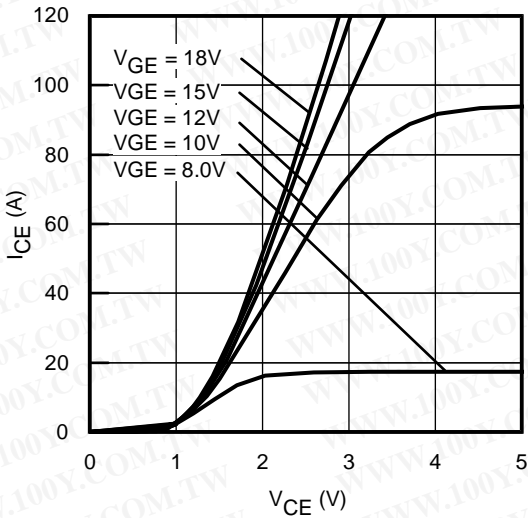

Fig. 5 - Typ. IGBT Output Characteristics
 $T_J = -40^\circ\text{C}$; $t_p = 80\mu\text{s}$

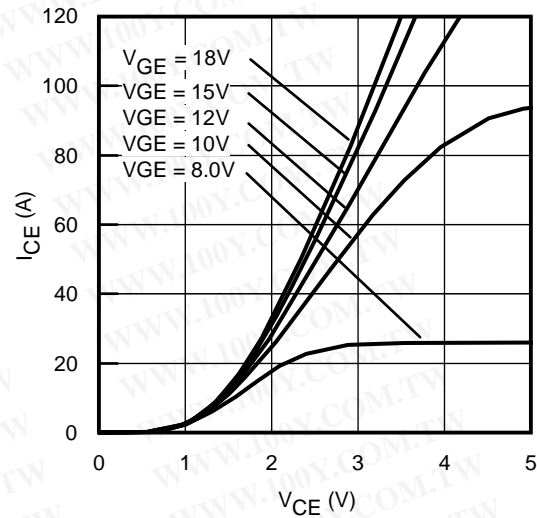

Fig. 6 - Typ. IGBT Output Characteristics
 $T_J = 25^\circ\text{C}$; $t_p = 80\mu\text{s}$

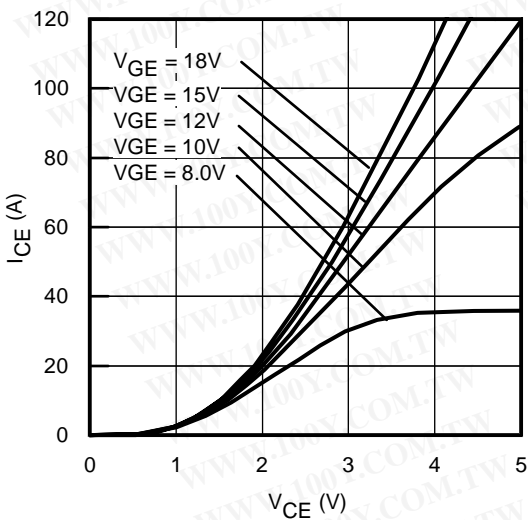

Fig. 7 - Typ. IGBT Output Characteristics
 $T_J = 125^\circ\text{C}$; $t_p = 80\mu\text{s}$

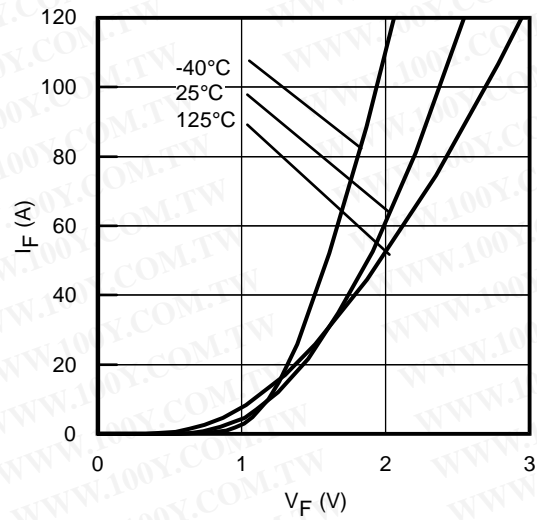

Fig. 8 - Typ. Diode Forward Characteristics
 $t_p = 80\mu\text{s}$

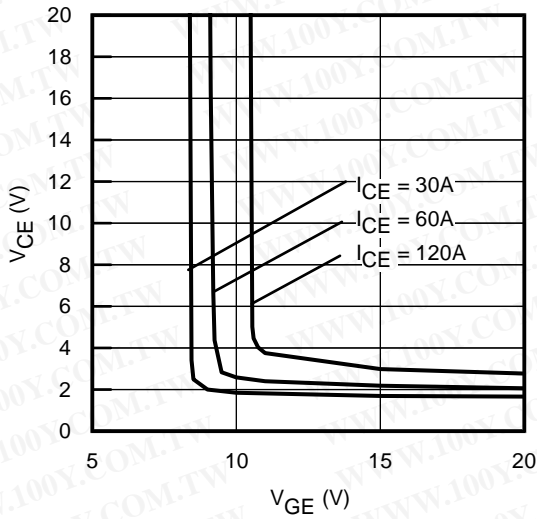

Fig. 9 - Typical V_{CE} vs. V_{GE}
 $T_J = -40^\circ\text{C}$

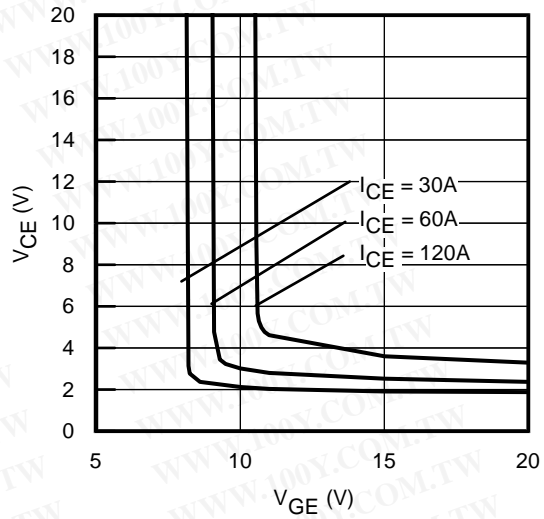

Fig. 10 - Typical V_{CE} vs. V_{GE}
 $T_J = 25^\circ\text{C}$

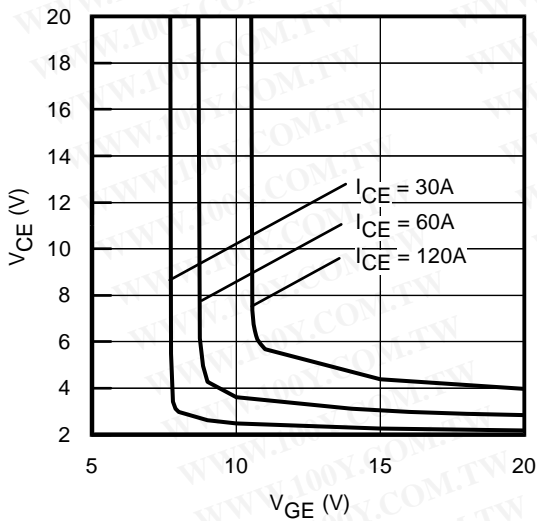

Fig. 11 - Typical V_{CE} vs. V_{GE}
 $T_J = 125^\circ\text{C}$

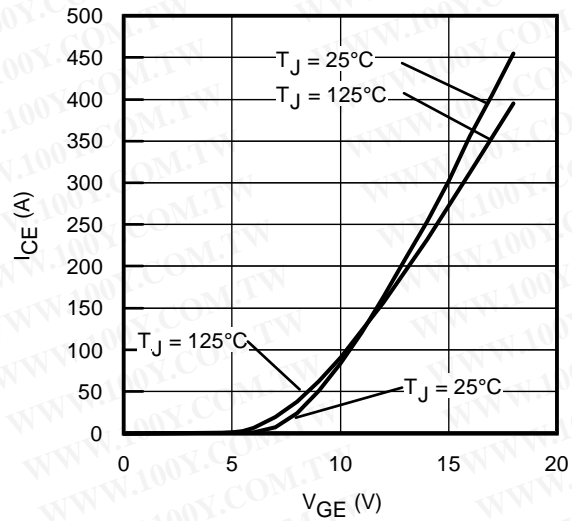

Fig. 12 - Typ. Transfer Characteristics
 $V_{CE} = 50\text{V}$; $t_p = 10\mu\text{s}$

IRG6S60B120KDP

International
IR Rectifier

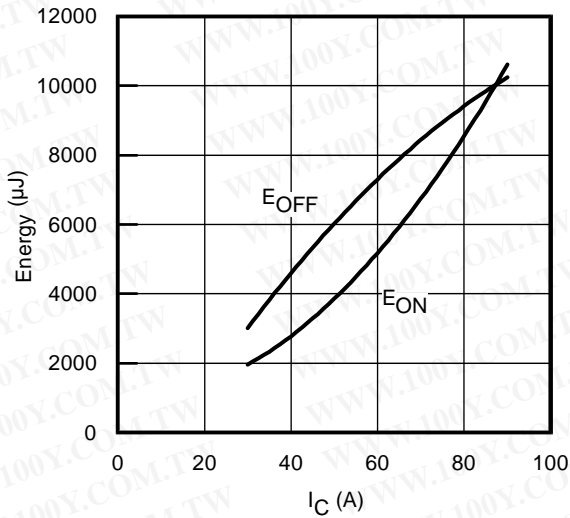

Fig. 13 - Typ. Energy Loss vs. I_C
 $T_J = 125^\circ\text{C}$; $L=200\mu\text{H}$; $V_{CE}=600\text{V}$
 $R_G=4.7\Omega$; $V_{GE}=15\text{V}$

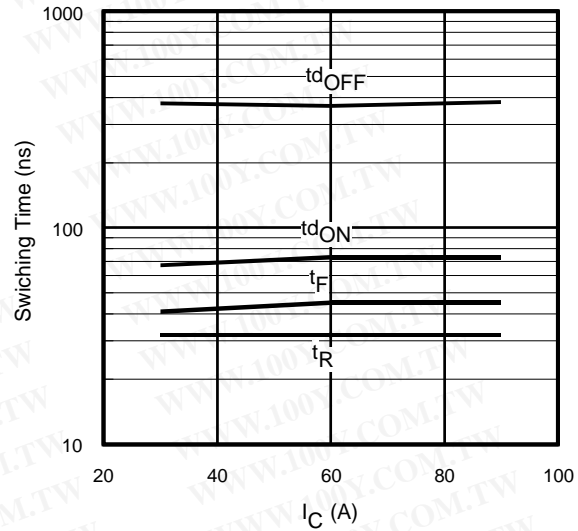

Fig. 14 - Typ. Switching Time vs. I_C
 $T_J = 125^\circ\text{C}$; $L=200\mu\text{H}$; $V_{CE}=600\text{V}$
 $R_G=4.7\Omega$; $V_{GE}=15\text{V}$

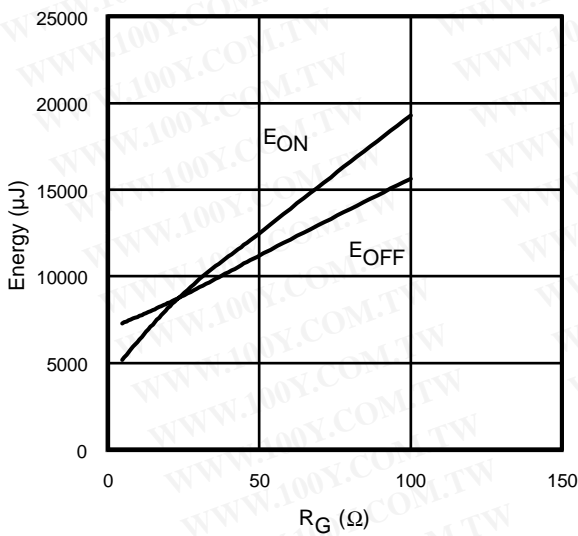

Fig. 15 - Typ. Energy Loss vs. R_G
 $T_J = 125^\circ\text{C}$; $L=200\mu\text{H}$; $V_{CE}=600\text{V}$
 $I_{CE}=60\text{A}$; $V_{GE}=15\text{V}$

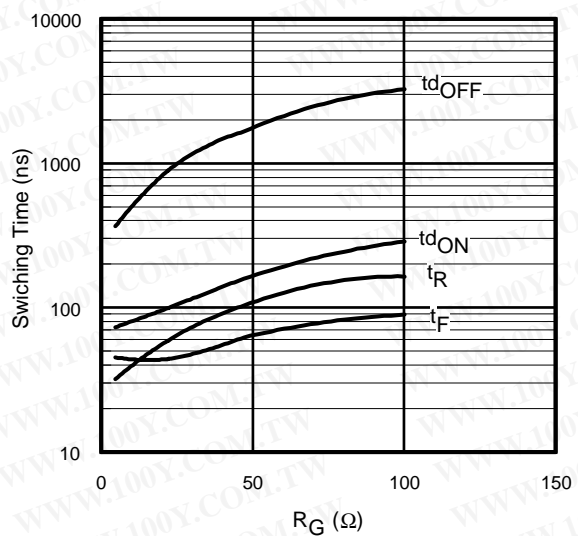

Fig. 16 - Typ. Switching Time vs. R_G
 $T_J = 125^\circ\text{C}$; $L=200\mu\text{H}$; $V_{CE}=600\text{V}$
 $I_{CE}=60\text{A}$; $V_{GE}=15\text{V}$

IRGPS60B120KDP

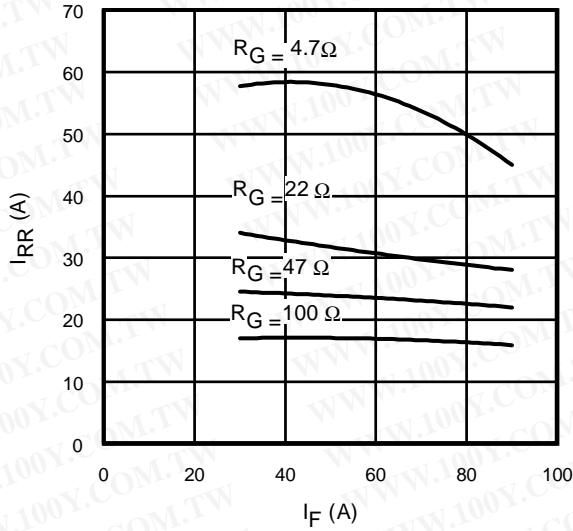

Fig. 17 - Typical Diode I_{RR} vs. I_F
 $T_J = 125^\circ\text{C}$

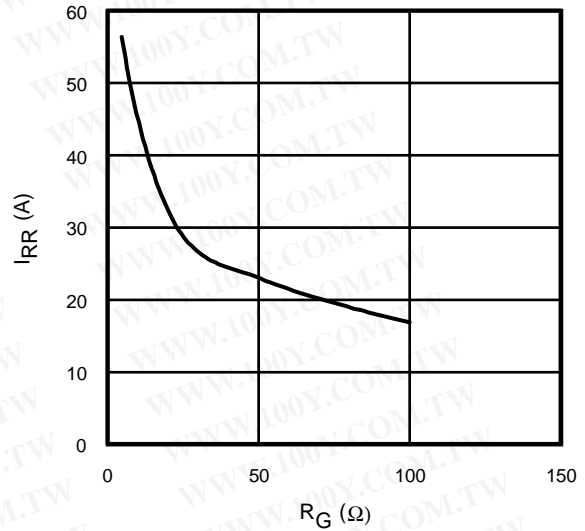

Fig. 18 - Typical Diode I_{RR} vs. R_G
 $T_J = 125^\circ\text{C}; I_F = 60\text{A}$

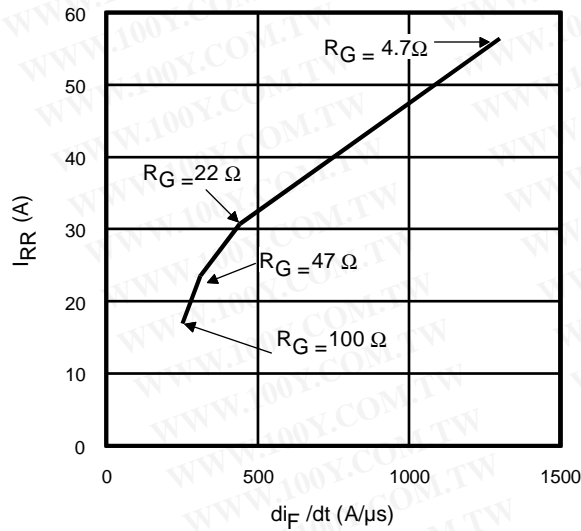

Fig. 19- Typical Diode I_{RR} vs. di_F/dt
 $V_{CC} = 600\text{V}; V_{GE} = 15\text{V};$
 $I_{CE} = 60\text{A}; T_J = 125^\circ\text{C}$

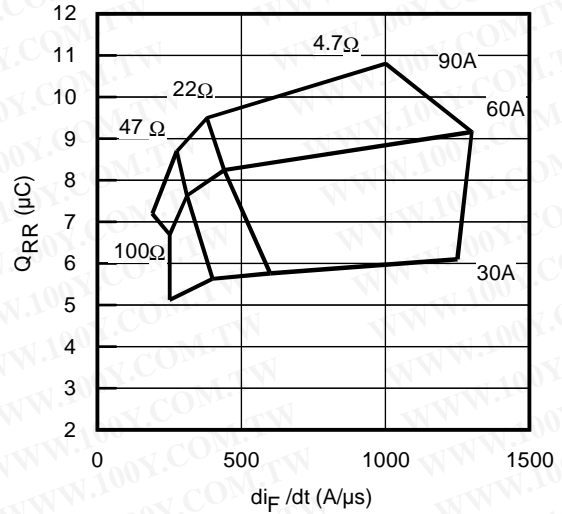

Fig. 20 - Typical Diode Q_{RR}
 $V_{CC} = 600\text{V}; V_{GE} = 15\text{V}; T_J = 125^\circ\text{C}$

IRG6S60B120KDP

International
IR Rectifier

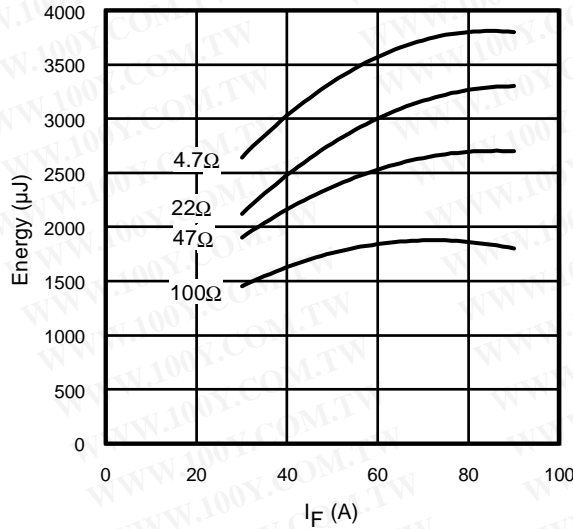

Fig. 21 - Typical Diode E_{RR} vs. I_F
 $T_J = 125^\circ\text{C}$

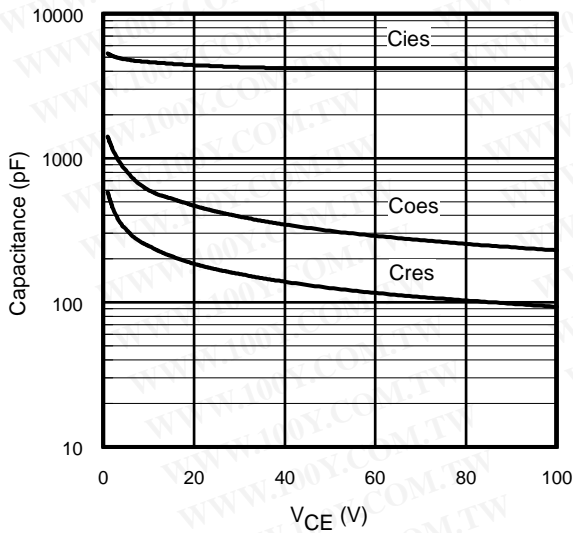

Fig. 22- Typ. Capacitance vs. V_{CE}
 $V_{GE} = 0\text{V}$; $f = 1\text{MHz}$

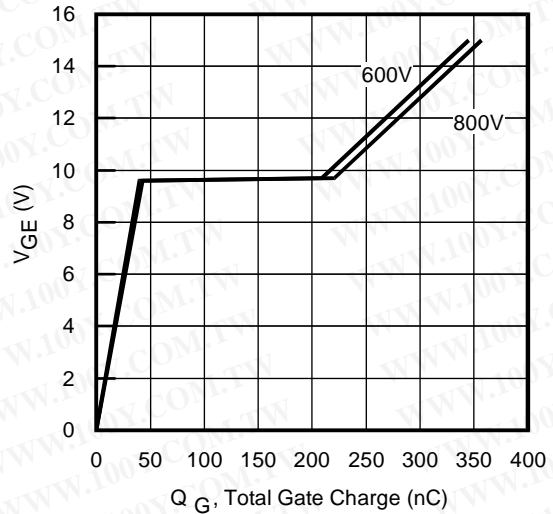

Fig. 23 - Typical Gate Charge vs. V_{GE}
 $I_{CE} = 60\text{A}$; $L = 600\mu\text{H}$

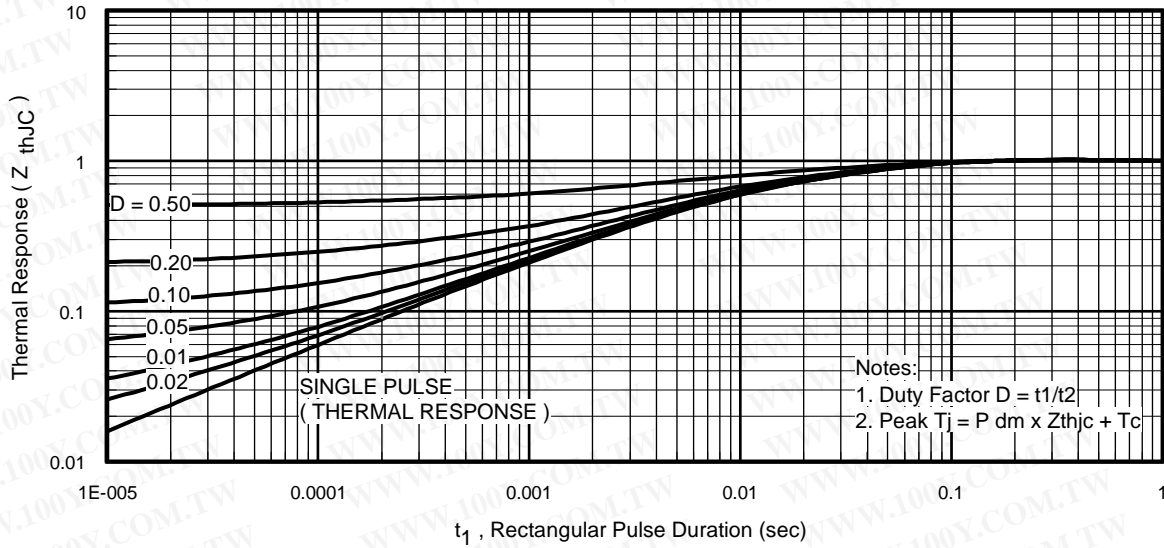

Fig 24. Normalized Transient Thermal Impedance, Junction-to-Case (IGBT)

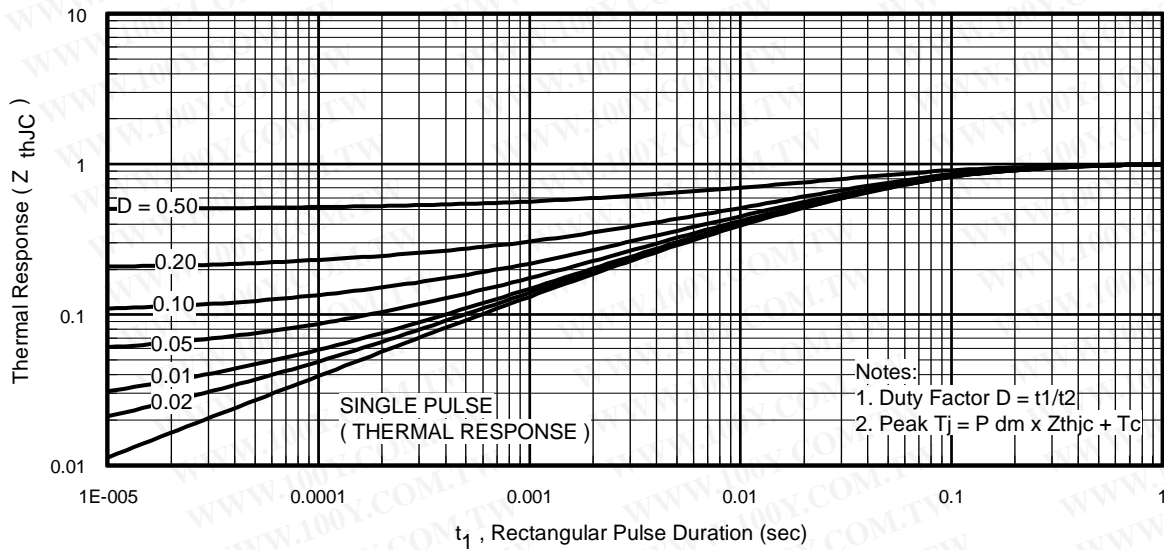

Fig 25. Normalized Transient Thermal Impedance, Junction-to-Case (DIODE)

IRGFS60B120KDP

International
IRF Rectifier

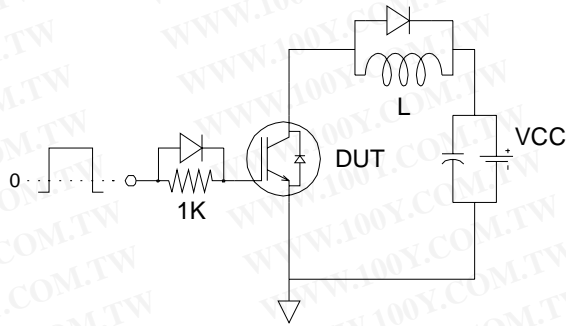

Fig.C.T.1 - Gate Charge Circuit (turn-on)

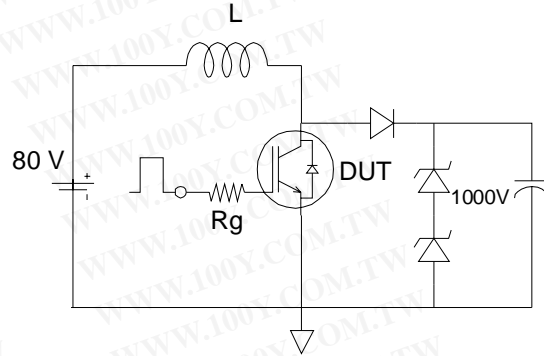

Fig.C.T.2 - RBSOA Circuit

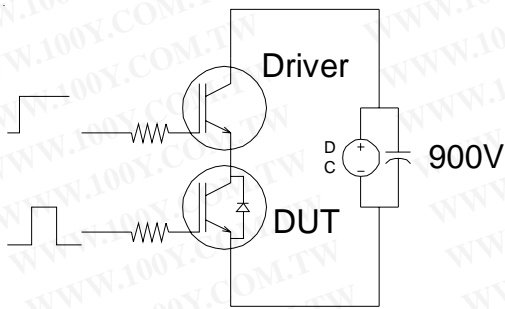

Fig.C.T.3 - RBSOA Circuit

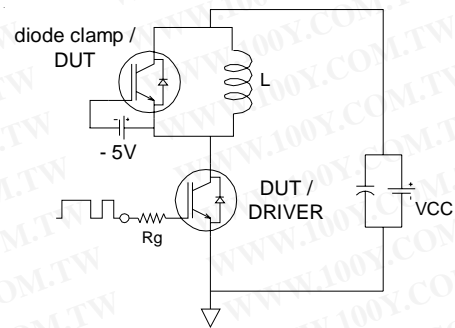

Fig.C.T.4 - RBSOA Circuit

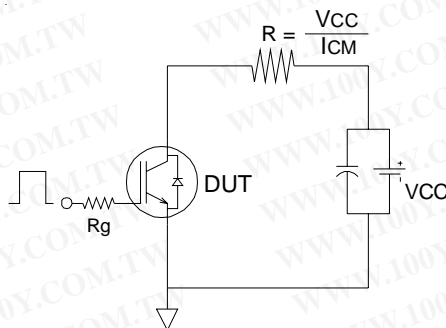

Fig.C.T.5 - RBSOA Circuit

IRGPS60B120KDP

Fig. WF1 - Typ. Turn-off Loss Waveform
@ $T_j=125^\circ\text{C}$ using Fig. CT.4

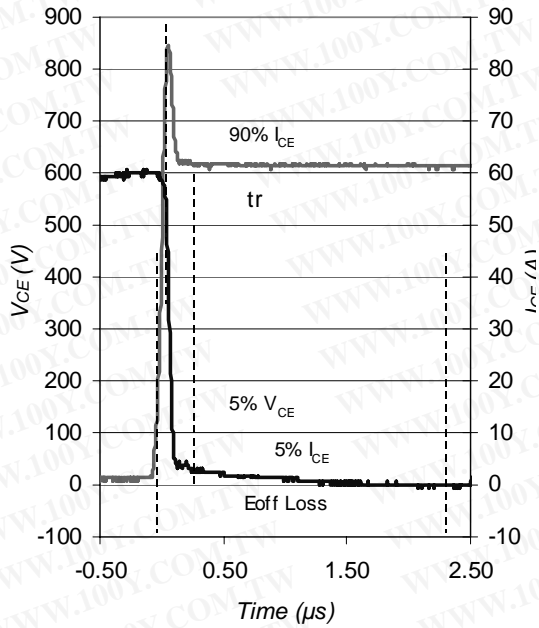

Fig. WF2 - Typ. Turn-On Loss Waveform
@ $T_j=125^\circ\text{C}$ using Fig. CT.4

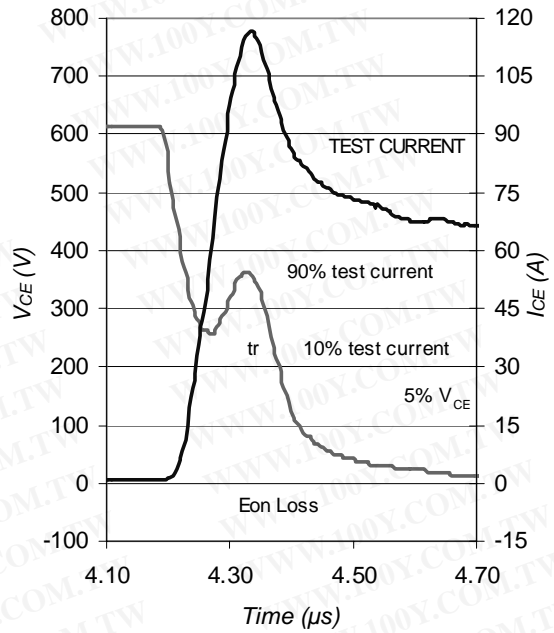

Fig. WF.3 - Typ. Diode Recovery
Waveform
@ $T_j=125^\circ\text{C}$ using Fig. CT.4

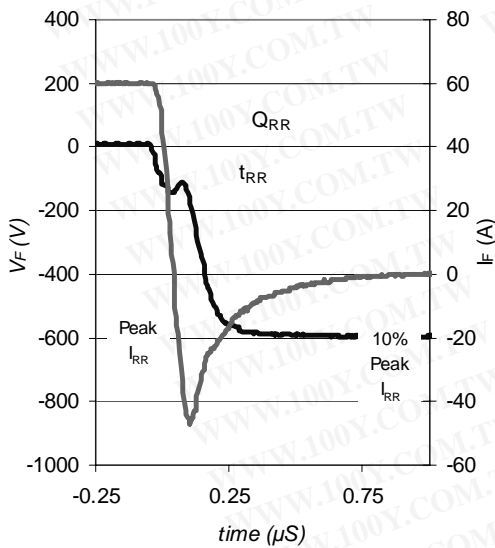
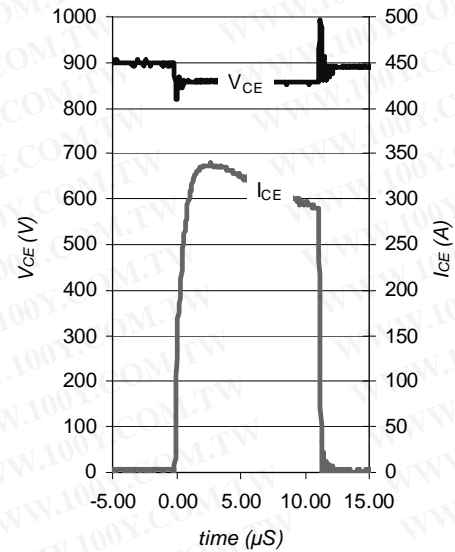

Fig. WF.4 - Typ. S.C. Waveform
@ $T_C=150^\circ\text{C}$ using Fig. CT.3



勝特力材料 886-3-5753170
 勝特力电子(上海) 86-21-34970699
 勝特力电子(深圳) 86-755-83298787
 Http://www.100y.com.tw

IRGPS60B120KDP Super-247™ Package Outline

International
IR Rectifier

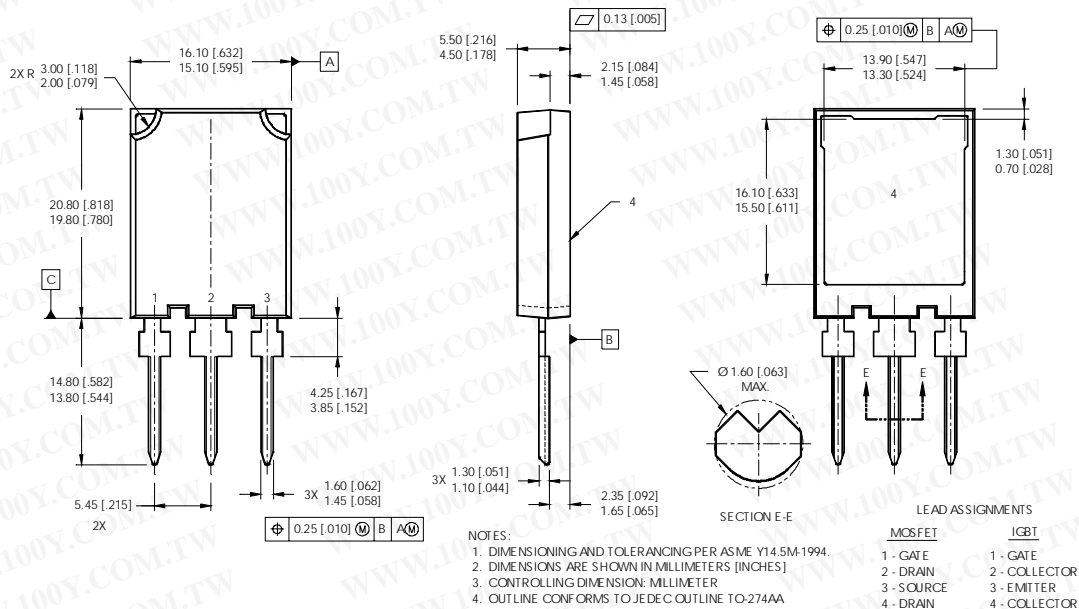

Super-247 (TO-274AA) Part Marking Information

EXAMPLE: THIS IS AN IRFPS37N50A WITH
 ASSEMBLY LOT CODE 1789
 ASSEMBLED ON WW 19, 1997
 IN THE ASSEMBLY LINE "C"

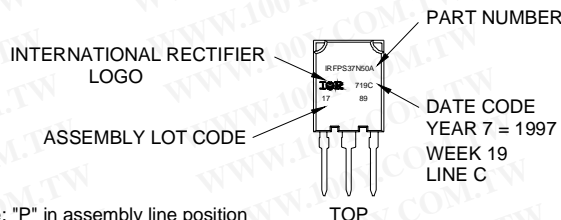

Notes:

Note: "P" in assembly line position indicates "Lead-Free"

- ① $V_{CC} = 80\% (V_{CES})$, $V_{GE} = 20V$, $L = 100 \mu H$, $R_G = 4.7\Omega$.
- ② Calculated continuous current based on maximum allowable junction temperature. Package limitation current is 105A.

Data and specifications subject to change without notice.

This product has been designed and qualified for the industrial market.

Qualification Standards can be found on IR's Web site.

International
IR Rectifier

IR WORLD HEADQUARTERS: 233 Kansas St., El Segundo, California 90245, USA Tel: (310) 252-7105

TAC Fax: (310) 252-7903

Visit us at www.irf.com for sales contact information.09/04

www.irf.com