

International **IR** Rectifier

PD - 94925A

INSULATED GATE BIPOLAR TRANSISTOR WITH
 ULTRAFAST SOFT RECOVERY DIODE

IRGB10B60KDPbF
 IRGS10B60KDPbF
 IRGSL10B60KDPbF

Features

- Low VCE (on) Non Punch Through IGBT Technology.
- Low Diode VF.
- 10µs Short Circuit Capability.
- Square RBSOA.
- Ultrasoft Diode Reverse Recovery Characteristics.
- Positive VCE (on) Temperature Coefficient.
- Lead-Free

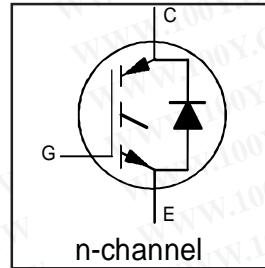

$V_{CES} = 600V$
 $I_C = 12A, T_C = 100^\circ C$
 $t_{sc} > 10\mu s, T_J = 150^\circ C$
 $V_{CE(on)} \text{ typ.} = 1.8V$

Benefits

- Benchmark Efficiency for Motor Control.
- Rugged Transient Performance.
- Low EMI.
- Excellent Current Sharing in Parallel Operation.

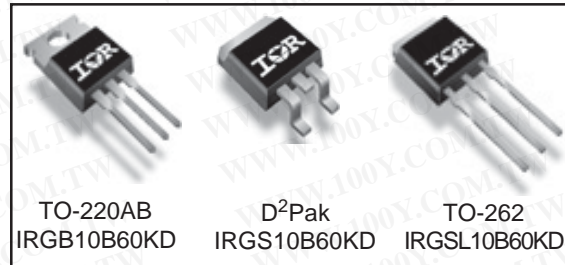

Absolute Maximum Ratings

	Parameter	Max.	Units
V_{CES}	Collector-to-Emitter Voltage	600	V
$I_C @ T_C = 25^\circ C$	Continuous Collector Current	22	A
$I_C @ T_C = 100^\circ C$	Continuous Collector Current	12	
I_{CM}	Pulsed Collector Current	44	
I_{LM}	Clamped Inductive Load Current ④	44	
$I_F @ T_C = 25^\circ C$	Diode Continuous Forward Current	22	A
$I_F @ T_C = 100^\circ C$	Diode Continuous Forward Current	10	
I_{FM}	Diode Maximum Forward Current	44	
V_{GE}	Gate-to-Emitter Voltage	± 20	V
$P_D @ T_C = 25^\circ C$	Maximum Power Dissipation	156	W
$P_D @ T_C = 100^\circ C$	Maximum Power Dissipation	62	
T_J	Operating Junction and	-55 to +150	$^\circ C$
T_{STG}	Storage Temperature Range		
	Soldering Temperature, for 10 sec.	300 (0.063 in. (1.6mm) from case)	

Thermal Resistance

	Parameter	Min.	Typ.	Max.	Units
$R_{\theta JC}$	Junction-to-Case - IGBT	—	—	0.8	$^\circ C/W$
$R_{\theta JC}$	Junction-to-Case - Diode	—	—	3.4	
$R_{\theta CS}$	Case-to-Sink, flat, greased surface	—	0.50	—	
$R_{\theta JA}$	Junction-to-Ambient, typical socket mount①	—	—	62	
$R_{\theta JA}$	Junction-to-Ambient (PCB Mount, steady state)②	—	—	40	
Wt	Weight	—	1.44	—	g

IRG/B/S/SL10B60KDPbF

International
IR Rectifier

Electrical Characteristics @ T_J = 25°C (unless otherwise specified)

	Parameter	Min.	Typ.	Max.	Units	Conditions	Ref.Fig.
V _{(BR)CES}	Collector-to-Emitter Breakdown Voltage	600	—	—	V	V _{GE} = 0V, I _C = 500μA	
ΔV _{(BR)CES} /ΔT _J	Temperature Coeff. of Breakdown Voltage	—	0.3	—	V/°C	V _{GE} = 0V, I _C = 1.0mA, (25°C-150°C)	
V _{CE(on)}	Collector-to-Emitter Saturation Voltage	1.5	1.80	2.20	V	I _C = 10A, V _{GE} = 15V	5, 6,7
		—	2.20	2.50		I _C = 10A, V _{GE} = 15V T _J = 150°C	9,10,11
V _{GE(th)}	Gate Threshold Voltage	3.5	4.5	5.5	V	V _{CE} = V _{GE} , I _C = 250μA	9,10,11
ΔV _{GE(th)} /ΔT _J	Temperature Coeff. of Threshold Voltage	—	-10	—	mV/°C	V _{CE} = V _{GE} , I _C = 1.0mA, (25°C-150°C)	12
g _{fe}	Forward Transconductance	—	7.0	—	S	V _{CE} = 50V, I _C = 10A, PW=80μs	
I _{CES}	Zero Gate Voltage Collector Current	—	3.0	150	μA	V _{GE} = 0V, V _{CE} = 600V	
		—	300	700		V _{GE} = 0V, V _{CE} = 600V, T _J = 150°C	
V _{FM}	Diode Forward Voltage Drop	—	1.30	1.45	V	I _C = 10A	8
		—	1.30	1.45		I _C = 10A T _J = 150°C	
I _{GES}	Gate-to-Emitter Leakage Current	—	—	±100	nA	V _{GE} = ±20V	

Switching Characteristics @ T_J = 25°C (unless otherwise specified)

	Parameter	Min.	Typ.	Max.	Units	Conditions	Ref.Fig.
Q _g	Total Gate Charge (turn-on)	—	38	—	nC	I _C = 10A	CT1
Q _{ge}	Gate - Emitter Charge (turn-on)	—	4.3	—		V _{CC} = 400V	
Q _{gc}	Gate - Collector Charge (turn-on)	—	16.3	—		V _{GE} = 15V	
E _{on}	Turn-On Switching Loss	—	140	247	μJ	I _C = 10A, V _{CC} = 400V	CT4
E _{off}	Turn-Off Switching Loss	—	250	360		V _{GE} = 15V, R _G = 47Ω, L = 200μH	
E _{tot}	Total Switching Loss	—	390	607		L _s = 150nH T _J = 25°C ③	
t _{d(on)}	Turn-On Delay Time	—	30	39	ns	I _C = 10A, V _{CC} = 400V	CT4
t _r	Rise Time	—	20	29		V _{GE} = 15V, R _G = 47Ω, L = 200μH	
t _{d(off)}	Turn-Off Delay Time	—	230	262		L _s = 150nH, T _J = 25°C	
t _f	Fall Time	—	23	32			
E _{on}	Turn-On Switching Loss	—	230	340	μJ	I _C = 10A, V _{CC} = 400V	CT4
E _{off}	Turn-Off Switching Loss	—	350	464		V _{GE} = 15V, R _G = 47Ω, L = 200μH	
E _{tot}	Total Switching Loss	—	580	804		L _s = 150nH T _J = 150°C ③	
t _{d(on)}	Turn-On Delay Time	—	30	39	ns	I _C = 10A, V _{CC} = 400V	14, 16
t _r	Rise Time	—	20	28		V _{GE} = 15V, R _G = 47Ω, L = 200μH	
t _{d(off)}	Turn-Off Delay Time	—	250	274		L _s = 150nH, T _J = 150°C	
t _f	Fall Time	—	26	34			
C _{ies}	Input Capacitance	—	620	—	pF	V _{GE} = 0V	
C _{oes}	Output Capacitance	—	62	—		V _{CC} = 30V	
C _{res}	Reverse Transfer Capacitance	—	22	—		f = 1.0MHz	
RBSOA	Reverse Bias Safe Operating Area	FULL SQUARE				T _J = 150°C, I _C = 44A, V _p = 600V V _{CC} = 500V, V _{GE} = +15V to 0V, R _G = 47Ω	4 CT2
SCSOA	Short Circuit Safe Operating Area	10	—	—	μs	T _J = 150°C, V _p = 600V, R _G = 47Ω V _{CC} = 360V, V _{GE} = +15V to 0V	CT3 WF4
E _{rec}	Reverse Recovery energy of the diode	—	245	330	μJ	T _J = 150°C	17,18,19
t _{rr}	Diode Reverse Recovery time	—	90	105	ns	V _{CC} = 400V, I _F = 10A, L = 200μH	20, 21
I _{rr}	Diode Peak Reverse Recovery Current	—	19	22	A	V _{GE} = 15V, R _G = 47Ω, L _s = 150nH	CT4, WF3

Note ① to ④ are on page 15

IRG/B/S/SL10B60KDPbF

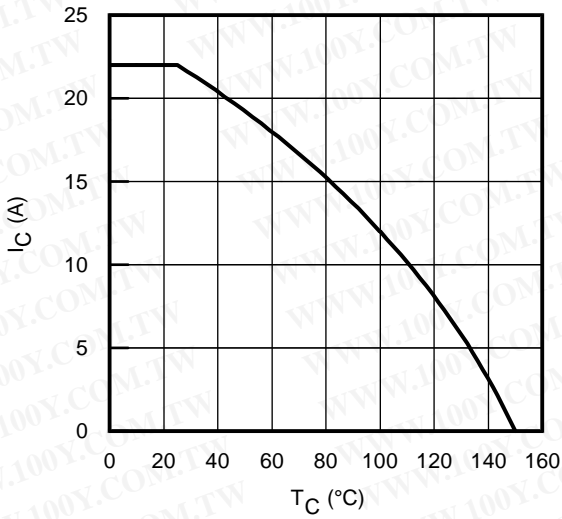

Fig. 1 - Maximum DC Collector Current vs. Case Temperature

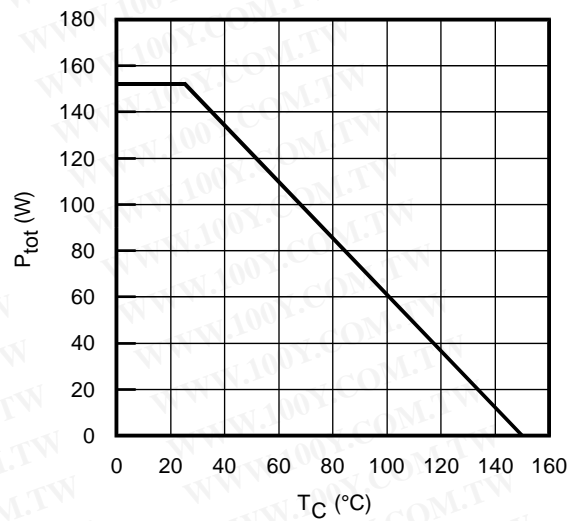

Fig. 2 - Power Dissipation vs. Case Temperature

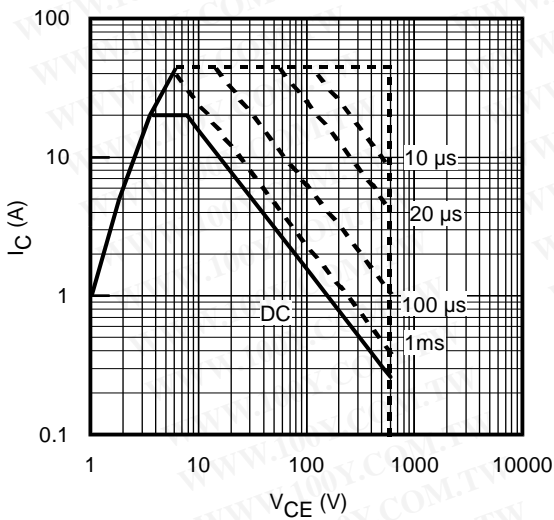

Fig. 3 - Forward SOA
 $T_C = 25^\circ\text{C}$; $T_J \leq 150^\circ\text{C}$

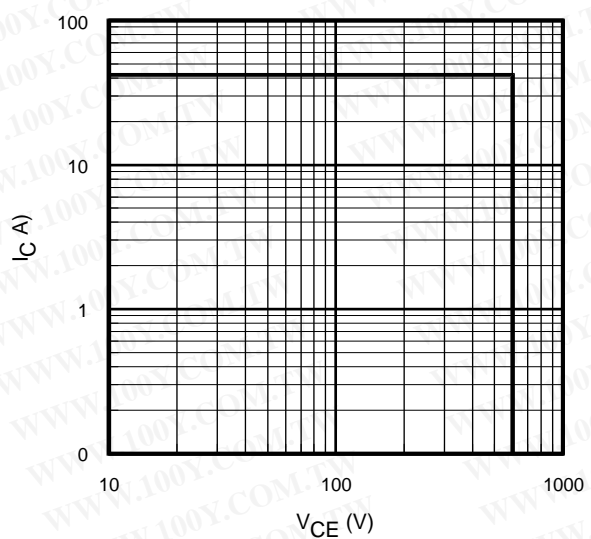

Fig. 4 - Reverse Bias SOA
 $T_J = 150^\circ\text{C}$; $V_{GE} = 15\text{V}$

IRG/B/S/SL10B60KDPbF

International
IR Rectifier

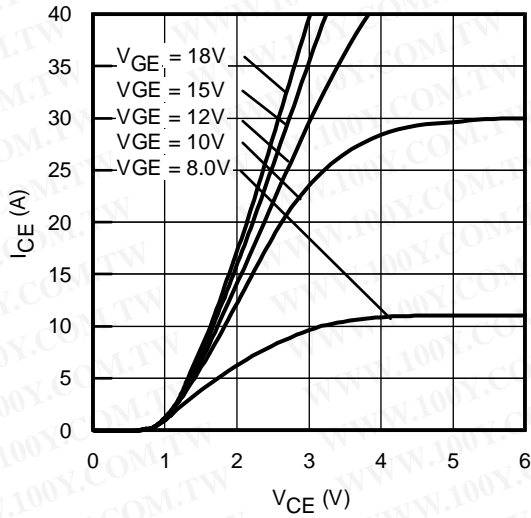

Fig. 5 - Typ. IGBT Output Characteristics
 $T_J = -40^\circ\text{C}$; $t_p = 80\mu\text{s}$

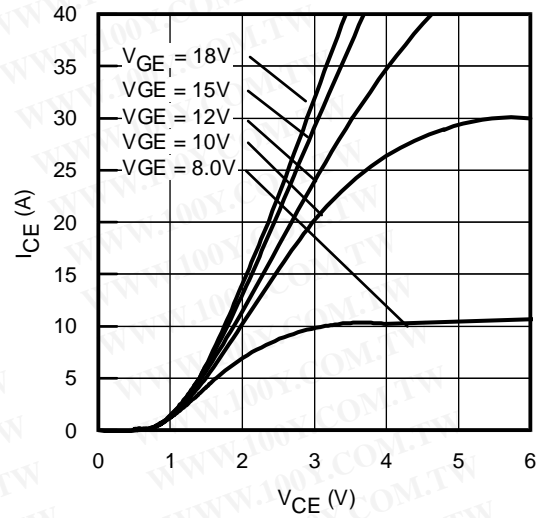

Fig. 6 - Typ. IGBT Output Characteristics
 $T_J = 25^\circ\text{C}$; $t_p = 80\mu\text{s}$

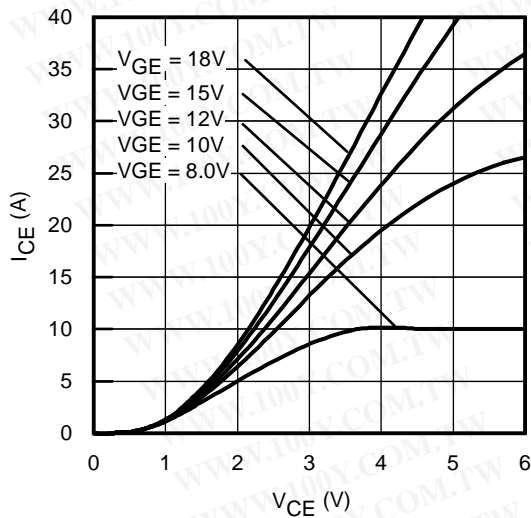

Fig. 7 - Typ. IGBT Output Characteristics
 $T_J = 150^\circ\text{C}$; $t_p = 80\mu\text{s}$

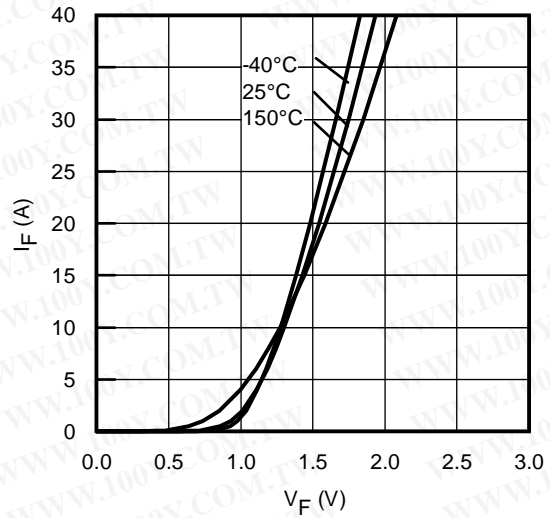

Fig. 8 - Typ. Diode Forward Characteristics
 $t_p = 80\mu\text{s}$

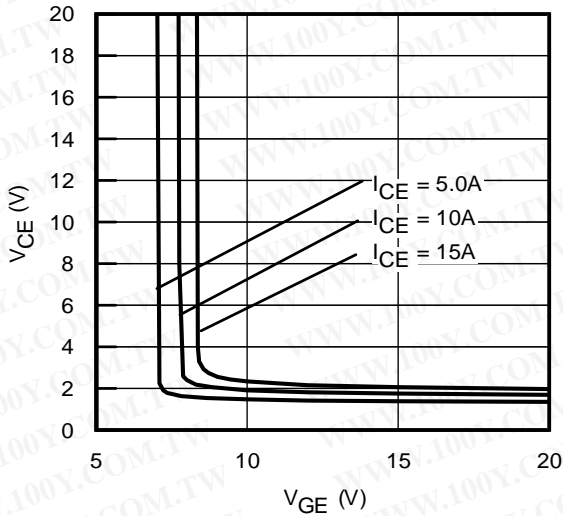

Fig. 9 - Typical V_{CE} vs. V_{GE}
 $T_J = -40^\circ\text{C}$

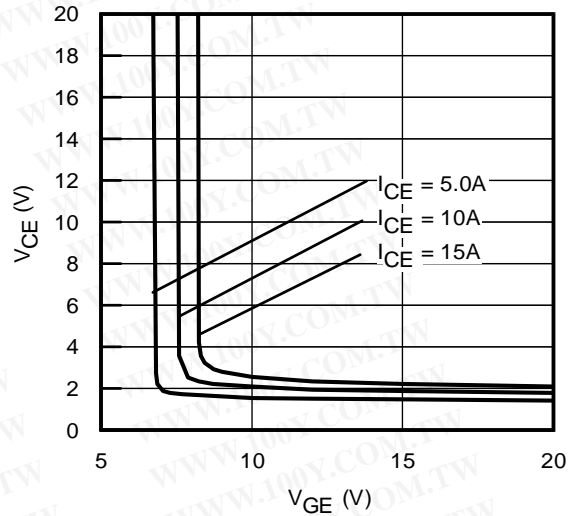

Fig. 10 - Typical V_{CE} vs. V_{GE}
 $T_J = 25^\circ\text{C}$

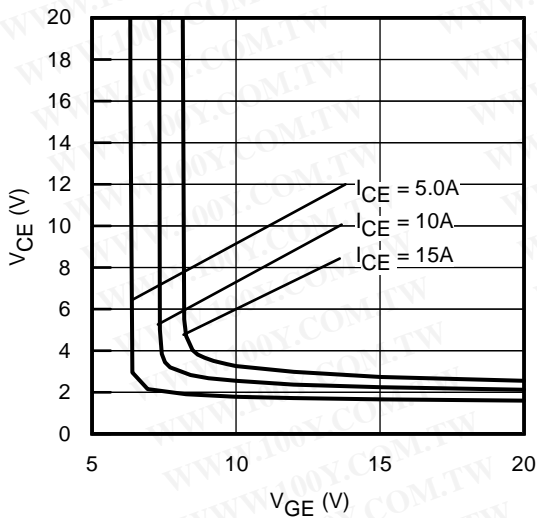

Fig. 11 - Typical V_{CE} vs. V_{GE}
 $T_J = 150^\circ\text{C}$

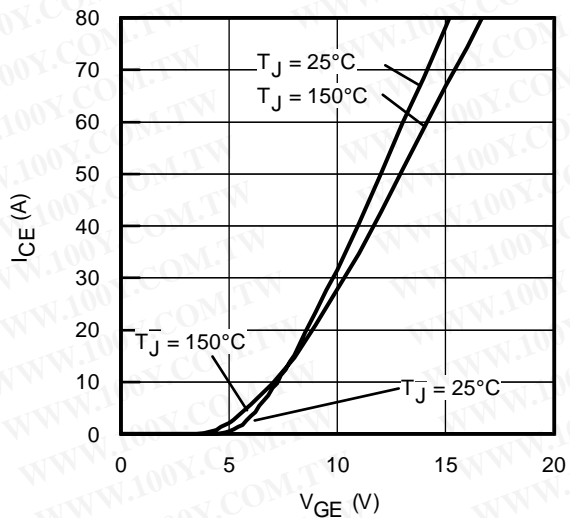

Fig. 12 - Typ. Transfer Characteristics
 $V_{CE} = 50\text{V}$; $t_p = 10\mu\text{s}$

IRG/B/S/SL10B60KDPbF

International
IRF Rectifier

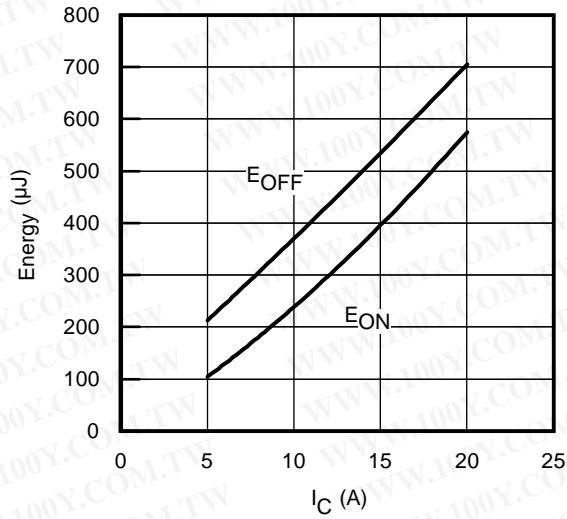

Fig. 13 - Typ. Energy Loss vs. I_C
 $T_J = 150^\circ\text{C}$; $L=200\mu\text{H}$; $V_{CE}=400\text{V}$
 $R_G=47\Omega$; $V_{GE}=15\text{V}$

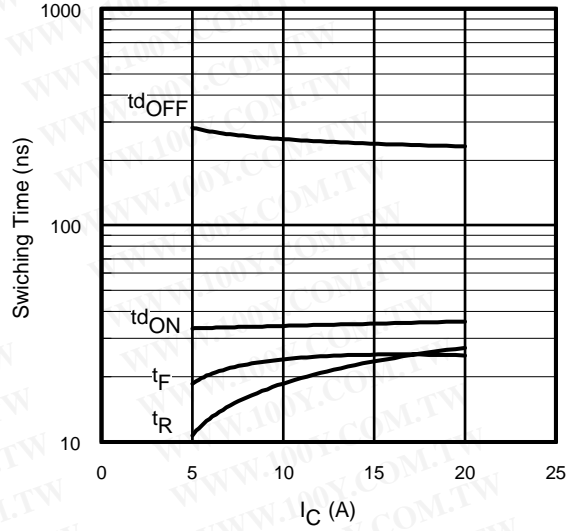

Fig. 14 - Typ. Switching Time vs. I_C
 $T_J = 150^\circ\text{C}$; $L=200\mu\text{H}$; $V_{CE}=400\text{V}$
 $R_G=47\Omega$; $V_{GE}=15\text{V}$

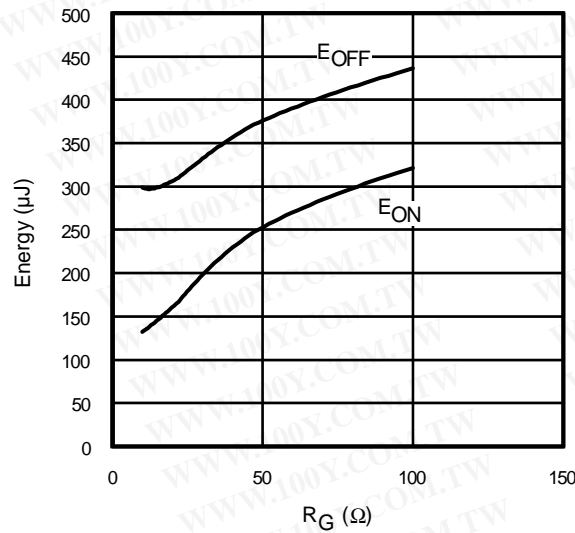

Fig. 15 - Typ. Energy Loss vs. R_G
 $T_J = 150^\circ\text{C}$; $L=200\mu\text{H}$; $V_{CE}=400\text{V}$
 $I_{CE}=10\text{A}$; $V_{GE}=15\text{V}$

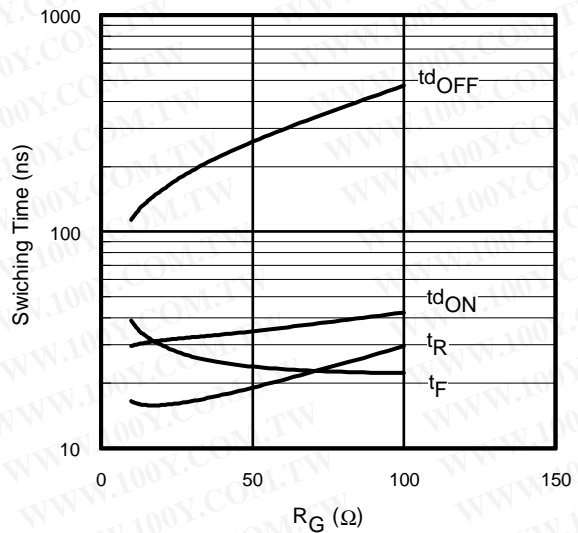

Fig. 16 - Typ. Switching Time vs. R_G
 $T_J = 150^\circ\text{C}$; $L=200\mu\text{H}$; $V_{CE}=400\text{V}$
 $I_{CE}=10\text{A}$; $V_{GE}=15\text{V}$

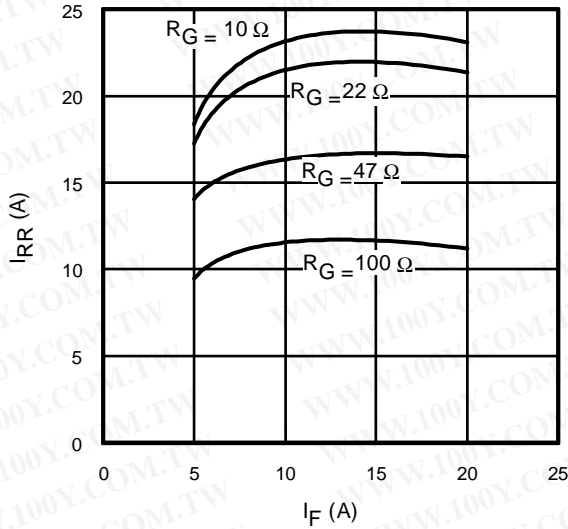

Fig. 17 - Typical Diode I_{RR} vs. I_F
 $T_J = 150^\circ\text{C}$

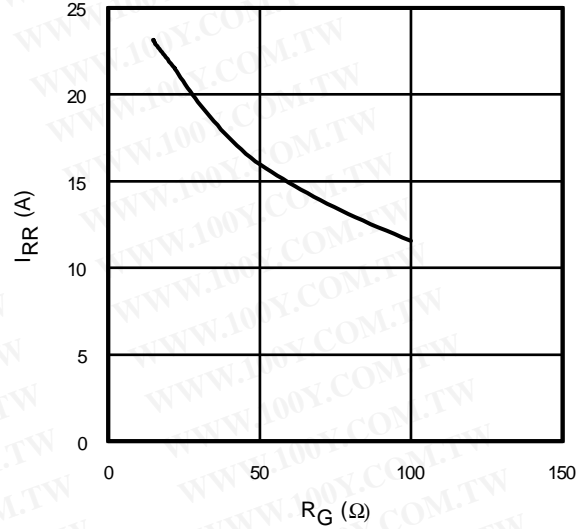

Fig. 18 - Typical Diode I_{RR} vs. R_G
 $T_J = 150^\circ\text{C}$; $I_F = 10\text{A}$

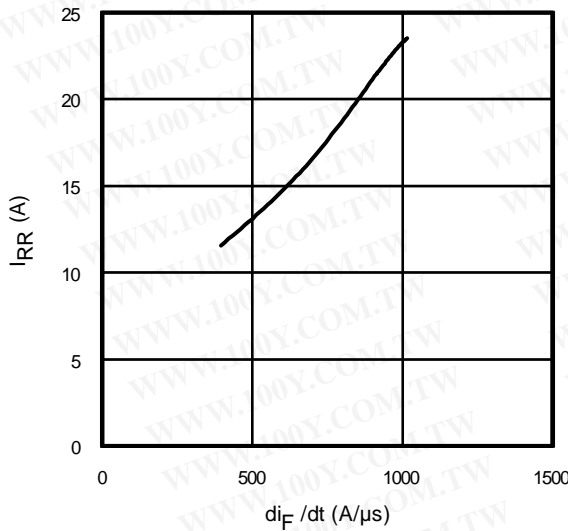

Fig. 19 - Typical Diode I_{RR} vs. di_F/dt
 $V_{CC} = 400\text{V}$; $V_{GE} = 15\text{V}$;
 $I_{CE} = 10\text{A}$; $T_J = 150^\circ\text{C}$

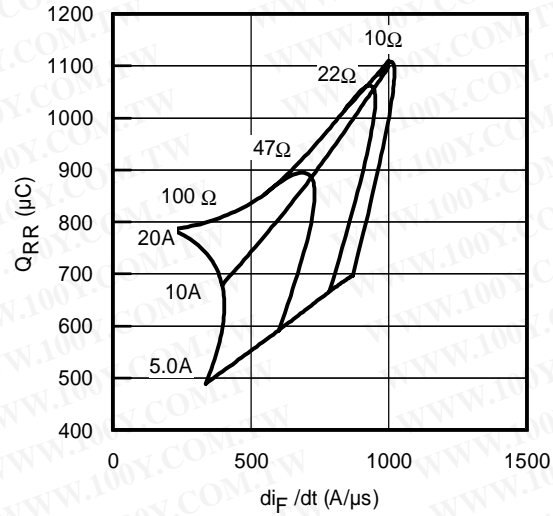

Fig. 20 - Typical Diode Q_{RR}
 $V_{CC} = 400\text{V}$; $V_{GE} = 15\text{V}$; $T_J = 150^\circ\text{C}$

IRG/B/S/SL10B60KDPbF

International
IR Rectifier

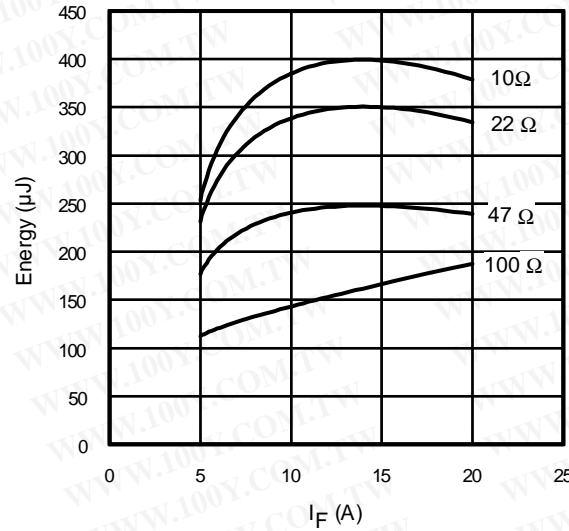

Fig. 21 - Typical Diode E_{RR} vs. I_F
 $T_J = 150^\circ\text{C}$

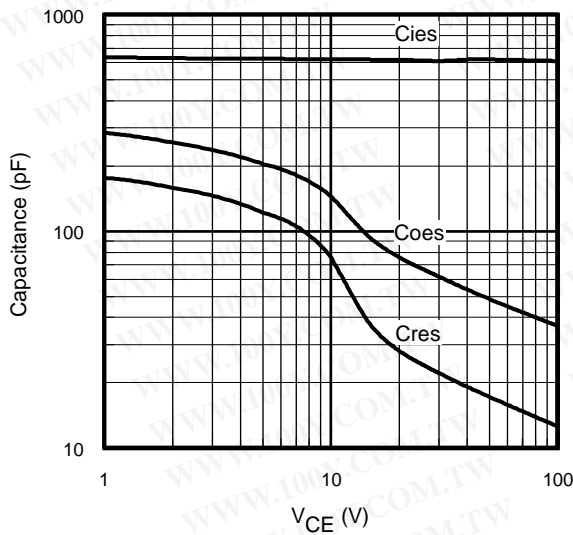

Fig. 22- Typ. Capacitance vs. V_{CE}
 $V_{GE} = 0\text{V}$; $f = 1\text{MHz}$

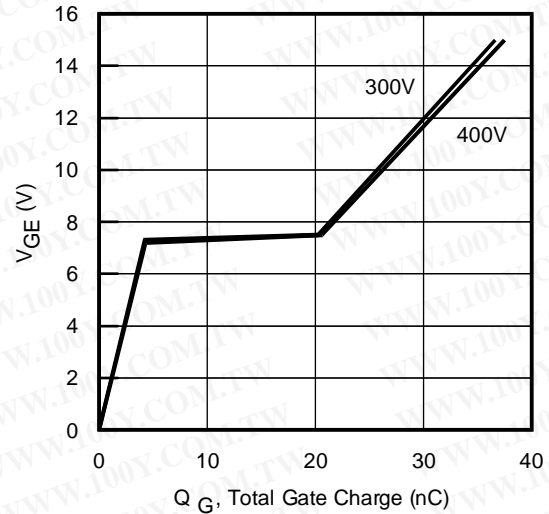

Fig. 23 - Typical Gate Charge vs. V_{GE}
 $I_{CE} = 10\text{A}$; $L = 600\mu\text{H}$

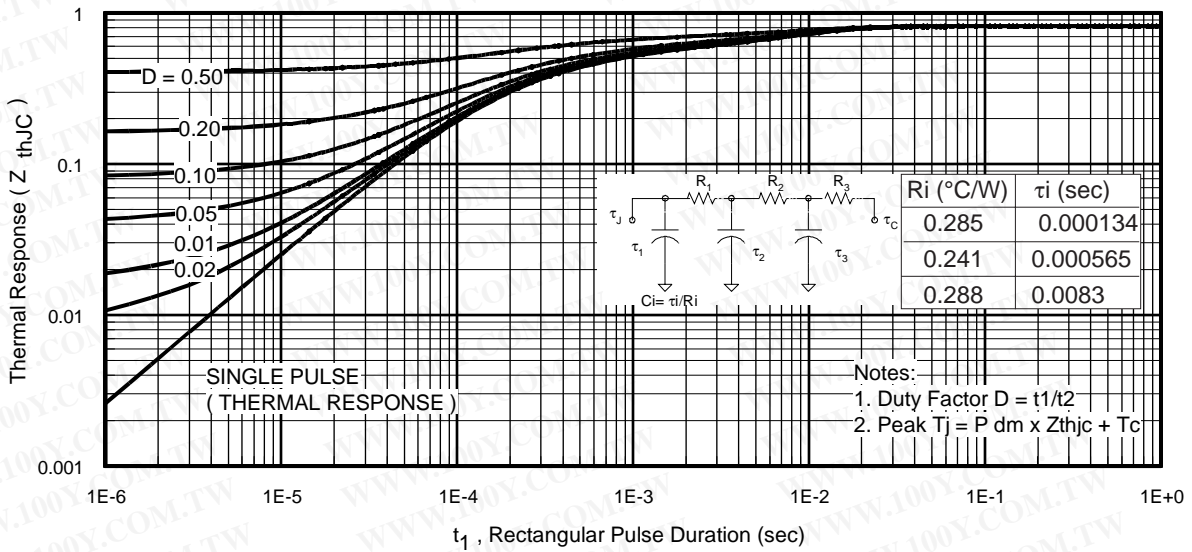

Fig 24. Maximum Transient Thermal Impedance, Junction-to-Case (IGBT)

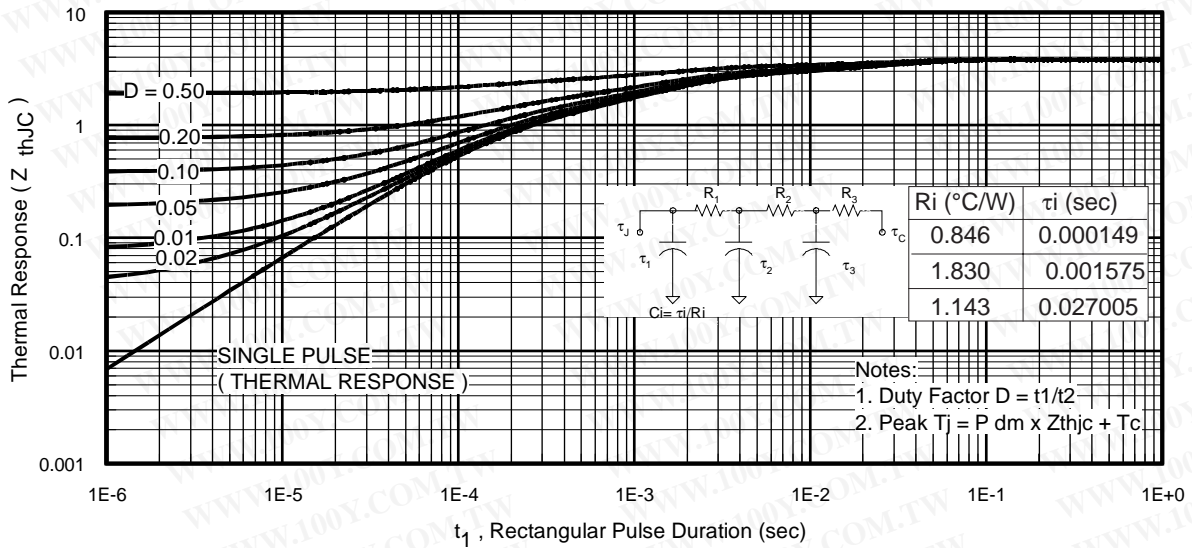

Fig 25. Maximum Transient Thermal Impedance, Junction-to-Case (DIODE)

IRG/B/S/SL10B60KDPbF

International
IR Rectifier

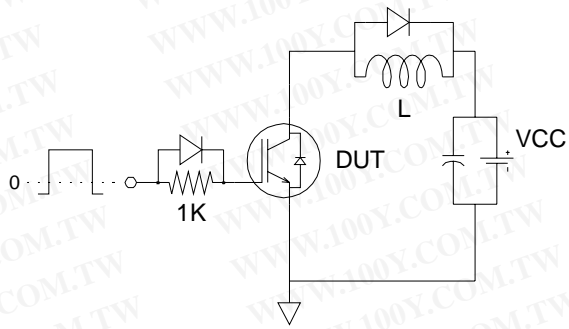

Fig.C.T.1 - Gate Charge Circuit (turn-off)

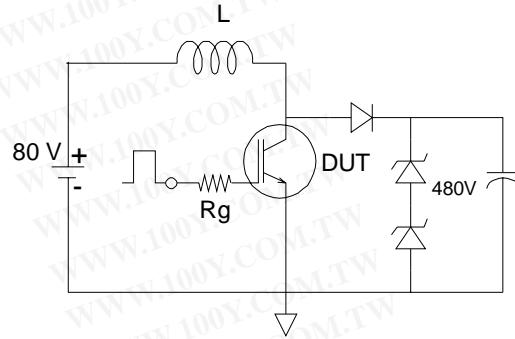

Fig.C.T.2 - RBSOA Circuit

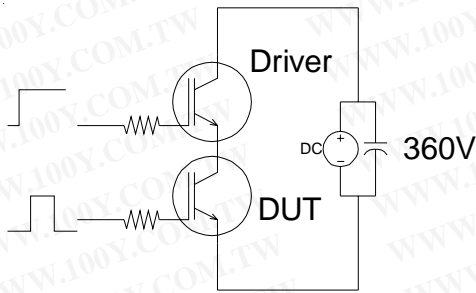

Fig.C.T.3 - S.C.SOA Circuit

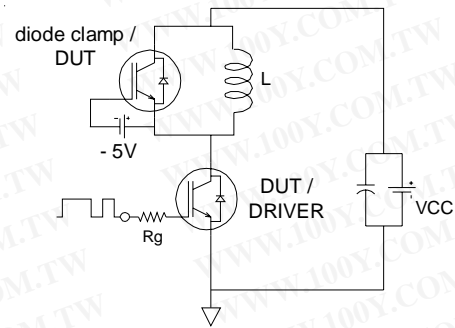

Fig.C.T.4 - Switching Loss Circuit

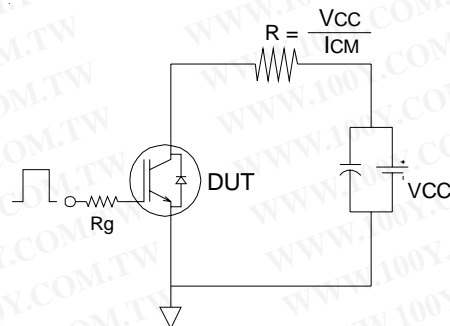

Fig.C.T.5 - Resistive Load Circuit

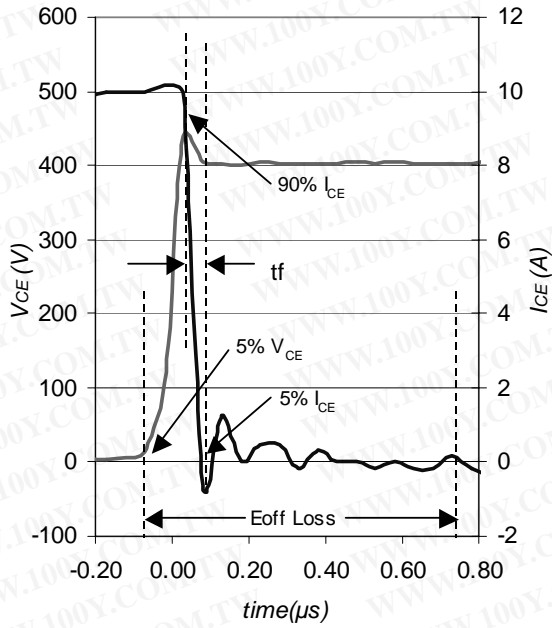

Fig. WF1- Typ. Turn-off Loss Waveform
@ T_J = 150°C using Fig. CT.4

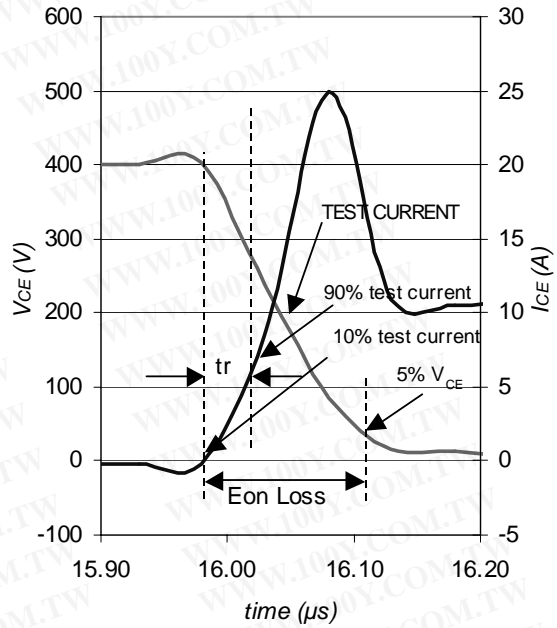

Fig. WF2- Typ. Turn-on Loss Waveform
@ T_J = 150°C using Fig. CT.4

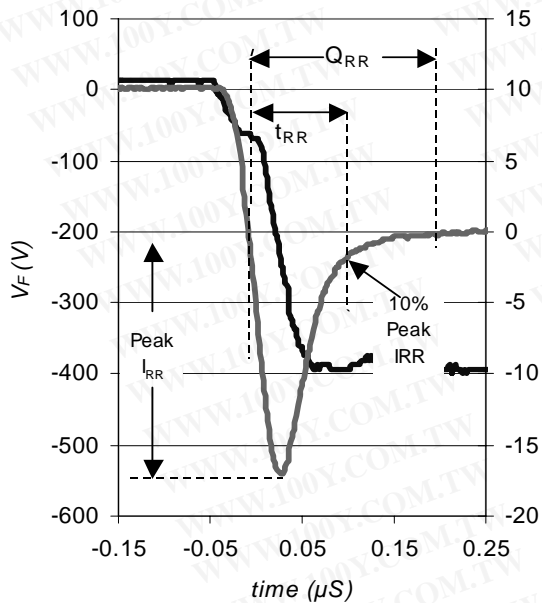

Fig. WF3- Typ. Diode Recovery Waveform
@ T_J = 150°C using Fig. CT.4

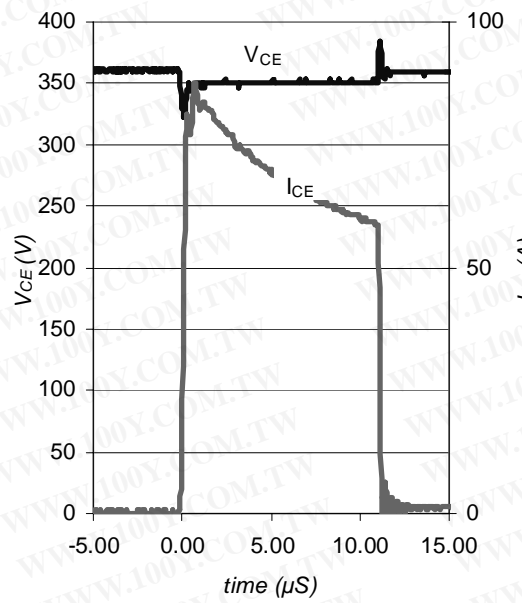

Fig. WF4- Typ. S.C Waveform
@ T_J = 150°C using Fig. CT.3

IRG/B/S/SL10B60KDPbF

International
IR Rectifier

TO-220AB Package Outline

Dimensions are shown in millimeters (inches)

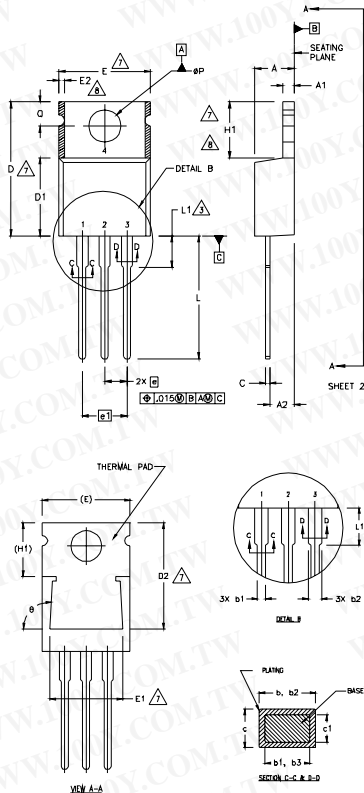

NOTES:

- 1 DIMENSIONING AND TOLERANCING PER ASME Y14.5 M- 1994.
- 2 DIMENSIONS ARE SHOWN IN INCHES (MILLIMETERS).
- 3 LEAD DIMENSION AND FINISH UNCONTROLLED IN L1.
- 4 DIMENSION D & E DO NOT INCLUDE MOLD FLASH. MOLD FLASH SHALL NOT EXCEED .005" (0.127) PER SIDE. THESE DIMENSIONS ARE MEASURED AT THE OUTERMOST EXTREMES OF THE PLASTIC BODY.
- 5 DIMENSION b1 & c1 APPLY TO BASE METAL ONLY.
- 6 CONTROLLING DIMENSION : INCHES.
- 7 THERMAL PAD CONTOUR OPTIONAL WITHIN DIMENSIONS E, H1, D2 & E1
- 8 DIMENSION E2 X H1 DEFINE A ZONE WHERE STAMPING AND SINGULATION IRREGULARITIES ARE ALLOWED.

LEAD ASSIGNMENT

- HEXFLET
- 1.- GATE
 - 2.- DRAIN
 - 3.- SOURCE

IRG/B/S/SL10B60KDPbF

- 1.- GATE
- 2.- COLLECTOR
- 3.- EMITTER

DIODES

- 1.- ANODE/OPEN
- 2.- CATHODE
- 3.- ANODE

SYMBOL	DIMENSIONS				NOTES
	MILLIMETERS		INCHES		
	MIN.	MAX.	MIN.	MAX.	
A	3.56	4.82	.140	.190	
A1	0.51	1.40	.020	.055	
A2	2.04	2.92	.080	.115	
b	0.38	1.01	.015	.040	
b1	0.38	0.96	.015	.038	5
b2	1.15	1.77	.045	.070	
b3	1.15	1.73	.045	.068	
c	0.36	0.61	.014	.024	
c1	0.36	0.56	.014	.022	5
D	14.22	16.51	.560	.650	4
D1	8.38	9.02	.330	.355	
D2	12.19	12.88	.480	.507	7
E	9.66	10.66	.380	.420	4,7
E1	8.38	8.89	.330	.350	7
e	2.54 BSC		.100 BSC		
e1	5.08		.200 BSC		
H1	5.85	6.55	.230	.270	7,8
L	12.70	14.73	.500	.580	
L1	-	6.35	-	.250	3
φP	3.54	4.08	.139	.161	
Q	2.54	3.42	.100	.135	
φ	90°-93°		90°-93°		

TO-220AB Part Marking Information

EXAMPLE: THIS IS AN IRF1010

LOT CODE 1789

ASSEMBLED ON WW 19, 1997
IN THE ASSEMBLY LINE "C"

Note: "P" in assembly line
position indicates "Lead-Free"

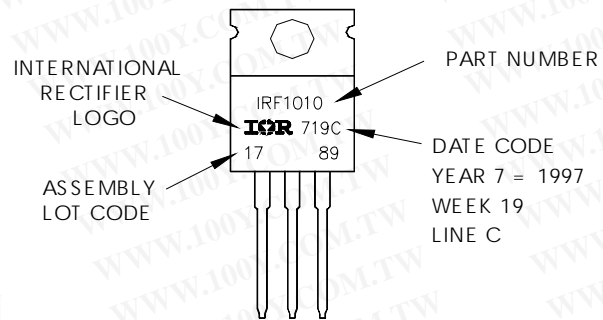

International
IR Rectifier

D²Pak Package Outline

Dimensions are shown in millimeters (inches)

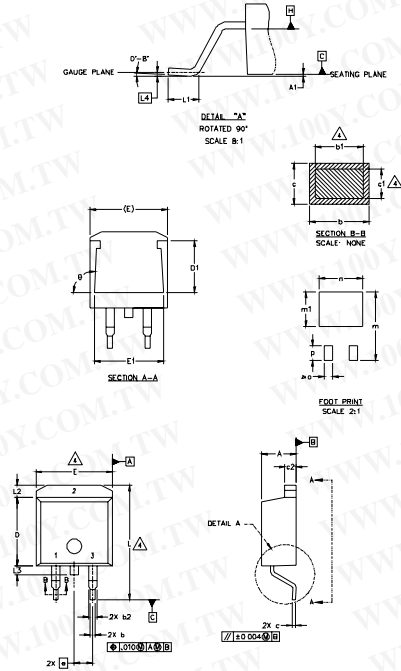

IRG/B/S/SL10B60KDPbF

SYMBOL	DIMENSIONS				NOTES
	MILLIMETERS		INCHES		
	MIN.	MAX.	MIN.	MAX.	
A	4.06	4.83	.160	.190	4
A1	0.127			.005	
b	0.51	0.99	.020	.039	
b1	0.51	0.89	.020	.035	
b2	1.14	1.40	.045	.055	4
c	0.43	0.63	.017	.025	
c1	0.38	0.74	.015	.029	3
c2	1.14	1.40	.045	.055	
D	8.51	9.65	.335	.380	3
D1	5.33		.210		
E	9.65	10.67	.380	.420	3
E1	6.22		.245		
e	2.54 BSC		.100 BSC		
L	14.61	15.88	.575	.625	
L1	1.78	2.79	.070	.110	
L2		1.65	.065		
L3	1.27	1.78	.050	.070	
L4	0.25 BSC		.010 BSC		
m	17.78		.700		
m1	8.89		.350		
n	11.43		.450		
o	2.08		.082		
p	3.81		.150		
theta	90°	93°	90°	93°	



LEAD ASSIGNMENTS

IGBTs, CoPACK

DIODES

HEXFEET

- 1.- GATE
- 2.- DRAIN
- 3.- SOURCE

- 1.- GATE
- 2.- COLLECTOR
- 3.- EMITTER

- 1.- ANODE *
- 2.- CATHODE
- 3.- ANODE

* PART DEPENDENT.

NOTES:

1. DIMENSIONING AND TOLERANCING PER ASME Y14.5M-1994
2. DIMENSIONS ARE SHOWN IN MILLIMETERS [INCHES].
3. DIMENSION D & E DO NOT INCLUDE MOLD FLASH. MOLD FLASH SHALL NOT EXCEED 0.127 [0.005"] PER SIDE. THESE DIMENSIONS ARE MEASURED AT THE OUTMOST EXTREMES OF THE PLASTIC BODY.
4. DIMENSION b1 AND c1 APPLY TO BASE METAL ONLY.
5. CONTROLLING DIMENSION: INCH.

D²Pak Part Marking Information

EXAMPLE: THIS IS AN IRF530S WITH
LOT CODE 8024
ASSEMBLED ON WW 02, 2000
IN THE ASSEMBLY LINE "L"

Note: "P" in assembly line
position indicates "Lead-Free"

OR

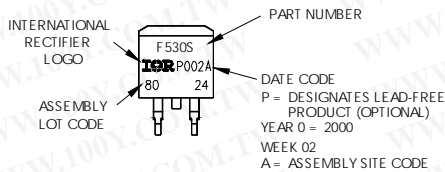
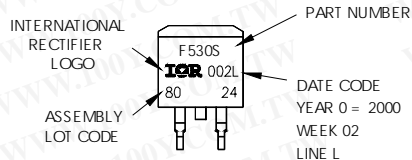

IRG/B/S/SL10B60KDPbF

International
IRF Rectifier

TO-262 Package Outline

Dimensions are shown in millimeters (inches)

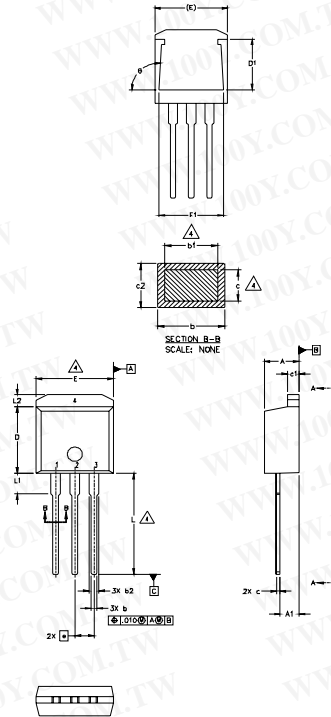

SYMBOL	DIMENSIONS				NOTES
	MILLIMETERS		INCHES		
	MIN.	MAX.	MIN.	MAX.	
A	4.06	4.83	.160	.190	
A1	2.03	2.92	.080	.115	
b	0.51	0.99	.020	.039	
b1	0.51	0.89	.020	.035	4
b2	1.14	1.40	.045	.055	
c	0.38	0.63	.015	.025	4
c1	1.14	1.40	.045	.055	
c2	0.43	.063	.017	.029	
D	8.51	9.65	.335	.380	3
D1	5.33		.210		
E	9.65	10.67	.380	.420	3
E1	6.22		.245		
e	2.54 BSC		.100 BSC		
L	13.46	14.09	.530	.555	
L1	3.56	3.71	.140	.146	
L2		1.65		.065	

LEAD ASSIGNMENTS

HEXFET

- 1. - GATE
- 2. - DRAIN
- 3. - SOURCE
- 4. - DRAIN

IGBT

- 1 - GATE
- 2 - COLLECTOR
- 3 - EMITTER

NOTES

1. DIMENSIONING AND TOLERANCING PER ASME Y14.5M-1994
2. DIMENSIONS ARE SHOWN IN MILLIMETERS [INCHES]
3. DIMENSION D & E DO NOT INCLUDE MOLD FLASH. MOLD FLASH SHALL NOT EXCEED 0.127 [005"] PER SIDE. THESE DIMENSIONS ARE MEASURED AT THE OUTMOST EXTREMES OF THE PLASTIC BODY.
4. DIMENSION b1 AND c1 APPLY TO BASE METAL ONLY.
5. CONTROLLING DIMENSION: INCH.

TO-262 Part Marking Information

EXAMPLE: THIS IS AN IRL3103L
LOT CODE 1789
ASSEMBLED ON WW 19, 1997
IN THE ASSEMBLY LINE "C"
Note: "P" in assembly line
position indicates "Lead-Free"

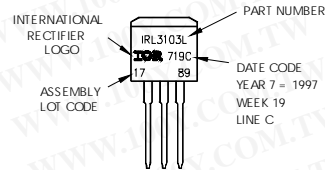

OR

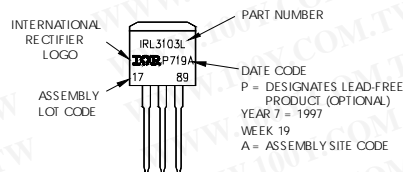

International
IR Rectifier

IRG/B/S/SL10B60KDPbF

D²Pak Tape & Reel Information

Dimensions are shown in millimeters (inches)

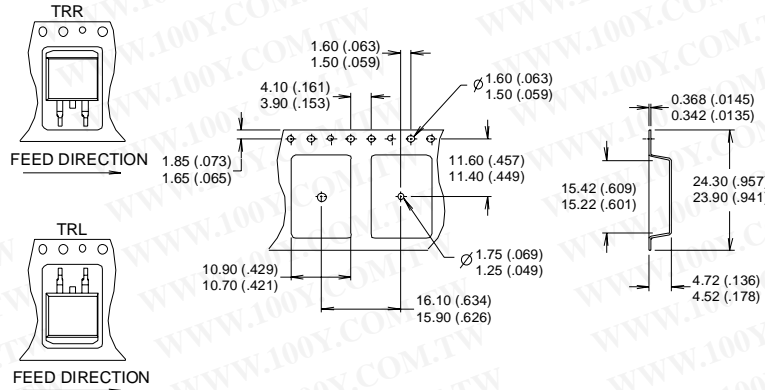

- NOTES:
1. CONFORMS TO EIA-418.
 2. CONTROLLING DIMENSION: MILLIMETER.
 3. DIMENSION MEASURED @ HUB.
 4. INCLUDES FLANGE DISTORTION @ OUTER EDGE.

Notes:

- ① This is only applied to TO-220AB package
- ② This is applied to D²Pak, when mounted on 1" square PCB (FR-4 or G-10 Material).
For recommended footprint and soldering techniques refer to application note #AN-994.
- ③ Energy losses include "tail" and diode reverse recovery.
- ④ $V_{CC} = 80\% (V_{CES})$, $V_{GE} = 20V$, $L = 100\mu H$, $R_G = 47\Omega$.

TO-220 package is not recommended for Surface Mount Application

Data and specifications subject to change without notice.
 This product has been designed and qualified for Industrial market.
 Qualification Standards can be found on IR's Web site.

International
IR Rectifier

IR WORLD HEADQUARTERS: 233 Kansas St., El Segundo, California 90245, USA Tel: (310) 252-7105
 TAC Fax: (310) 252-7903

Visit us at www.irf.com for sales contact information. 11/04