

NPT³ IGBT phaseleg in ISOPLUS i4-PAC™

勝特力材料 886-3-5753170
 勝特力电子(上海) 86-21-34970699
 勝特力电子(深圳) 86-755-83298787
[Http://www.100y.com.tw](http://www.100y.com.tw)

$I_{C25} = 50 \text{ A}$
 $V_{CES} = 1200 \text{ V}$
 $V_{CE(sat) \text{ typ.}} = 2.0 \text{ V}$

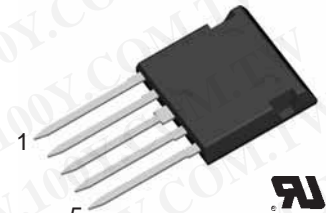
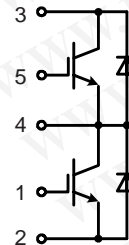

IGBTs

Symbol	Conditions	Maximum Ratings	
V_{CES}	$T_{VJ} = 25^{\circ}\text{C to } 150^{\circ}\text{C}$	1200	V
V_{GES}		± 20	V
I_{C25}	$T_C = 25^{\circ}\text{C}$	50	A
I_{C90}	$T_C = 90^{\circ}\text{C}$	32	A
I_{CM} V_{CEK}	$V_{GE} = \pm 15 \text{ V}; R_G = 39 \Omega; T_{VJ} = 125^{\circ}\text{C}$ RBSOA, Clamped inductive load; $L = 100 \mu\text{H}$	50	A
		V_{CES}	
t_{SC} (SCSOA)	$V_{CE} = 900\text{V}; V_{GE} = \pm 15 \text{ V}; R_G = 39 \Omega; T_{VJ} = 125^{\circ}\text{C}$ non-repetitive	10	μs
P_{tot}	$T_C = 25^{\circ}\text{C}$	200	W

Features

- NPT³ IGBT
 - low saturation voltage
 - positive temperature coefficient for easy paralleling
 - fast switching
 - short tail current for optimized performance in resonant circuits
- HiPerFRED™ diode
 - fast reverse recovery
 - low operating forward voltage
 - low leakage current
- ISOPLUS i4-PAC™ package
 - isolated back surface
 - enlarged creepage towards heatsink
 - application friendly pinout
 - low inductive current path
 - high reliability
 - industry standard outline
 - UL registered, E 72873

Symbol	Conditions	Characteristic Values ($T_{VJ} = 25^{\circ}\text{C}$, unless otherwise specified)		
		min.	typ.	max.
$V_{CE(sat)}$	$I_C = 30 \text{ A}; V_{GE} = 15 \text{ V}; T_{VJ} = 25^{\circ}\text{C}$ $T_{VJ} = 125^{\circ}\text{C}$	2.0	2.6	V
$V_{GE(th)}$	$I_C = 1 \text{ mA}; V_{GE} = V_{CE}$	4.5	6.5	V
I_{CES}	$V_{CE} = V_{CES}; V_{GE} = 0 \text{ V}; T_{VJ} = 25^{\circ}\text{C}$ $T_{VJ} = 125^{\circ}\text{C}$	0.4	0.4	mA mA
I_{GES}	$V_{CE} = 0 \text{ V}; V_{GE} = \pm 20 \text{ V}$		200	nA
$t_{d(on)}$ t_r $t_{d(off)}$ t_f	Inductive load, $T_{VJ} = 125^{\circ}\text{C}$ $V_{CE} = 600 \text{ V}; I_C = 30 \text{ A}$ $V_{GE} = \pm 15 \text{ V}; R_G = 39 \Omega$	85	50	ns
E_{on}		440	50	ns
E_{off}		4.6	2.2	mJ
		2.2		mJ
C_{ies}	$V_{CE} = 25 \text{ V}; V_{GE} = 0 \text{ V}; f = 1 \text{ MHz}$	2		nF
Q_{Gon}	$V_{CE} = 600 \text{ V}; V_{GE} = 15 \text{ V}; I_C = 30 \text{ A}$	250		nC
R_{thJC} R_{thJH}	with heatsink compound	1.2	0.6	KW KW

Applications

- single phaseleg
 - buck-boost chopper
- H bridge
 - power supplies
 - induction heating
 - four quadrant DC drives
 - controlled rectifier
- three phase bridge
 - AC drives
 - controlled rectifier

Diodes

Symbol	Conditions	Maximum Ratings	
I_{F25}	$T_C = 25^\circ\text{C}$	48	A
I_{F90}	$T_C = 90^\circ\text{C}$	25	A

Symbol	Conditions	Characteristic Values		
		min.	typ.	max.
V_F	$I_F = 30\text{ A}; T_{VJ} = 25^\circ\text{C}$ $T_{VJ} = 125^\circ\text{C}$	2.4	2.8	V
		1.8		V
I_{RM} t_{rr}	$I_F = 30\text{ A}; di/dt = -1100\text{ A}/\mu\text{s}; T_{VJ} = 125^\circ\text{C}$	51		A
		180		ns
$E_{rec(off)}$	$V_R = 600\text{ V}; V_{GE} = 0\text{ V}$	1.8		mJ
R_{thJC} R_{thJS}	(per diode)	1.6	1.3	K/W K/W

Component

Symbol	Conditions	Maximum Ratings	
T_{VJ}		-55...+150	$^\circ\text{C}$
T_{stg}		-55...+125	$^\circ\text{C}$
V_{ISOL}	$I_{ISOL} \leq 1\text{ mA}; 50/60\text{ Hz}$	2500	V~
F_C	mounting force with clip	20...120	N

Symbol	Conditions	Characteristic Values		
		min.	typ.	max.
d_S, d_A	pin - pin	1.7		mm
d_S, d_A	pin - backside metal	5.5		mm
Weight		9		g

Equivalent Circuits for Simulation

Conduction

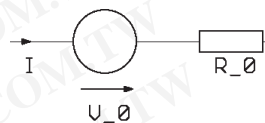

IGBT (typ. at $V_{GE} = 15\text{ V}; T_J = 125^\circ\text{C}$)
 $V_0 = 0.95\text{ V}; R_0 = 45\text{ m}\Omega$

Diode (typ. at $T_J = 125^\circ\text{C}$)
 $V_0 = 1.26\text{ V}; R_0 = 15\text{ m}\Omega$

Thermal Response

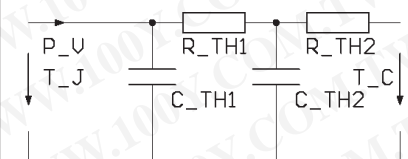

IGBT

$C_{th1} = 0.067\text{ J/K}; R_{th1} = 0.108\text{ K/W}$
 $C_{th2} = 0.175\text{ J/K}; R_{th2} = 0.491\text{ K/W}$

Diode

$C_{th1} = 0.039\text{ J/K}; R_{th1} = 0.337\text{ K/W}$
 $C_{th2} = 0.090\text{ J/K}; R_{th2} = 0.963\text{ K/W}$

Dimensions in mm (1 mm = 0.0394")

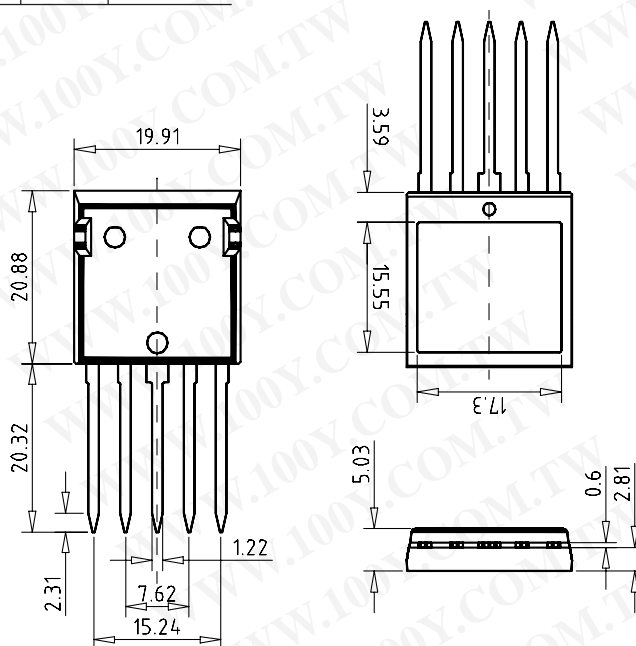

勝特力材料 886-3-5753170
 勝特力电子(上海) 86-21-34970699
 勝特力电子(深圳) 86-755-83298787
[Http://www.100y.com.tw](http://www.100y.com.tw)

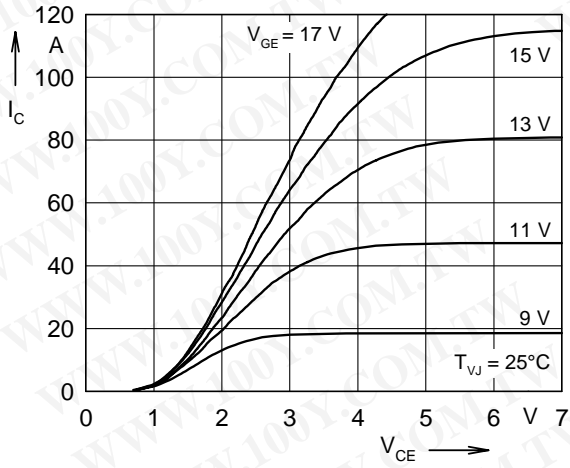

Fig. 1 Typ. output characteristics

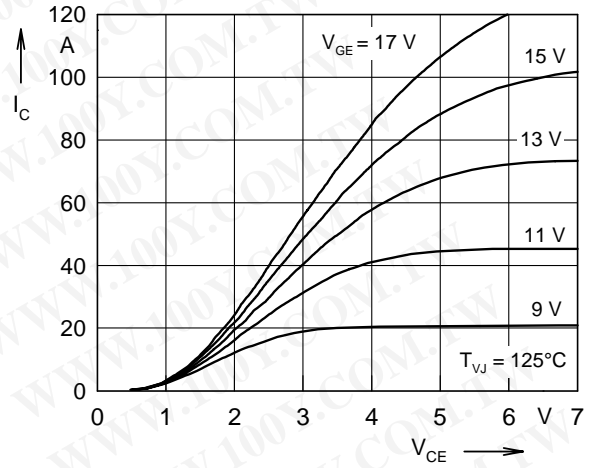

Fig. 2 Typ. output characteristics

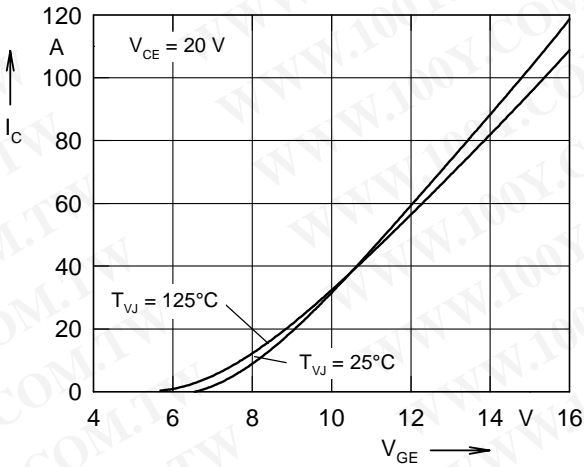

Fig. 3 Typ. transfer characteristics

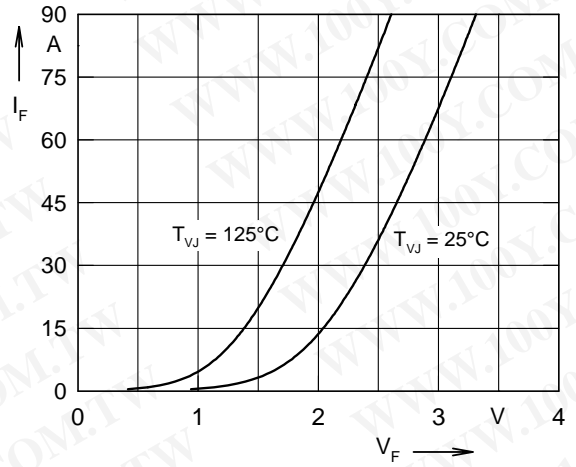

Fig. 4 Typ. forward characteristics of free wheeling diode

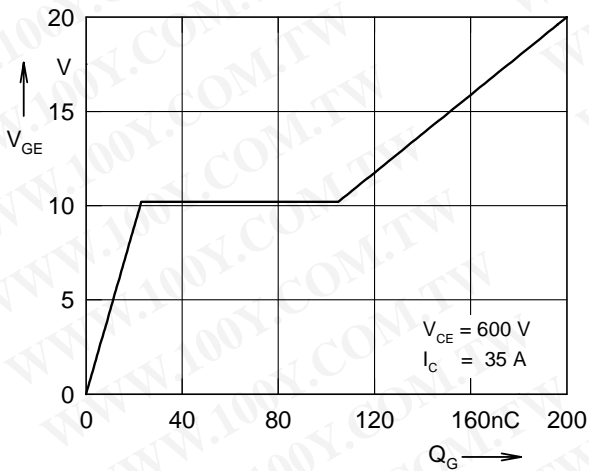

Fig. 5 Typ. turn on gate charge

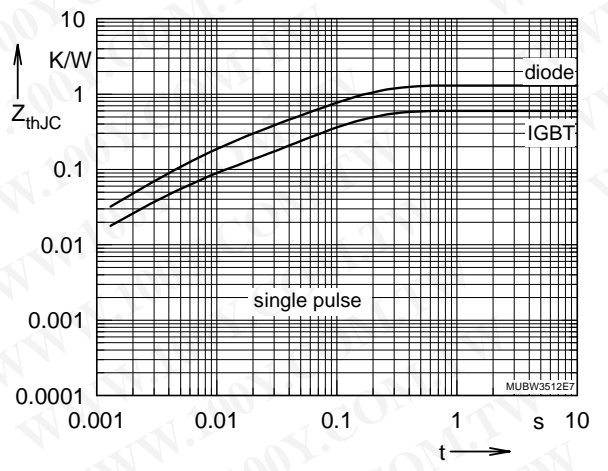

Fig. 6 Typ. transient thermal impedance

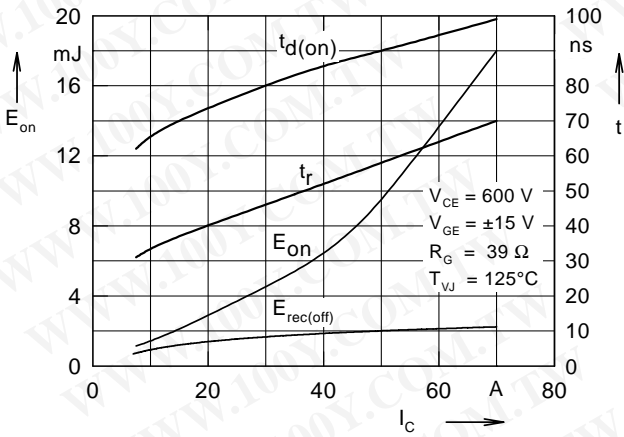

Fig. 7 Typ. turn on energy and switching times versus collector current

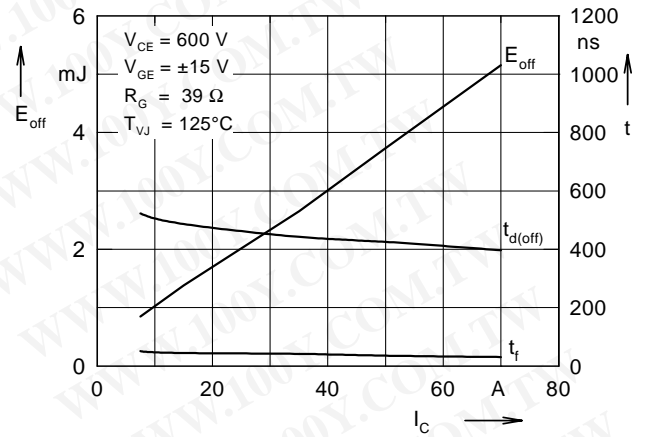

Fig. 8 Typ. turn off energy and switching times versus collector current

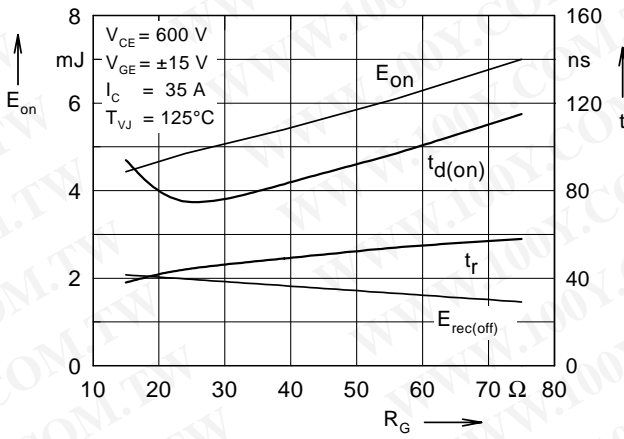

Fig. 9 Typ. turn on energy and switching times versus gate resistor

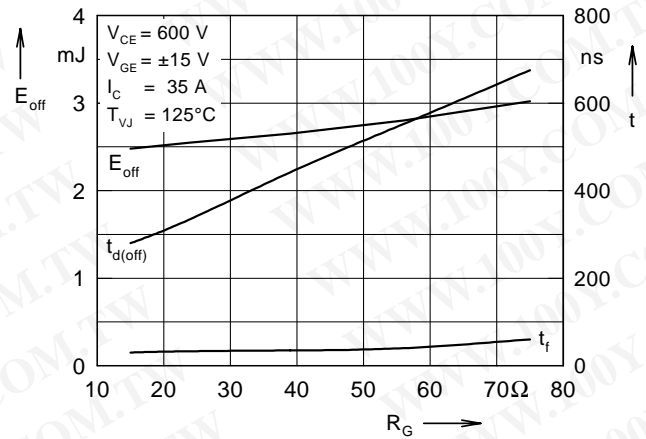

Fig. 10 Typ. turn off energy and switching times versus gate resistor

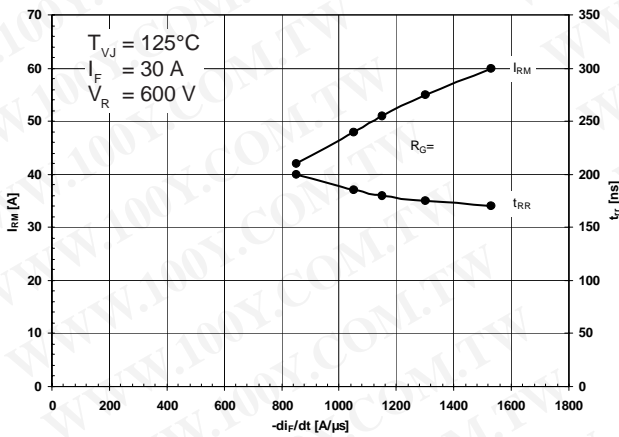

Fig. 11 Typ. turn off characteristics of free wheeling diode

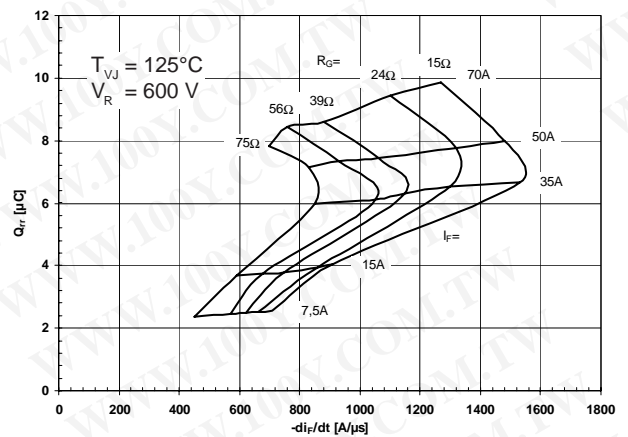

Fig. 12 Typ. turn off characteristics of free wheeling diode