



Micro Commercial Components

Micro Commercial Components
 20736 Marilla Street Chatsworth
 CA 91311
 Phone: (818) 701-4933
 Fax: (818) 701-4939

Features

- Lead Free Finish/RoHS Compliant ("P" Suffix designates RoHS Compliant. See ordering information)
- Epoxy meets UL 94 V-0 flammability rating
- Moisture Sensitivity Level 1
- Built-in bias resistors enable the configuration of an inverter circuit without connecting external input resistors
- The bias resistors consist of thin-film resistors with complete isolation to allow negative biasing of the input. They also have the advantage of almost completely eliminating parasitic effects.
- Only the on/off conditions need to be set for operation, making device design easy

Absolute maximum ratings @ 25°C

Symbol	Parameter	Min	Typ	Max	Unit
V_{CC}	Supply voltage	---	-50	---	V
V_{IN}	Input voltage	-40	---	10	V
I_O	Output current	---	-30	---	mA
$I_{C(MAX)}$	Output current	---	-100	---	mA
P_d	Power dissipation	---	150	---	mW
T_j	Junction temperature	---	150	---	°C
T_{stg}	Storage temperature	-55	---	150	°C

Electrical Characteristics @ 25°C

Symbol	Parameter	Min	Typ	Max	Unit
$V_{I(off)}$	Input voltage ($V_{CC}=-5V, I_O=-100\mu A$)	---	---	-0.5	V
$V_{I(on)}$	Input voltage ($V_O=0.3V, I_O=2mA$)	-3.0	---	---	V
$V_{O(on)}$	Output voltage ($I_O/I_I=-10mA/-0.5mA$)	---	---	-0.3	V
I_I	Input current ($V_I=-5V$)	---	---	-0.18	mA
$I_{O(off)}$	Output current ($V_{CC}=-50V, V_I=0$)	---	---	-0.5	μA
G_1	DC current gain ($V_O=-5V, I_O=-5mA$)	68	---	---	
R_1	Input resistance	32.9	47	61.1	$K\Omega$
R_2/R_1	Resistance ratio	0.8	1.0	1.2	
f_T	Transition frequency ($V_{CE}=-10V, I_E=5mA, f=100MHz$)	---	250	---	MHz

Equivalent circuit

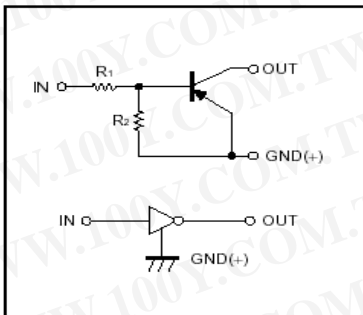

*Marking: 16

DTA144EE

PNP Digital Transistors

SOT-523

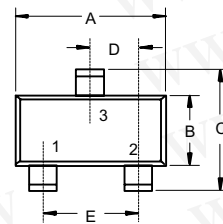

1. IN
 2. GND
 3. OUT

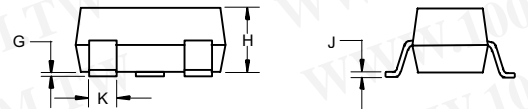

DIM	DIMENSIONS				NOTE
	INCHES		MM		
A	.059	.067	1.50	1.70	
B	.030	.033	0.75	0.85	
C	.057	.069	1.45	1.75	
D	.020 Nominal		0.50 Nominal		
E	.035	.043	0.90	1.10	
G	.000	.004	.000	.100	
H	.028	.031	.70	0.80	
J	.004	.008	.100	.200	
K	.010	.014	.25	.35	

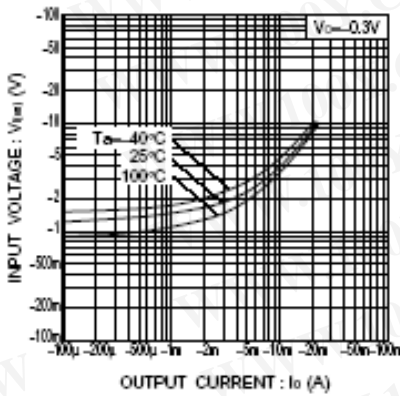

Fig.1 Input voltage vs. output current (ON characteristics)

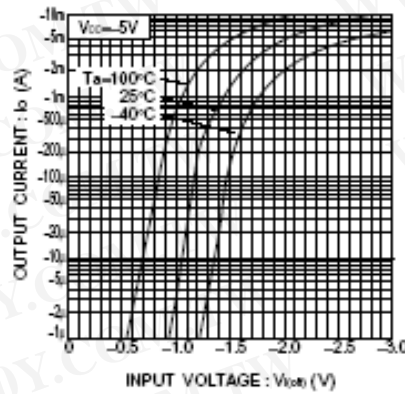

Fig.2 Output current vs. input voltage (OFF characteristics)

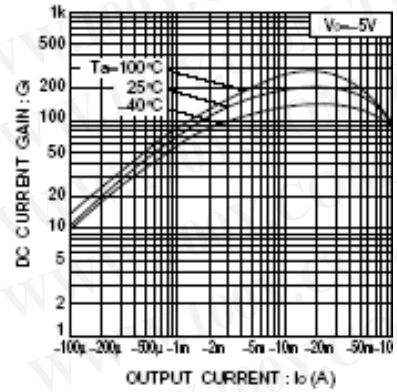

Fig.3 DC current gain vs. output current

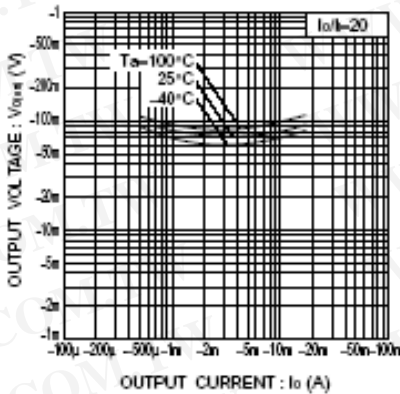

Fig.4 Output voltage vs. output current

勝特力材料 886-3-5753170
 勝特力电子(上海) 86-21-34970699
 勝特力电子(深圳) 86-755-83298787
[Http://www.100y.com.tw](http://www.100y.com.tw)

Ordering Information :

Device	Packing
Part Number-TP	Tape&Reel; 3Kpcs/Reel

*****IMPORTANT NOTICE*****

Micro Commercial Components Corp. reserves the right to make changes without further notice to any product herein to make corrections, modifications, enhancements, improvements, or other changes. **Micro Commercial Components Corp.** does not assume any liability arising out of the application or use of any product described herein; neither does it convey any license under its patent rights, nor the rights of others. The user of products in such applications shall assume all risks of such use and will agree to hold **Micro Commercial Components Corp.** and all the companies whose products are represented on our website, harmless against all damages.

*****LIFE SUPPORT*****

MCC's products are not authorized for use as critical components in life support devices or systems without the express written approval of Micro Commercial Components Corporation.

*****CUSTOMER AWARENESS*****

Counterfeiting of semiconductor parts is a growing problem in the industry. Micro Commercial Components (MCC) is taking strong measures to protect ourselves and our customers from the proliferation of counterfeit parts. MCC strongly encourages customers to purchase MCC parts either directly from MCC or from Authorized MCC Distributors who are listed by country on our web page cited below. Products customers buy either from MCC directly or from Authorized MCC Distributors are genuine parts, have full traceability, meet MCC's quality standards for handling and storage. **MCC will not provide any warranty coverage or other assistance for parts bought from Unauthorized Sources.** MCC is committed to combat this global problem and encourage our customers to do their part in stopping this practice by buying direct or from authorized distributors.