

SWITCHMODE SERIES NPN POWER TRANSISTORS

... designed for use in high-voltage, high-speed, power switching in inductive circuit, they are particularly suited for 115 and 220 V switchmode applications such as switching regulator's, inverters, DC -DC and converter

FEATURES:

*Collector-Emitter Sustaining Voltage-

$$V_{CE(SUS)} = 400 \text{ V (Min)}$$

* Collector-Emitter Saturation Voltage -

$$V_{CE(sat)} = 1.0 \text{ V (Max.) @ } I_C = 4.0 \text{ A, } I_B = 0.8 \text{ A}$$

* Switching Time - $t_f = 1.0 \text{ us (Max.) @ } I_C = 5.0 \text{ A}$

NPN
2SC3039

7.0 AMPERE
SILICON POWER
TRANSISTORS
400 VOLTS
50 WATTS

MAXIMUM RATINGS

Characteristic	Symbol	2SC3039	Unit
Collector-Emitter Voltage	V_{CEO}	400	V
Collector-Base Voltage	V_{CBO}	500	V
Emitter-Base Voltage	V_{EBO}	7.0	V
Collector Current - Continuous - Peak	I_C I_{CM}	7.0 14	A
Base current	I_B	3.0	A
Total Power Dissipation @ $T_C = 25^\circ\text{C}$ Derate above 25°C	P_D	50 0.4	W W/ $^\circ\text{C}$
Operating and Storage Junction Temperature Range	T_J, T_{STG}	-55 to +150	$^\circ\text{C}$

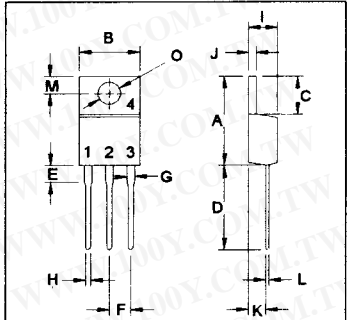
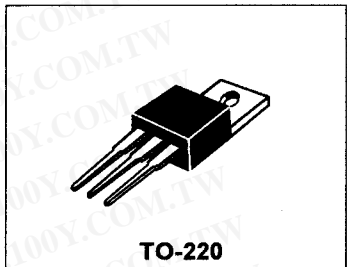

PIN 1.BASE
2.COLLECTOR
3.EMITTER
4.COLLECTOR(CASE)

THERMAL CHARACTERISTICS

Characteristic	Symbol	Max	Unit
Thermal Resistance Junction to Case	$R_{\theta jc}$	2.5	$^\circ\text{C/W}$

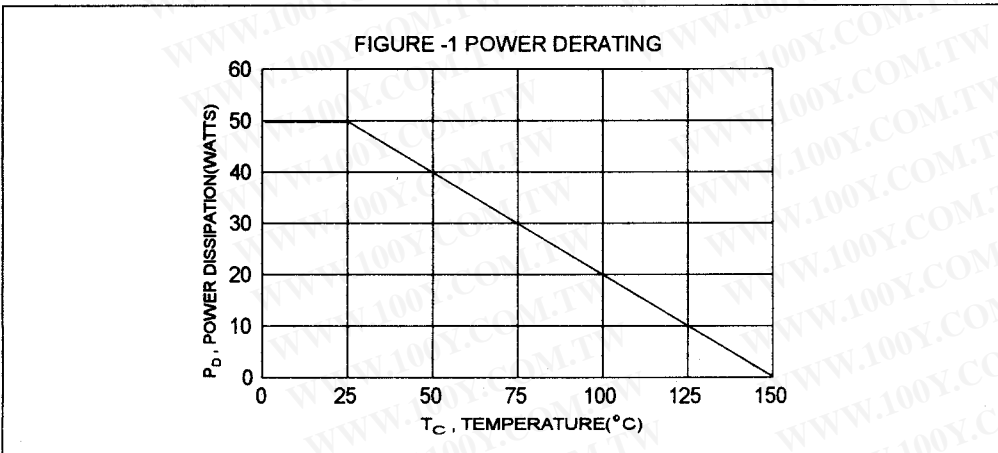

DIM	MILLIMETERS	
	MIN	MAX
A	14.68	15.31
B	9.78	10.42
C	5.01	6.52
D	13.06	14.62
E	3.57	4.07
F	2.42	3.66
G	1.12	1.36
H	0.72	0.96
I	4.22	4.98
J	1.14	1.38
K	2.20	2.97
L	0.33	0.55
M	2.48	2.98
O	3.70	3.90

勝特力材料 886-3-5753170
勝特力电子(上海) 86-21-34970699
勝特力电子(深圳) 86-755-83298787
[Http://www.100y.com.tw](http://www.100y.com.tw)

ELECTRICAL CHARACTERISTICS (T_c = 25°C unless otherwise noted)

Characteristic	Symbol	Min	Max	Unit
----------------	--------	-----	-----	------

OFF CHARACTERISTICS

Collector-Emitter Sustaining Voltage (I _C = 7.0 A, I _{B1} = 1.4 A, L = 50 μH)	V _{CEO(sus)}	400		V
Collector-Base Breakdown Voltage (I _C = 1.0 mA, I _E = 0)	V _{(BR)CBO}	500		V
Collector-Emitter Breakdown Voltage (I _C = 5.0 mA, I _B = 0)	V _{(BR)CEO}	400		V
Emitter-Base Breakdown Voltage (I _E = 1.0 mA, I _C = 0)	V _{(BR)EBO}	7.0		V
Collector Cutoff Current (V _{CB} = 400 V, I _E = 0)	I _{CBO}		10	μA
Emitter Cutoff Current (V _{EB} = 5.0 V, I _C = 0)	I _{EBO}		10	μA

ON CHARACTERISTICS (1)

DC Current Gain (I _C = 0.8 A, V _{CE} = 5.0 V) (I _C = 4.0 A, V _{CE} = 5.0 V)	hFE(2) hFE	15 8.0	50	
Collector-Emitter Saturation Voltage (I _C = 4.0 A, I _B = 800 mA)	V _{CE(sat)}		1.0	V
Base-Emitter Saturation Voltage (I _C = 4.0 A, I _B = 800 mA)	V _{BE(sat)}		1.5	V

SWITCHING CHARACTERISTICS

On Time	V _{CC} = 200V, I _C = 5.0A I _{B1} = -I _{B2} = 1.0A R _L = 40 ohm	t _{on}	1.0	us
Storage Time		t _s	2.5	us
Fall Time		t _f	1.0	us

(1) Pulse Test: Pulse Width = 300 us, Duty Cycle ≤ 2.0%,
* hFE(2) Classification: L : 15 — 30 ; M : 20 — 40 ; N : 30 — 50

SAFE OPERATING AREA

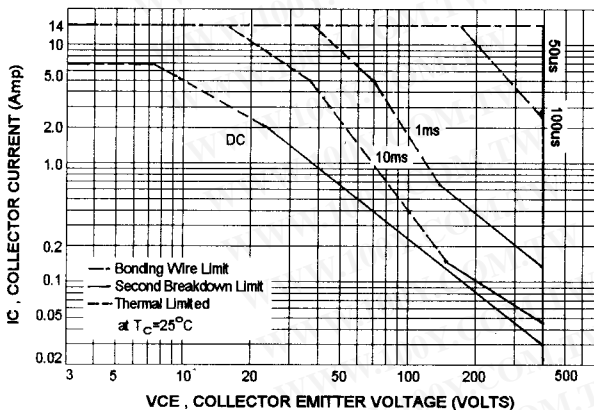

REVERSE BIASE SAFE OPERATING AREA

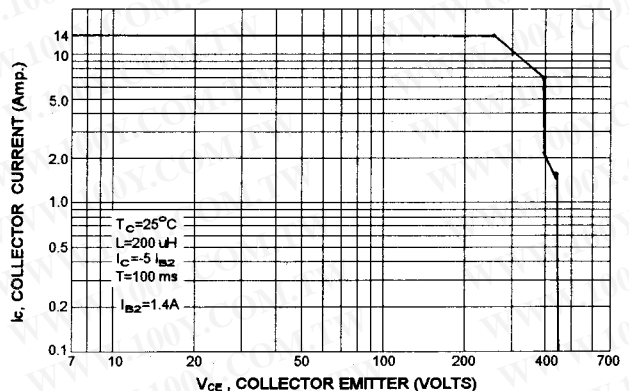

勝特力材料 886-3-5753170
 勝特力电子(上海) 86-21-34970699
 勝特力电子(深圳) 86-755-83298787
[Http://www.100y.com.tw](http://www.100y.com.tw)

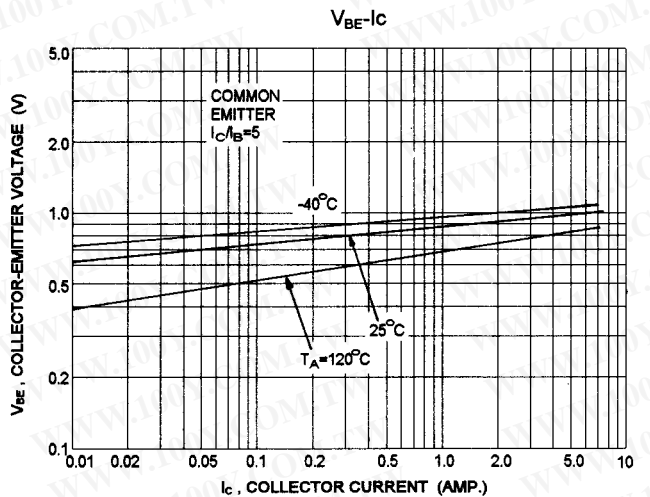
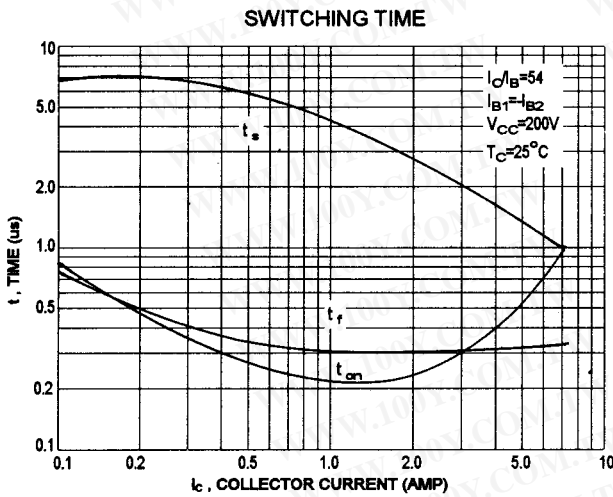
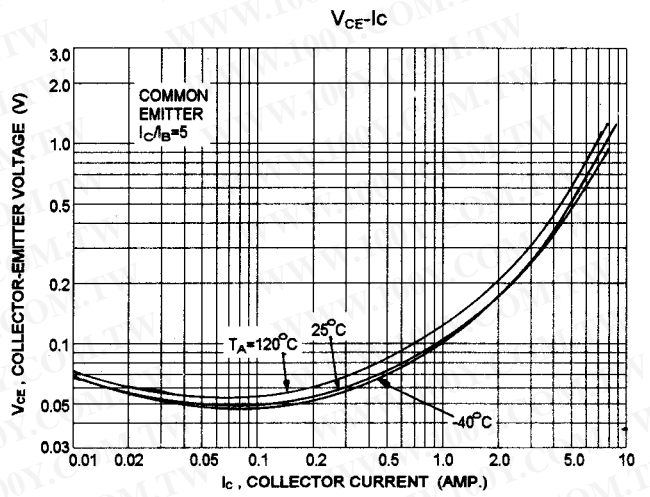
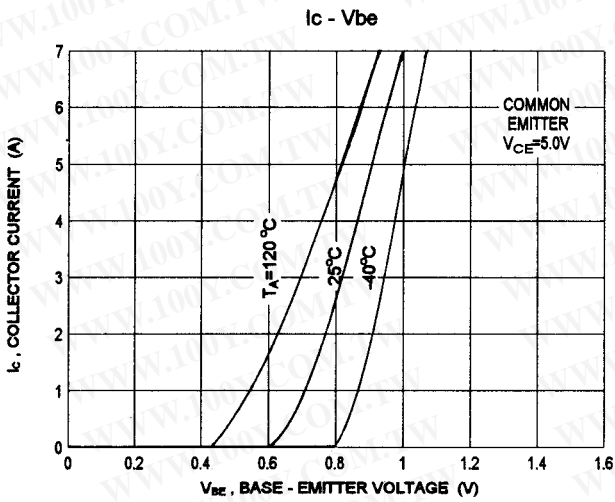
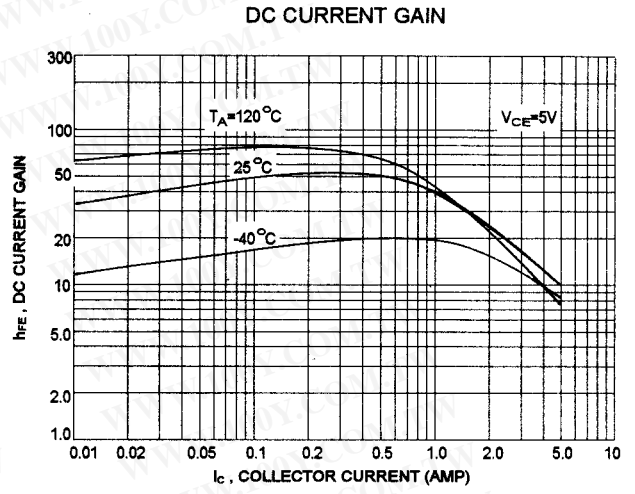
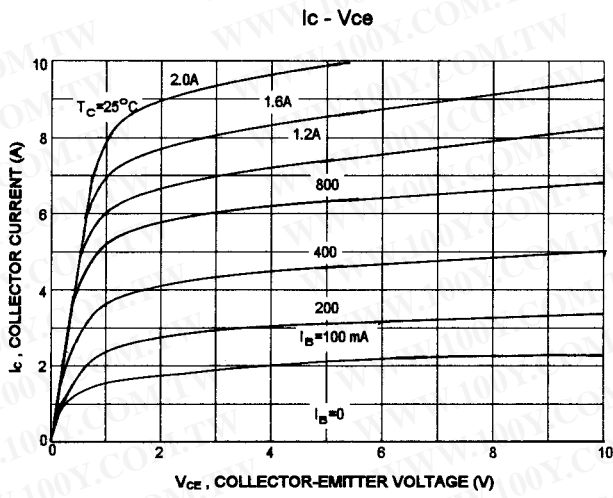

勝特力材料 886-3-5753170
 勝特力电子(上海) 86-21-34970699
 勝特力电子(深圳) 86-755-83298787
[Http://www.100y.com.tw](http://www.100y.com.tw)