

DARLINGTON COMPLEMENTARY SILICON POWER TRANSISTORS

...designed for general-purpose amplifier and low speed switching applications

FEATURES:

- * Collector-Emitter Sustaining Voltage-
 $V_{CE(SUS)}$ = 45 V (Min) - BDX53, BDX54
 = 60 V (Min) - BDX53A, BDX54A
 = 80 V (Min) - BDX53B, BDX54B
 = 100 V (Min) - BDX53C, BDX54C
- * Monolithic Construction with Built-in Base-Emitter Shunt Resistor

NPN	PNP
BDX53	BDX54
BDX53A	BDX54A
BDX53B	BDX54B
BDX53C	BDX54C

8 AMPERE
 DARLINGTON
 COMPLEMENTARY SILICON
 POWER TRANSISTORS
 45-100 VOLTS
 60 WATTS

MAXIMUM RATINGS

Characteristic	Symbol	BDX53 BDX54	BDX53A BDX54A	BDX53B BDX54B	BDX53C BDX54C	Unit
Collector-Emitter Voltage	V_{CEO}	45	60	80	100	V
Collector-Base Voltage	V_{CBO}	45	60	80	100	V
Emitter-Base Voltage	V_{EBO}	5.0				V
Collector Current - Continuous	I_C	8.0				A
Peak	I_{CM}	12				
Base Current	I_B	0.2				A
Total Power Dissipation @ $T_C = 25^\circ C$ Derate above $25^\circ C$	P_D	60 0.48				W W/ $^\circ C$
Operating and Storage Junction Temperature Range	T_J, T_{STG}	-65 to +150				$^\circ C$

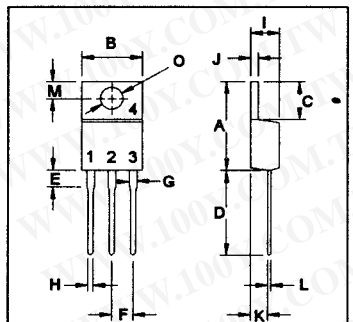
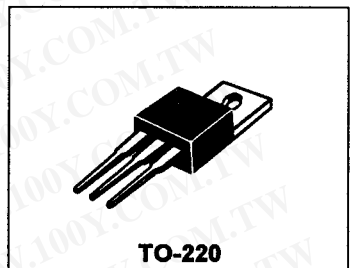

PIN 1.BASE
 2.COLLECTOR
 3.EMITTER
 4.COLLECTOR(CASE)

THERMAL CHARACTERISTICS

Characteristic	Symbol	Max	Unit
Thermal Resistance Junction to Case	$R_{\theta jc}$	2.08	$^\circ C/W$

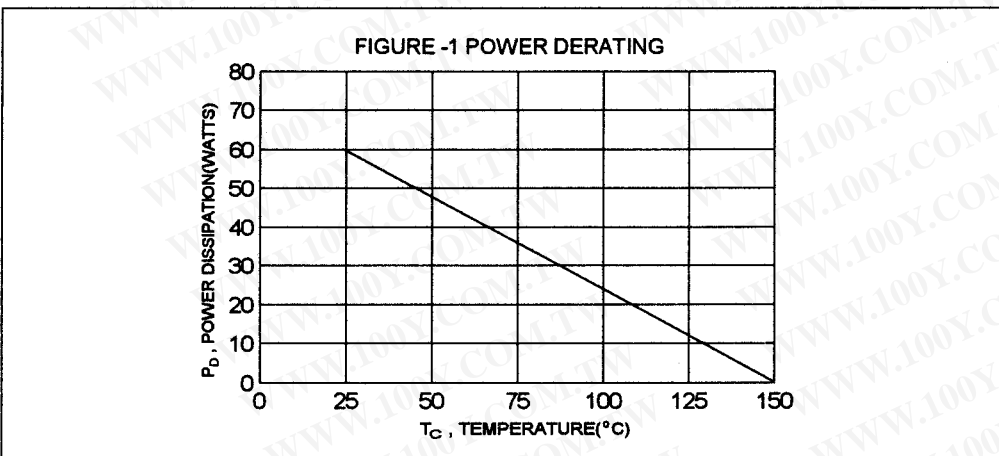

DIM	MILLIMETERS	
	MIN	MAX
A	14.68	15.31
B	9.78	10.42
C	5.01	6.52
D	13.06	14.62
E	3.57	4.07
F	2.42	3.66
G	1.12	1.36
H	0.72	0.96
I	4.22	4.98
J	1.14	1.38
K	2.20	2.97
L	0.33	0.55
M	2.48	2.98
O	3.70	3.90

ELECTRICAL CHARACTERISTICS ($T_c = 25^\circ\text{C}$ unless otherwise noted)

Characteristic	Symbol	Min	Max	Unit
----------------	--------	-----	-----	------

OFF CHARACTERISTICS

Collector-Emitter Sustaining Voltage(1) ($I_c = 100\text{ mA}$, $I_B = 0$)	BDX53, BDX54 BDX53A, BDX54A BDX53B, BDX54B BDX53C, BDX54C	$V_{CE(sus)}$	45 60 80 100	V
Collector Cutoff Current ($V_{CE} = 22\text{ V}$, $I_B = 0$) ($V_{CE} = 30\text{ V}$, $I_B = 0$) ($V_{CE} = 40\text{ V}$, $I_B = 0$) ($V_{CE} = 50\text{ V}$, $I_B = 0$)	BDX53, BDX54 BDX53A, BDX54A BDX53B, BDX54B BDX53C, BDX54C	I_{CEO}		0.5 0.5 0.5 0.5 mA
Collector-Base Cutoff Current ($V_{CB} = \text{Rated } V_{CB}$, $I_E = 0$)		I_{CBO}		200 uA
Emitter-Base Cutoff Current ($V_{EB} = 5.0\text{ V}$, $I_C = 0$)		I_{EBO}		2.0 mA

ON CHARACTERISTICS (1)

DC Current Gain ($I_C = 3.0\text{ A}$, $V_{CE} = 3.0\text{ V}$)		hFE		750
Collector-Emitter Saturation Voltag ($I_C = 3.0\text{ A}$, $I_B = 12\text{ mA}$)		$V_{CE(sat)}$		2.0 V
Base-Emitter Saturation Voltage ($I_C = 3.0\text{ A}$, $I_B = 12\text{ mA}$)		$V_{BE(sat)}$		2.5 V
Diode Forward-Voltage ($I_F = 3.0\text{ A}$)		V_F		2.5 V

(1) Pulse Test: Pulse Width = 300 us, Duty Cycle $\leq 2.0\%$

INTERNAL SCHEMATIC DIAGRAM

BDX53 Series NPN

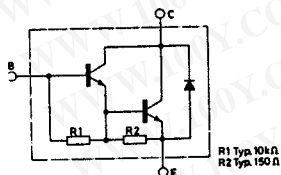

BDX54 Series PNP

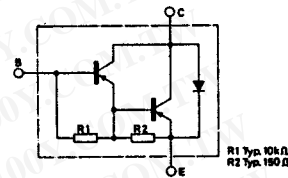

NPN BDX53,A,B,C

COLLECTOR SATURATION REGION

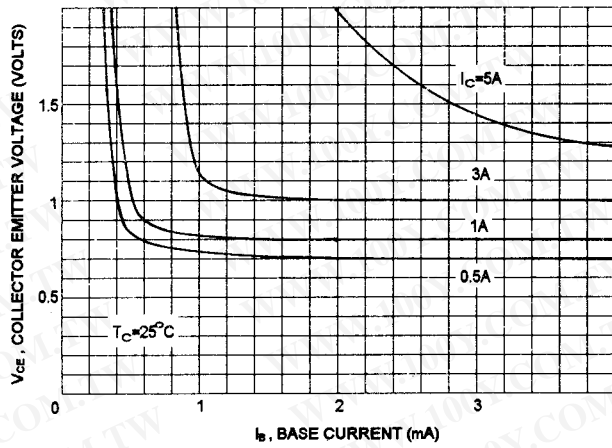

PNP BDX54,A,B,C

COLLECTOR SATURATION REGION

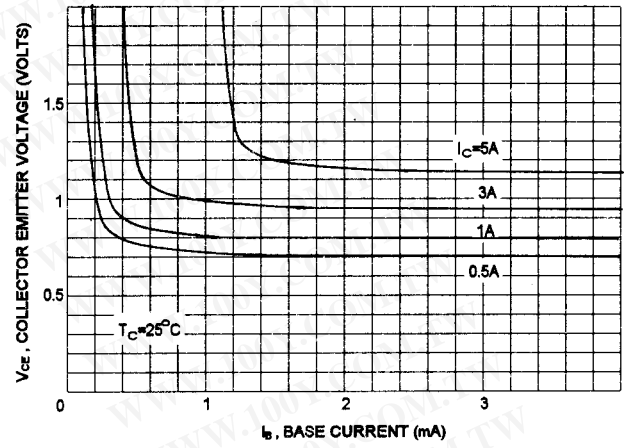

SWITCHING TIME

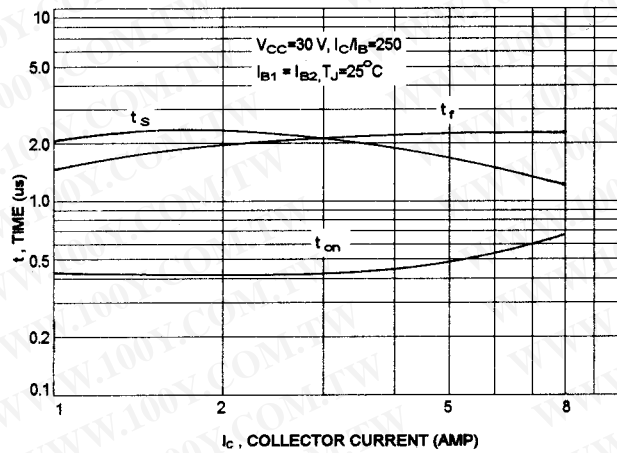

SWITCHING TIME

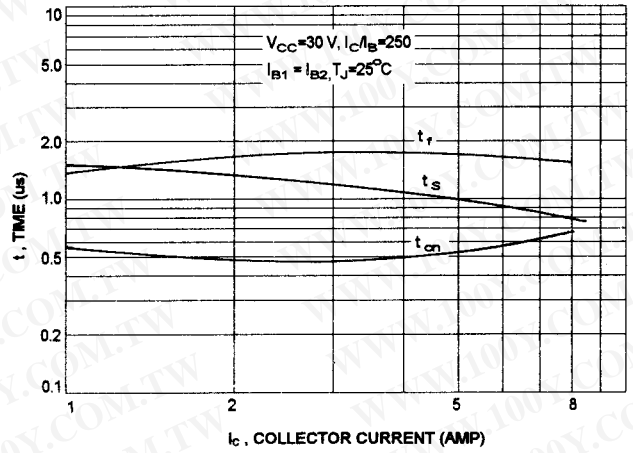

SAFE OPERATING AREA

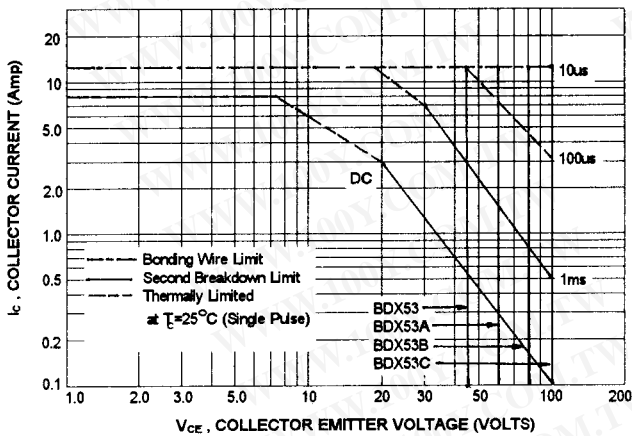

SAFE OPERATING AREA

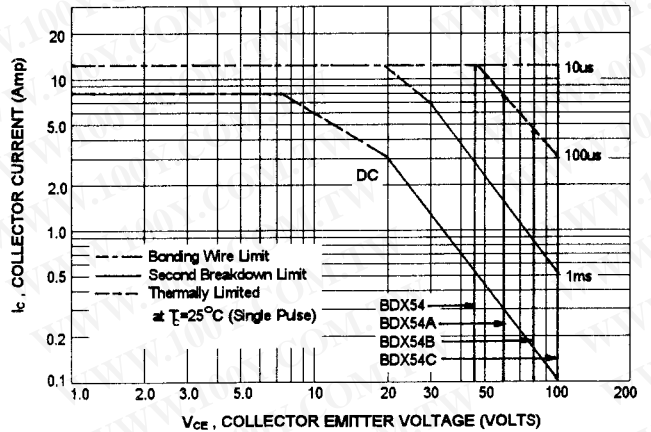

DC CURRENT GAIN

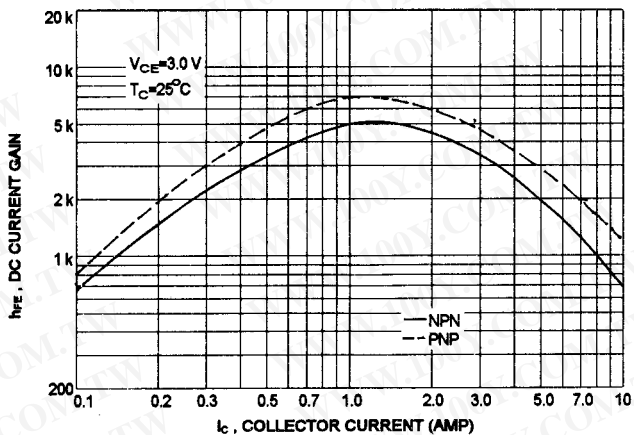

$I_C - V_{BE}$

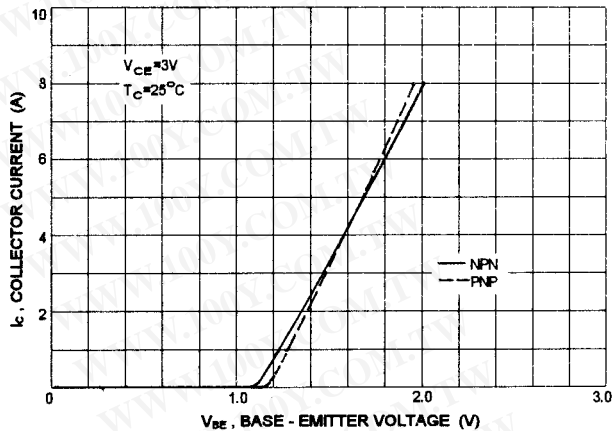

SMALL SIGNAL CURRENT GAIN

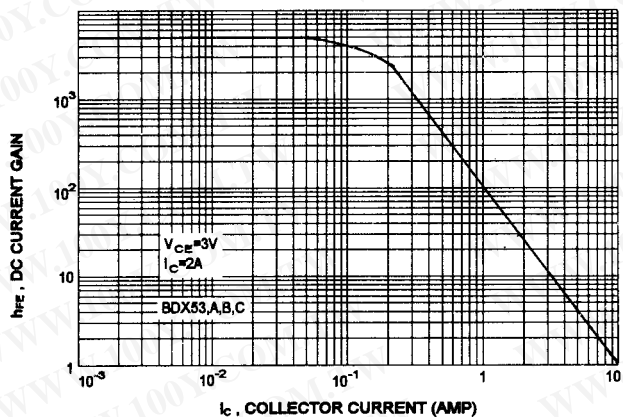

SMALL SIGNAL CURRENT GAIN

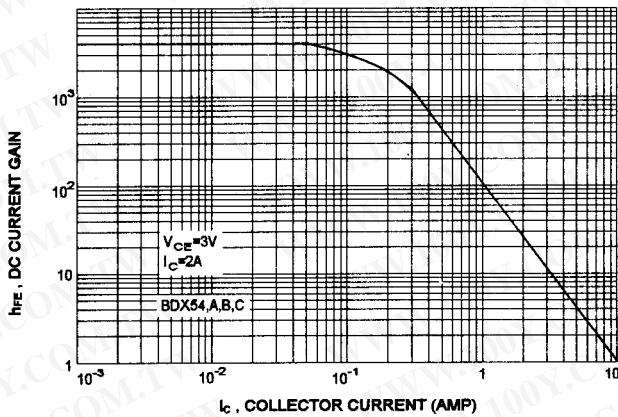

$V_{CE(sat)} - I_C$

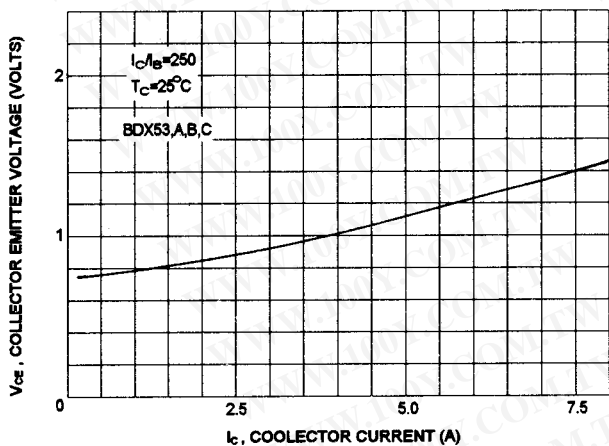

$V_{CE(sat)} - I_C$

