

NUP2105L, SZNUP2105L

Dual Line CAN Bus Protector

The SZ/NUP2105L has been designed to protect the CAN transceiver in high-speed and fault tolerant networks from ESD and other harmful transient voltage events. This device provides bidirectional protection for each data line with a single compact SOT-23 package, giving the system designer a low cost option for improving system reliability and meeting stringent EMI requirements.

Features

- 350 W Peak Power Dissipation per Line (8 x 20 μ sec Waveform)
- Low Reverse Leakage Current (< 100 nA)
- Low Capacitance High-Speed CAN Data Rates
- IEC Compatibility:
 - IEC 61000-4-2 (ESD): Level 4
 - IEC 61000-4-4 (EFT): 40 A - 5/50 ns
 - IEC 61000-4-5 (Lighting) 8.0 A (8/20 μ s)
- ISO 7637-1, Nonrepetitive EMI Surge Pulse 2, 9.5 A (1 x 50 μ s)
- ISO 7637-3, Repetitive Electrical Fast Transient (EFT) EMI Surge Pulses, 50 A (5 x 50 ns)
- Flammability Rating UL 94 V-0
- AEC-Q101 Qualified and PPAP Capable
- SZ Prefix for Automotive and Other Applications Requiring Unique Site and Control Change Requirements
- Pb-Free Packages are Available*

Applications

- Industrial Control Networks
 - ◆ Smart Distribution Systems (SDS[®])
 - ◆ DeviceNet[™]
- Automotive Networks
 - ◆ Low and High-Speed CAN
 - ◆ Fault Tolerant CAN

勝特力材料 886-3-5753170
勝特力电子(上海) 86-21-34970699
勝特力电子(深圳) 86-755-83298787
[Http://www.100y.com.tw](http://www.100y.com.tw)



ON Semiconductor[®]

<http://onsemi.com>

SOT-23
DUAL BIDIRECTIONAL
VOLTAGE SUPPRESSOR
350 W PEAK POWER

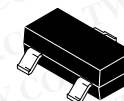

SOT-23
CASE 318
STYLE 27

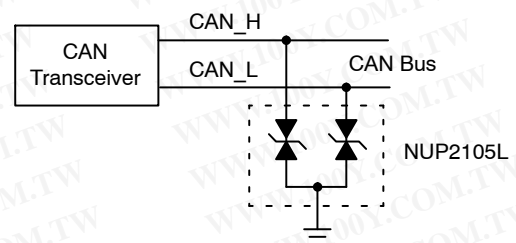
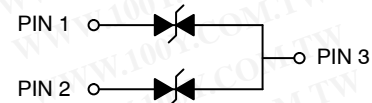

MARKING DIAGRAM

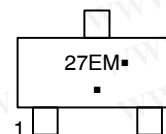

27E = Device Code
M = Date Code
▪ = Pb-Free Package

(Note: Microdot may be in either location)

ORDERING INFORMATION

See detailed ordering and shipping information in the package dimensions section on page 2 of this data sheet.

*For additional information on our Pb-Free strategy and soldering details, please download the ON Semiconductor Soldering and Mounting Techniques Reference Manual, SOLDERRM/D.

NUP2105L, SZNUP2105L

MAXIMUM RATINGS ($T_J = 25^\circ\text{C}$, unless otherwise specified)

Symbol	Rating	Value	Unit
PPK	Peak Power Dissipation 8 x 20 μs Double Exponential Waveform (Note 1)	350	W
T_J	Operating Junction Temperature Range	-55 to 150	$^\circ\text{C}$
T_J	Storage Temperature Range	-55 to 150	$^\circ\text{C}$
T_L	Lead Solder Temperature (10 s)	260	$^\circ\text{C}$
ESD	Human Body model (HBM) Machine Model (MM) IEC 61000-4-2 Specification (Contact)	16 400 30	kV V kV

Maximum ratings are those values beyond which device damage can occur. Maximum ratings applied to the device are individual stress limit values (not normal operating conditions) and are not valid simultaneously. If these limits are exceeded, device functional operation is not implied, damage may occur and reliability may be affected.

1. Non-repetitive current pulse per Figure 1.

ELECTRICAL CHARACTERISTICS ($T_J = 25^\circ\text{C}$, unless otherwise specified)

Symbol	Parameter	Test Conditions	Min	Typ	Max	Unit
V_{RWM}	Reverse Working Voltage	(Note 2)	24	-	-	V
V_{BR}	Breakdown Voltage	$I_T = 1\text{ mA}$ (Note 3)	26.2	-	32	V
I_R	Reverse Leakage Current	$V_{RWM} = 24\text{ V}$	-	15	100	nA
V_C	Clamping Voltage	$I_{PP} = 5\text{ A}$ (8 x 20 μs Waveform) (Note 4)	-	-	40	V
V_C	Clamping Voltage	$I_{PP} = 8\text{ A}$ (8 x 20 μs Waveform) (Note 4)	-	-	44	V
I_{PP}	Maximum Peak Pulse Current	8 x 20 μs Waveform (Note 4)	-	-	8.0	A
CJ	Capacitance	$V_R = 0\text{ V}$, $f = 1\text{ MHz}$ (Line to GND)	-	-	30	pF

2. TVS devices are normally selected according to the working peak reverse voltage (V_{RWM}), which should be equal or greater than the DC or continuous peak operating voltage level.
3. V_{BR} is measured at pulse test current I_T .
4. Pulse waveform per Figure 1.

ORDERING INFORMATION

Device	Package	Shipping [†]
NUP2105LT1	SOT-23	3,000 / Tape & Reel
NUP2105LT1G	SOT-23 (Pb-Free)	3,000 / Tape & Reel
SZNUP2105LT1G	SOT-23 (Pb-Free)	3,000 / Tape & Reel
NUP2105LT3	SOT-23	10,000 / Tape & Reel
NUP2105LT3G	SOT-23 (Pb-Free)	10,000 / Tape & Reel
SZNUP2105LT3G	SOT-23 (Pb-Free)	10,000 / Tape & Reel

[†]For information on tape and reel specifications, including part orientation and tape sizes, please refer to our Tape and Reel Packaging Specifications Brochure, BRD8011/D.

NUP2105L, SZNUP2105L

TYPICAL PERFORMANCE CURVES

($T_J = 25^\circ\text{C}$ unless otherwise noted)

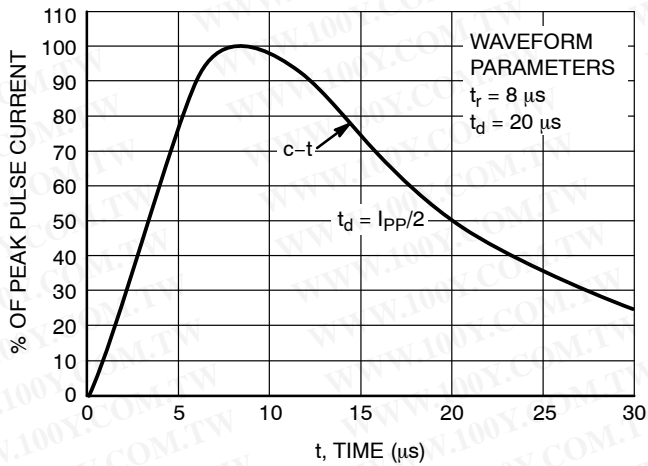

Figure 1. Pulse Waveform, $8 \times 20 \mu\text{s}$

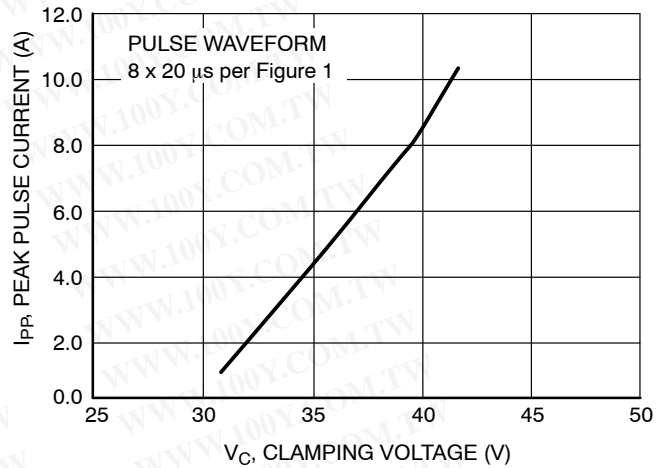

Figure 2. Clamping Voltage vs Peak Pulse Current

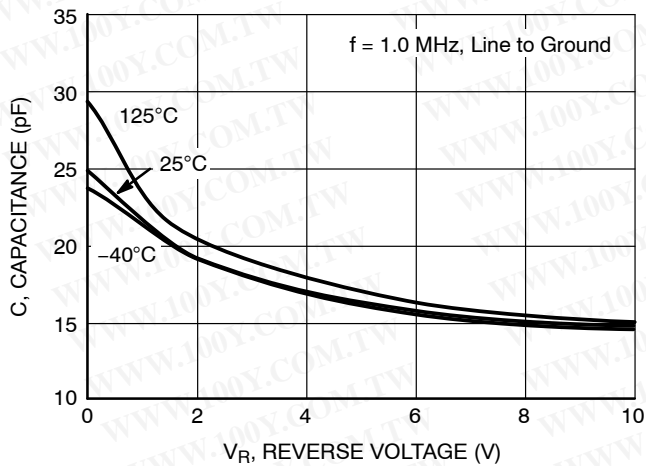

Figure 3. Typical Junction Capacitance vs Reverse Voltage

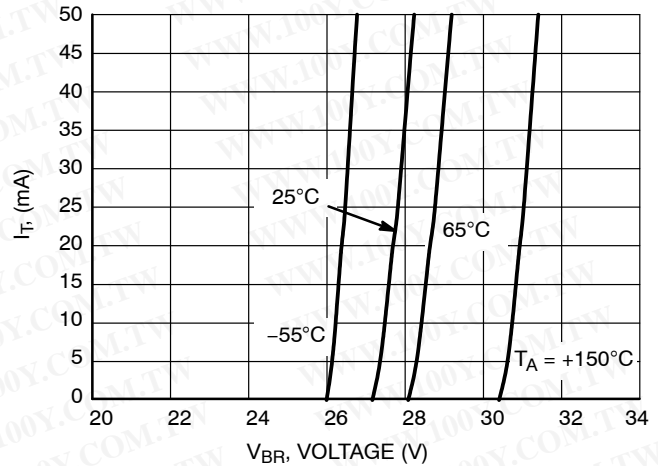

Figure 4. V_{BR} versus I_T Characteristics

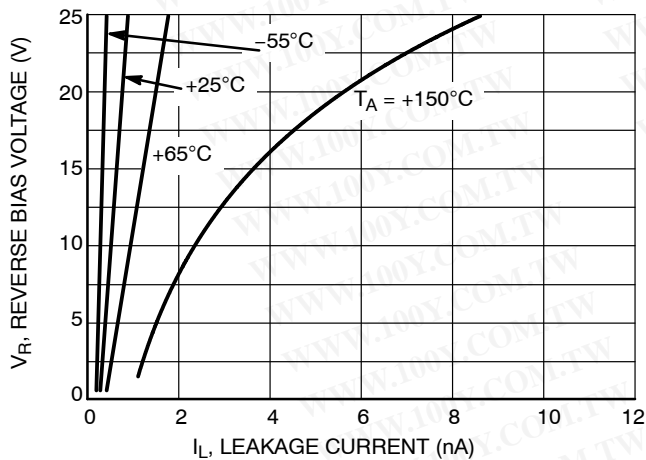

Figure 5. I_R versus Temperature Characteristics

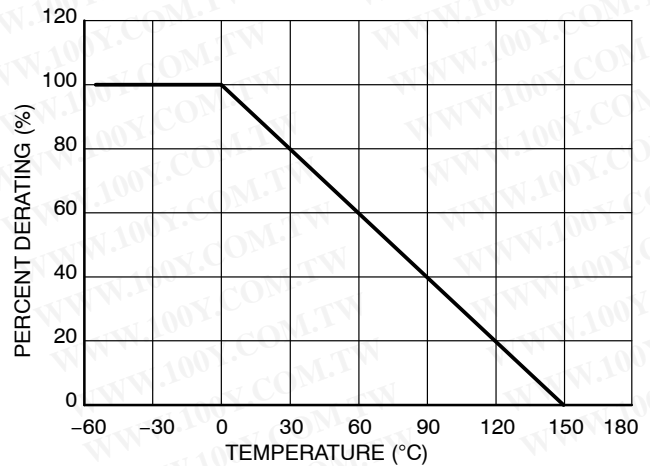

Figure 6. Temperature Power Dissipation Derating

NUP2105L, SZNUP2105L

APPLICATIONS

Background

The Controller Area Network (CAN) is a serial communication protocol designed for providing reliable high speed data transmission in harsh environments. TVS diodes provide a low cost solution to conducted and radiated Electromagnetic Interference (EMI) and Electrostatic Discharge (ESD) noise problems. The noise immunity level and reliability of CAN transceivers can be easily increased by adding external TVS diodes to prevent transient voltage failures.

The NUP2105L provides a transient voltage suppression solution for CAN data communication lines. The NUP2105L is a dual bidirectional TVS device in a compact SOT-23 package. This device is based on Zener technology that optimizes the active area of a PN junction to provide robust protection against transient EMI surge voltage and

ESD. The NUP2105L has been tested to EMI and ESD levels that exceed the specifications of popular high speed CAN networks.

CAN Physical Layer Requirements

Table 1 provides a summary of the system requirements for a CAN transceiver. The ISO 11898-2 physical layer specification forms the baseline for most CAN systems. The transceiver requirements for the Honeywell® Smart Distribution Systems (SDS®) and Rockwell (Allen-Bradley) DeviceNet™ high speed CAN networks are similar to ISO 11898-2. The SDS and DeviceNet transceiver requirements are similar to ISO 11898-2; however, they include minor modifications required in an industrial environment.

Table 1. Transceiver Requirements for High-Speed CAN Networks

Parameter	ISO 11898-2	SDS Physical Layer Specification 2.0	DeviceNet
Min / Max Bus Voltage (12 V System)	-3.0 V / 16 V	11 V / 25 V	Same as ISO 11898-2
Common Mode Bus Voltage	CAN_L: -2.0 V (min) 2.5 V (nom) CAN_H: 2.5 V (nom) 7.0 V (max)	Same as ISO 11898-2	Same as ISO 11898-2
Transmission Speed	1.0 Mb/s @ 40 m 125 kb/s @ 500 m	Same as ISO 11898-2	500 kb/s @ 100 m 125 kb/s @ 500 m
ESD	Not specified, recommended ≥ ±8.0 kV (contact)	Not specified, recommended ≥ ±8.0 kV (contact)	Not specified, recommended ≥ ±8.0 kV (contact)
EMI Immunity	ISO 7637-3, pulses 'a' and 'b'	IEC 61000-4-4 EFT	Same as ISO 11898-2
Popular Applications	Automotive, Truck, Medical and Marine Systems	Industrial Control Systems	Industrial Control Systems

NUP2105L, SZNUP2105L

EMI Specifications

The EMI protection level provided by the TVS device can be measured using the International Organization for Standardization (ISO) 7637-1 and -3 specifications that are representative of various noise sources. The ISO 7637-1 specification is used to define the susceptibility to coupled transient noise on a 12 V power supply, while ISO 7637-3 defines the noise immunity tests for data lines. The ISO 7637 tests also verify the robustness and reliability of a design by applying the surge voltage for extended durations.

The IEC 61000-4-X specifications can also be used to quantify the EMI immunity level of a CAN system. The IEC

61000-4 and ISO 7637 tests are similar; however, the IEC standard was created as a generic test for any electronic system, while the ISO 7637 standard was designed for vehicular applications. The IEC61000-4-4 Electrical Fast Transient (EFT) specification is similar to the ISO 7637-1 pulse 1 and 2 tests and is a requirement of SDS CAN systems. The IEC 61000-4-5 test is used to define the power absorption capacity of a TVS device and long duration voltage transients such as lightning. Table 2 provides a summary of the ISO 7637 and IEC 61000-4-X test specifications. Table 3 provides the NUP2105L's ESD test results.

Table 2. ISO 7637 and IEC 61000-4-X Test Specifications

Test	Waveform	Test Specifications	NUP2105L Test	Simulated Noise Source
ISO 7637-1 12 V Power Supply Lines	Pulse 1	$V_s = 0$ to -100 V $I_{max} = 10$ A $t_{duration} = 5000$ pulses	$I_{max} = 1.75$ A $V_{clamp_max} = 31$ V $t_{duration} = 5000$ pulses $R_i = 10 \Omega$, $t_r = 1.0 \mu s$, $t_{d_10\%} = 2000 \mu s$, $t_1 = 2.5$ s, $t_2 = 200$ ms, $t_3 = 100 \mu s$	DUT in parallel with inductive load that is disconnected from power supply.
	Pulse 2	$V_s = 0$ to $+100$ V $I_{max} = 10$ A $t_{duration} = 5000$ pulses	$I_{max} = 9.5$ A $V_{clamp_max} = 33$ V $t_{duration} = 5000$ pulses $R_i = 10 \Omega$, $t_r = 1.0 \mu s$, $t_{d_10\%} = 50 \mu s$, $t_1 = 2.5$ s, $t_2 = 200$ ms	DUT in series with inductor that is disconnected.
ISO 7637-3 Data Line EFT	Pulse 'a'	$V_s = -60$ V $I_{max} = 1.2$ A $t_{duration} = 10$ minutes	$I_{max} = 50$ A $V_{clamp_max} = 40$ V $t_{duration} = 60$ minutes $R_i = 50 \Omega$, $t_r = 5.0$ ns, $t_{d_10\%} = 0.1$ ms, $t_1 = 100 \mu s$, $t_2 = 10$ ms, $t_3 = 90$ ms	Switching noise of inductive loads.
	Pulse 'b'	$V_s = +40$ V $I_{max} = 0.8$ A $t_{duration} = 10$ minutes		
IEC 61000-4-4 Data Line EFT		$V_{open\ circuit} = 2.0$ kV $I_{short\ circuit} = 40$ A (Level 4 = Severe Industrial Environment) $R_i = 50 \Omega$, $t_r < 5.0$ ns, $t_{d_50\%} = 50$ ns, $t_{burst} = 15$ ms, $f_{burst} = 2.0$ to 5.0 kHz, $t_{repeat} = 300$ ms $t_{duration} = 1$ minute	(Note 2)	Switching noise of inductive loads.
IEC 61000-4-5		$V_{open\ circuit} = 1.2 \times 50 \mu s$, $I_{short\ circuit} = 8 \times 20 \mu s$ $R_i = 50 \Omega$		Lightning, nonrepetitive power line and load switching

1. DUT = device under test.

2. The EFT immunity level was measured with test limits beyond the IEC 61000-4-4 test, but with the more severe test conditions of ISO 7637-3.

Table 3. NUP2105L ESD Test Results

ESD Specification	Test	Test Level	Pass / Fail
Human Body Model	Contact	16 kV	Pass
IEC 61000-4-2	Contact	30 kV (Note 3)	Pass
	Non-contact (Air Discharge)	30 kV (Note 3)	Pass

3. Test equipment maximum test voltage is 30 kV.

NUP2105L, SZNUP2105L

TVS Diode Protection Circuit

TVS diodes provide protection to a transceiver by clamping a surge voltage to a safe level. TVS diodes have high impedance below and low impedance above their breakdown voltage. A TVS Zener diode has its junction optimized to absorb the high peak energy of a transient event, while a standard Zener diode is designed and specified to clamp a steady state voltage.

Figure 7 provides an example of a dual bidirectional TVS diode array that can be used for protection with the high-speed CAN network. The bidirectional array is created from four identical Zener TVS diodes. The clamping voltage of the composite device is equal to the breakdown

voltage of the diode that is reversed biased, plus the diode drop of the second diode that is forward biased.

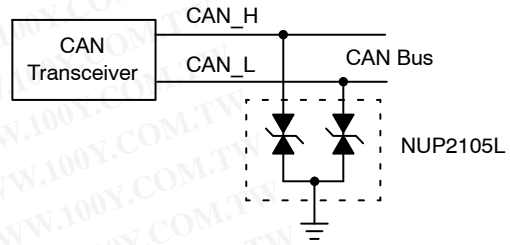
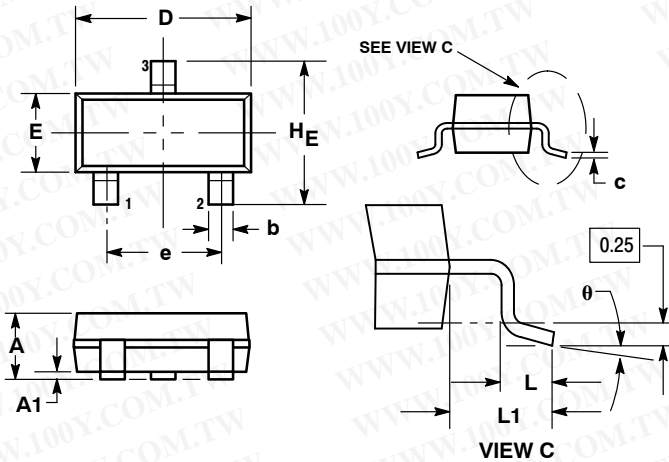

Figure 7. High-Speed and Fault Tolerant CAN TVS Protection Circuit

NUP2105L, SZNUP2105L

PACKAGE DIMENSIONS

SOT-23 (TO-236)
CASE 318-08
ISSUE AP



NOTES:

1. DIMENSIONING AND TOLERANCING PER ANSI Y14.5M, 1982.
2. CONTROLLING DIMENSION: INCH.
3. MAXIMUM LEAD THICKNESS INCLUDES LEAD FINISH THICKNESS. MINIMUM LEAD THICKNESS IS THE MINIMUM THICKNESS OF BASE MATERIAL.
4. DIMENSIONS D AND E DO NOT INCLUDE MOLD FLASH, PROTRUSIONS, OR GATE BURRS.

DIM	MILLIMETERS			INCHES		
	MIN	NOM	MAX	MIN	NOM	MAX
A	0.89	1.00	1.11	0.035	0.040	0.044
A1	0.01	0.06	0.10	0.001	0.002	0.004
b	0.37	0.44	0.50	0.015	0.018	0.020
c	0.09	0.13	0.18	0.003	0.005	0.007
D	2.80	2.90	3.04	0.110	0.114	0.120
E	1.20	1.30	1.40	0.047	0.051	0.055
e	1.78	1.90	2.04	0.070	0.075	0.081
L	0.10	0.20	0.30	0.004	0.008	0.012
L1	0.35	0.54	0.69	0.014	0.021	0.029
HE	2.10	2.40	2.64	0.083	0.094	0.104
θ	0°	---	10°	0°	---	10°

STYLE 27:
PIN 1. CATHODE
2. CATHODE
3. CATHODE

SOLDERING FOOTPRINT

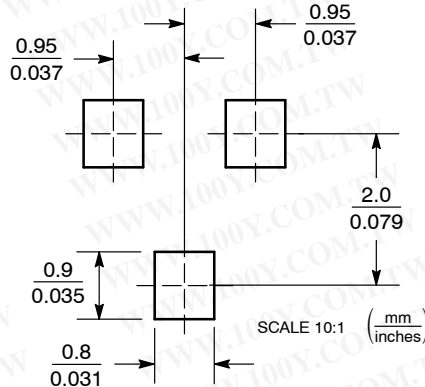

勝特力材料 886-3-5753170
勝特力电子(上海) 86-21-34970699
勝特力电子(深圳) 86-755-83298787
[Http://www.100y.com.tw](http://www.100y.com.tw)

Honeywell and SDS are registered trademarks of Honeywell International Inc.
DeviceNet is a trademark of Rockwell Automation.

ON Semiconductor and are registered trademarks of Semiconductor Components Industries, LLC (SCILLC). SCILLC reserves the right to make changes without further notice to any products herein. SCILLC makes no warranty, representation or guarantee regarding the suitability of its products for any particular purpose, nor does SCILLC assume any liability arising out of the application or use of any product or circuit, and specifically disclaims any and all liability, including without limitation special, consequential or incidental damages. "Typical" parameters which may be provided in SCILLC data sheets and/or specifications can and do vary in different applications and actual performance may vary over time. All operating parameters, including "Typicals" must be validated for each customer application by customer's technical experts. SCILLC does not convey any license under its patent rights nor the rights of others. SCILLC products are not designed, intended, or authorized for use as components in systems intended for surgical implant into the body, or other applications intended to support or sustain life, or for any other application in which the failure of the SCILLC product could create a situation where personal injury or death may occur. Should Buyer purchase or use SCILLC products for any such unintended or unauthorized application, Buyer shall indemnify and hold SCILLC and its officers, employees, subsidiaries, affiliates, and distributors harmless against all claims, costs, damages, and expenses, and reasonable attorney fees arising out of, directly or indirectly, any claim of personal injury or death associated with such unintended or unauthorized use, even if such claim alleges that SCILLC was negligent regarding the design or manufacture of the part. SCILLC is an Equal Opportunity/Affirmative Action Employer. This literature is subject to all applicable copyright laws and is not for resale in any manner.

PUBLICATION ORDERING INFORMATION

LITERATURE FULFILLMENT:
Literature Distribution Center for ON Semiconductor
P.O. Box 5163, Denver, Colorado 80217 USA
Phone: 303-675-2175 or 800-344-3860 Toll Free USA/Canada
Fax: 303-675-2176 or 800-344-3867 Toll Free USA/Canada
Email: orderlit@onsemi.com

N. American Technical Support: 800-282-9855 Toll Free
USA/Canada
Europe, Middle East and Africa Technical Support:
Phone: 421 33 790 2910
Japan Customer Focus Center
Phone: 81-3-5817-1050

ON Semiconductor Website: www.onsemi.com

Order Literature: <http://www.onsemi.com/orderlit>

For additional information, please contact your local Sales Representative