

# D44H Series (NPN), D45H Series (PNP)

Preferred Devices

## Complementary Silicon Power Transistors

These series of plastic, silicon NPN and PNP power transistors can be used as general purpose power amplification and switching such as output or driver stages in applications such as switching regulators, converters and power amplifiers.

### Features

- Pb-Free Package is Available
- Low Collector-Emitter Saturation Voltage  
 $V_{CE(sat)} = 1.0 \text{ V (Max) @ } 8.0 \text{ A}$
- Fast Switching Speeds
- Complementary Pairs Simplifies Designs

### MAXIMUM RATINGS

Rating	Symbol	Value	Unit
Collector-Emitter Voltage D44H8, D45H8 D44H11, D45H11	$V_{CEO}$	60 80	Vdc
Emitter Base Voltage	$V_{EB}$	5.0	Vdc
Collector Current – Continuous – Peak (Note 1)	$I_C$	10 20	Adc
Total Power Dissipation @ $T_C = 25^\circ\text{C}$ @ $T_A = 25^\circ\text{C}$	$P_D$	50 2.0	W
Operating and Storage Junction Temperature Range	$T_J, T_{stg}$	-55 to +150	$^\circ\text{C}$

Maximum ratings are those values beyond which device damage can occur. Maximum ratings applied to the device are individual stress limit values (not normal operating conditions) and are not valid simultaneously. If these limits are exceeded, device functional operation is not implied, damage may occur and reliability may be affected.

### THERMAL CHARACTERISTICS

Characteristic	Symbol	Max	Unit
Thermal Resistance, Junction-to-Case	$R_{\theta JC}$	2.5	$^\circ\text{C/W}$
Thermal Resistance, Junction-to-Ambient	$R_{\theta JA}$	62.5	$^\circ\text{C/W}$
Maximum Lead Temperature for Soldering Purposes: 1/8" from Case for 5 Seconds	$T_L$	275	$^\circ\text{C}$

1. Pulse Width  $\leq 6.0 \text{ ms}$ , Duty Cycle  $\leq 50\%$ .

\*For additional information on our Pb-Free strategy and soldering details, please download the ON Semiconductor Soldering and Mounting Techniques Reference Manual, SOLDERRM/D.



ON Semiconductor®

http://onsemi.com

## 10 A COMPLEMENTARY SILICON POWER TRANSISTORS 60, 80 V

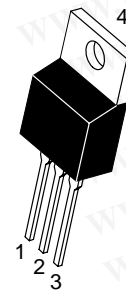

TO-220AB  
CASE 221A  
STYLE 1

### MARKING DIAGRAM



x = 4 or 5  
 yy = 8 or 11  
 A = Assembly Location  
 Y = Year  
 WW = Work Week

### ORDERING INFORMATION

Device	Package	Shipping†
D44H8	TO-220	50 Units/Rail
D44H11	TO-220	50 Units/Rail
D45H8	TO-220	50 Units/Rail
D45H8G	TO-220 (Pb-Free)	50 Units/Rail
D45H11	TO-220	50 Units/Rail

†For information on tape and reel specifications, including part orientation and tape sizes, please refer to our Tape and Reel Packaging Specifications Brochure, BRD8011/D.

Preferred devices are recommended choices for future use and best overall value.

## D44H Series (NPN), D45H Series (PNP)

### ELECTRICAL CHARACTERISTICS (T<sub>C</sub> = 25°C unless otherwise noted)

Characteristic	Symbol	Min	Max	Unit
DC Current Gain (V <sub>CE</sub> = 1.0 Vdc, I <sub>C</sub> = 2.0 Adc)	h <sub>FE</sub>			–
		D44H8, 11	20	–
	D45H8, 11	40	–	
	(V <sub>CE</sub> = 1.0 Vdc, I <sub>C</sub> = 4.0 Adc)	D44H8, 11	20	–
D45H8, 11		40	–	

### ELECTRICAL CHARACTERISTICS (T<sub>C</sub> = 25°C unless otherwise noted)

Characteristic	Symbol	Min	Typ	Max	Unit
----------------	--------	-----	-----	-----	------

### OFF CHARACTERISTICS

Collector Cutoff Current (V <sub>CE</sub> = Rated V <sub>CEO</sub> , V <sub>BE</sub> = 0)	I <sub>CES</sub>	–	–	10	μA
Emitter Cutoff Current (V <sub>EB</sub> = 5.0 Vdc)	I <sub>EBO</sub>	–	–	100	μA

### ON CHARACTERISTICS

Collector–Emitter Saturation Voltage (I <sub>C</sub> = 8.0 Adc, I <sub>B</sub> = 0.4 Adc) (I <sub>C</sub> = 8.0 Adc, I <sub>B</sub> = 0.8 Adc)	V <sub>CE(sat)</sub>	–	–	1.0	Vdc
		–	–	1.0	
Base–Emitter Saturation Voltage (I <sub>C</sub> = 8.0 Adc, I <sub>B</sub> = 0.8 Adc)	V <sub>BE(sat)</sub>	–	–	1.5	Vdc

### DYNAMIC CHARACTERISTICS

Collector Capacitance (V <sub>CB</sub> = 10 Vdc, f <sub>test</sub> = 1.0 MHz)	C <sub>cb</sub>	–	130	–	pF
		–	230	–	
Gain Bandwidth Product (I <sub>C</sub> = 0.5 Adc, V <sub>CE</sub> = 10 Vdc, f = 20 MHz)	f <sub>T</sub>	–	50	–	MHz
		–	40	–	

### SWITCHING TIMES

Delay and Rise Times (I <sub>C</sub> = 5.0 Adc, I <sub>B1</sub> = 0.5 Adc)	t <sub>d</sub> + t <sub>r</sub>	–	300	–	ns
		–	135	–	
Storage Time (I <sub>C</sub> = 5.0 Adc, I <sub>B1</sub> = I <sub>B2</sub> = 0.5 Adc)	t <sub>s</sub>	–	500	–	ns
		–	500	–	
Fall Time (I <sub>C</sub> = 5.0 Adc, I <sub>B1</sub> = 102 = 0.5 Adc)	t <sub>f</sub>	–	140	–	ns
		–	100	–	

勝特力材料 886-3-5753170  
 勝特力电子(上海) 86-21-34970699  
 勝特力电子(深圳) 86-755-83298787  
[Http://www.100y.com.tw](http://www.100y.com.tw)

# D44H Series (NPN), D45H Series (PNP)

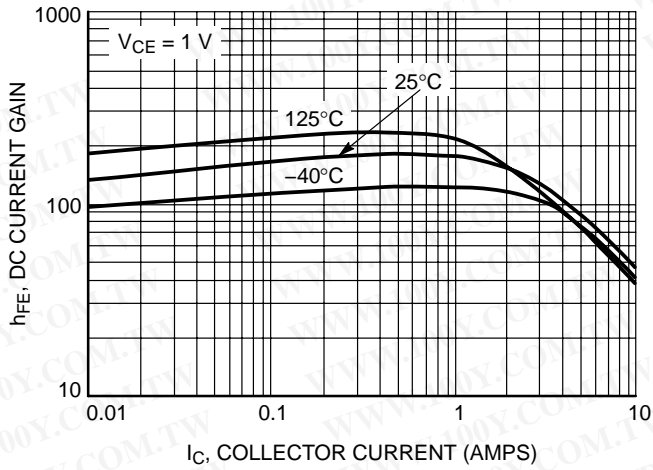

Figure 1. D44H11 DC Current Gain

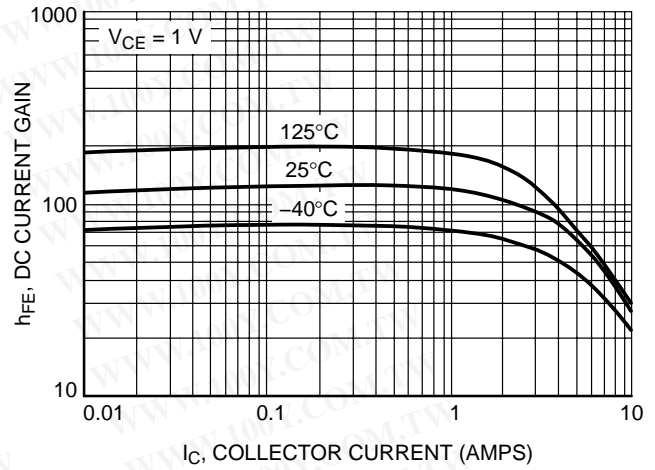

Figure 2. D45H11 DC Current Gain

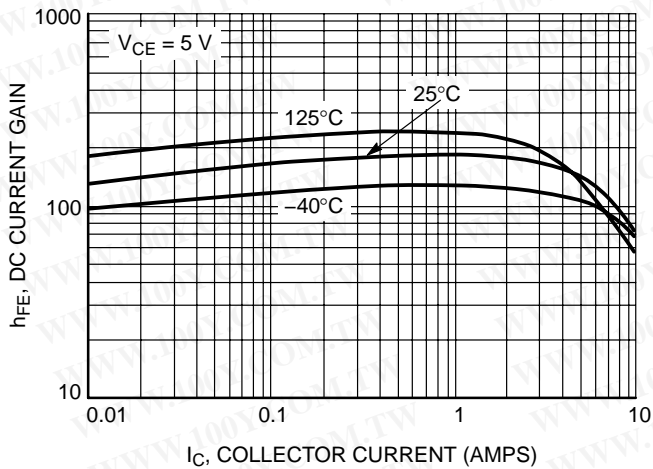

Figure 3. D44H11 DC Current Gain

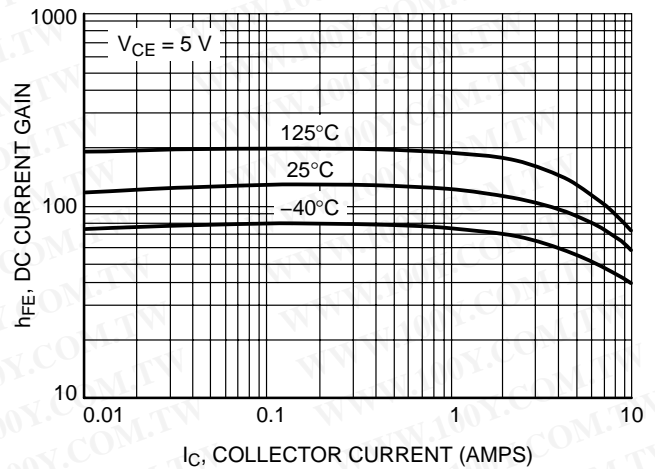

Figure 4. D45H11 DC Current Gain

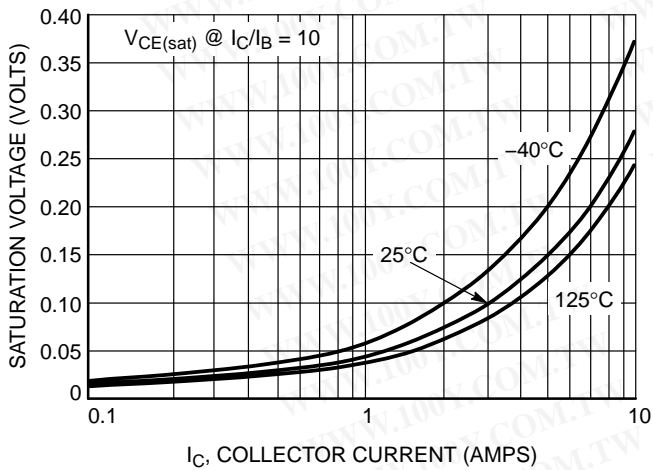

Figure 5. D44H11 ON-Voltage

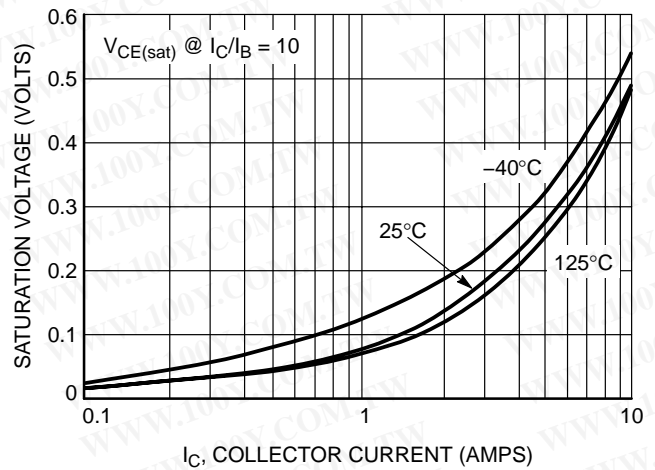

Figure 6. D45H11 ON-Voltage

# D44H Series (NPN), D45H Series (PNP)

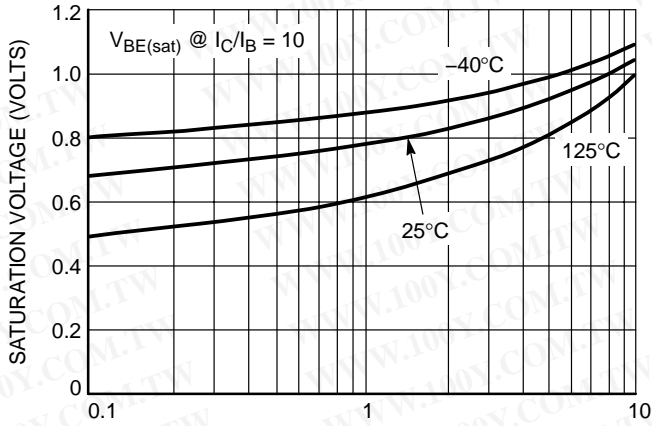

Figure 7. D44H11 ON-Voltage

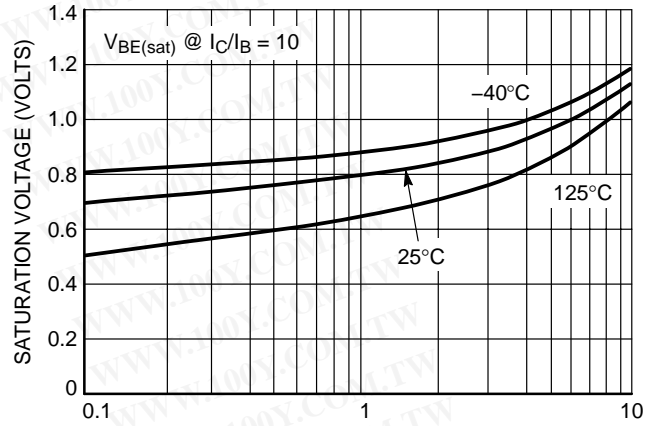

Figure 8. D45H11 ON-Voltage

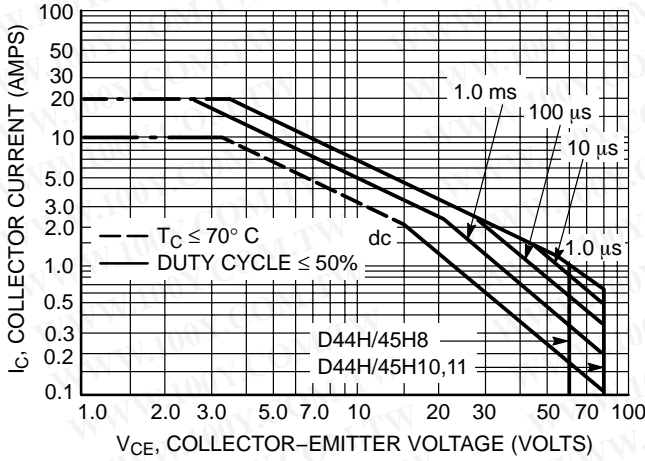

Figure 9. Maximum Rated Forward Bias Safe Operating Area

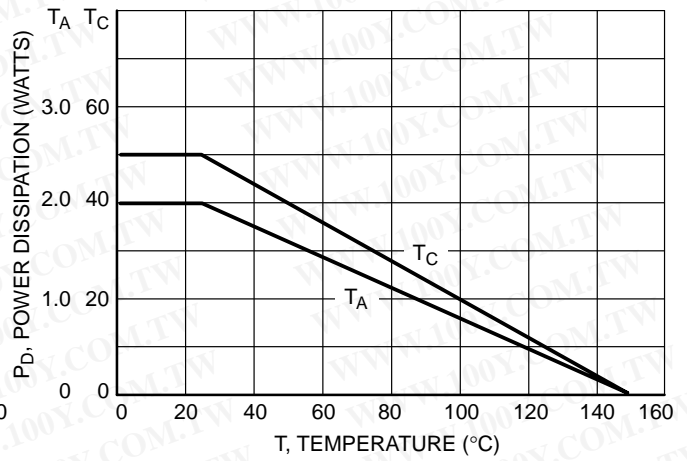

Figure 10. Power Derating

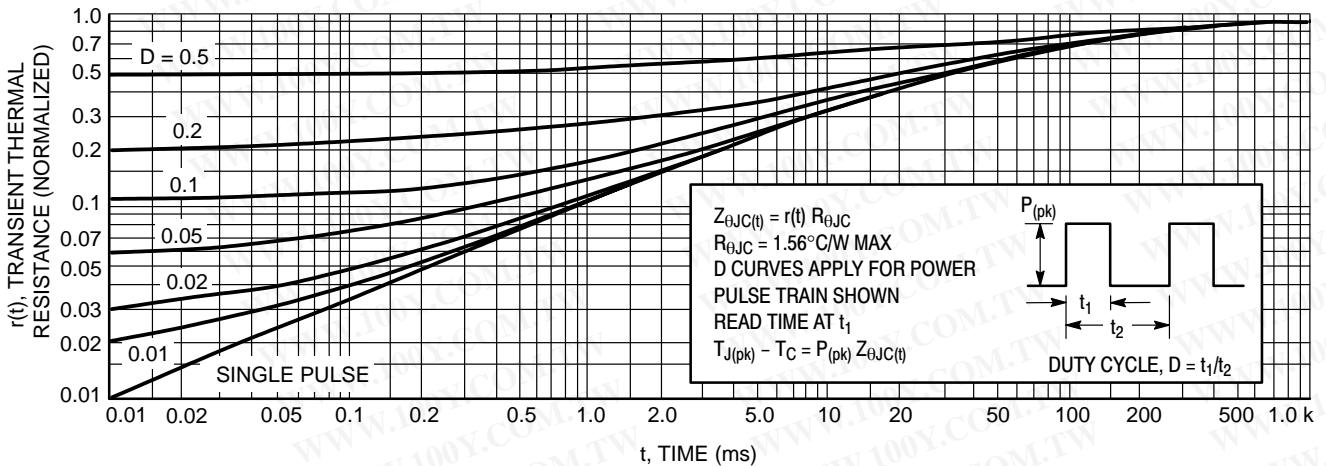

Figure 11. Thermal Response



# D44H Series (NPN), D45H Series (PNP)

## PACKAGE DIMENSIONS

TO-220  
PLASTIC  
CASE 221A-09  
ISSUE AA

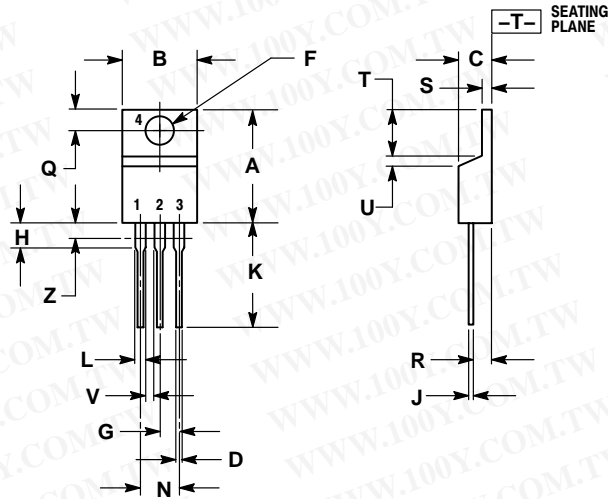

- NOTES:
1. DIMENSIONING AND TOLERANCING PER ANSI Y14.5M, 1982.
  2. CONTROLLING DIMENSION: INCH.
  3. DIMENSION Z DEFINES A ZONE WHERE ALL BODY AND LEAD IRREGULARITIES ARE ALLOWED.

DIM	INCHES		MILLIMETERS	
	MIN	MAX	MIN	MAX
A	0.570	0.620	14.48	15.75
B	0.380	0.405	9.66	10.28
C	0.160	0.190	4.07	4.82
D	0.025	0.035	0.64	0.88
F	0.142	0.147	3.61	3.73
G	0.095	0.105	2.42	2.66
H	0.110	0.155	2.80	3.93
J	0.018	0.025	0.46	0.64
K	0.500	0.562	12.70	14.27
L	0.045	0.060	1.15	1.52
N	0.190	0.210	4.83	5.33
Q	0.100	0.120	2.54	3.04
R	0.080	0.110	2.04	2.79
S	0.045	0.055	1.15	1.39
T	0.235	0.255	5.97	6.47
U	0.000	0.050	0.00	1.27
V	0.045	---	1.15	---
Z	---	0.080	---	2.04

- STYLE 1:  
PIN 1. BASE  
2. COLLECTOR  
3. EMITTER  
4. COLLECTOR

勝特力材料 886-3-5753170  
 勝特力电子(上海) 86-21-34970699  
 勝特力电子(深圳) 86-755-83298787  
[Http://www.100y.com.tw](http://www.100y.com.tw)

## D44H Series (NPN), D45H Series (PNP)

勝特力材料 886-3-5753170  
勝特力电子(上海) 86-21-34970699  
勝特力电子(深圳) 86-755-83298787  
[Http://www.100y.com.tw](http://www.100y.com.tw)

**ON Semiconductor** and  are registered trademarks of Semiconductor Components Industries, LLC (SCILLC). SCILLC reserves the right to make changes without further notice to any products herein. SCILLC makes no warranty, representation or guarantee regarding the suitability of its products for any particular purpose, nor does SCILLC assume any liability arising out of the application or use of any product or circuit, and specifically disclaims any and all liability, including without limitation special, consequential or incidental damages. "Typical" parameters which may be provided in SCILLC data sheets and/or specifications can and do vary in different applications and actual performance may vary over time. All operating parameters, including "Typicals" must be validated for each customer application by customer's technical experts. SCILLC does not convey any license under its patent rights nor the rights of others. SCILLC products are not designed, intended, or authorized for use as components in systems intended for surgical implant into the body, or other applications intended to support or sustain life, or for any other application in which the failure of the SCILLC product could create a situation where personal injury or death may occur. Should Buyer purchase or use SCILLC products for any such unintended or unauthorized application, Buyer shall indemnify and hold SCILLC and its officers, employees, subsidiaries, affiliates, and distributors harmless against all claims, costs, damages, and expenses, and reasonable attorney fees arising out of, directly or indirectly, any claim of personal injury or death associated with such unintended or unauthorized use, even if such claim alleges that SCILLC was negligent regarding the design or manufacture of the part. SCILLC is an Equal Opportunity/Affirmative Action Employer. This literature is subject to all applicable copyright laws and is not for resale in any manner.

### PUBLICATION ORDERING INFORMATION

#### LITERATURE FULFILLMENT:

Literature Distribution Center for ON Semiconductor  
P.O. Box 61312, Phoenix, Arizona 85082-1312 USA  
**Phone:** 480-829-7710 or 800-344-3860 Toll Free USA/Canada  
**Fax:** 480-829-7709 or 800-344-3867 Toll Free USA/Canada  
**Email:** [orderlit@onsemi.com](mailto:orderlit@onsemi.com)

**N. American Technical Support:** 800-282-9855 Toll Free  
USA/Canada

**Japan:** ON Semiconductor, Japan Customer Focus Center  
2-9-1 Kamimeguro, Meguro-ku, Tokyo, Japan 153-0051  
**Phone:** 81-3-5773-3850

**ON Semiconductor Website:** <http://onsemi.com>

**Order Literature:** <http://www.onsemi.com/litorder>

For additional information, please contact your  
local Sales Representative.