

MJE15032 (NPN), MJE15033 (PNP)

Preferred Devices

Complementary Silicon Plastic Power Transistors

Designed for use as high-frequency drivers in audio amplifiers.

Features

- DC Current Gain Specified to 5.0 Amperes
 $h_{FE} = 70$ (Min) @ $I_C = 0.5$ Adc
 $= 10$ (Min) @ $I_C = 2.0$ Adc
- Collector–Emitter Sustaining Voltage –
 $V_{CEO(sus)} = 250$ Vdc (Min) – MJE15032, MJE15033
- High Current Gain – Bandwidth Product
 $f_T = 30$ MHz (Min) @ $I_C = 500$ mAdc
- TO–220AB Compact Package
- Epoxy Meets UL 94 V–0 @ 0.125 in
- ESD Ratings: Machine Model C
 Human Body Model 3B
- Pb–Free Packages are Available*

MAXIMUM RATINGS

Rating	Symbol	Value	Unit
Collector–Emitter Voltage	V_{CEO}	250	Vdc
Collector–Base Voltage	V_{CB}	250	Vdc
Emitter–Base Voltage	V_{EB}	5.0	Vdc
Collector Current – Continuous – Peak	I_C	8.0 16	Adc
Base Current	I_B	2.0	Adc
Total Power Dissipation @ $T_C = 25^\circ\text{C}$ Derate above 25°C	P_D	50 0.40	W W/ $^\circ\text{C}$
Total Power Dissipation @ $T_A = 25^\circ\text{C}$ Derate above 25°C	P_D	2.0 0.016	W W/ $^\circ\text{C}$
Operating and Storage Junction Temperature Range	T_J, T_{stg}	–65 to +150	$^\circ\text{C}$

THERMAL CHARACTERISTICS

Characteristic	Symbol	Max	Unit
Thermal Resistance, Junction–to–Case	$R_{\theta JC}$	2.5	$^\circ\text{C}/\text{W}$
Thermal Resistance, Junction–to–Ambient	$R_{\theta JA}$	62.5	$^\circ\text{C}/\text{W}$

Maximum ratings are those values beyond which device damage can occur. Maximum ratings applied to the device are individual stress limit values (not normal operating conditions) and are not valid simultaneously. If these limits are exceeded, device functional operation is not implied, damage may occur and reliability may be affected.

*For additional information on our Pb–Free strategy and soldering details, please download the ON Semiconductor Soldering and Mounting Techniques Reference Manual, SOLDERRM/D.



ON Semiconductor®

<http://onsemi.com>

8.0 AMPERES POWER TRANSISTORS COMPLEMENTARY SILICON 250 VOLTS, 50 WATTS

MARKING DIAGRAM

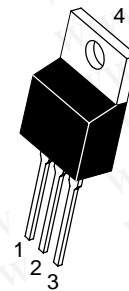

TO–220
CASE 221A
STYLE 1

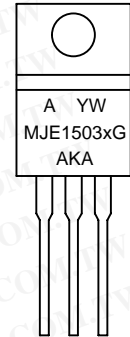

MJE1503x = Specific Device Code
 x = 2 or 3
 A = Assembly Location
 Y = Year
 W = Work Week
 G = Pb–Package

ORDERING INFORMATION

Device	Package	Shipping†
MJE15032	TO–220	50 Units/Rail
MJE15032G	TO–220 (Pb–Free)	50 Units/Rail
MJE15033	TO–220	50 Units/Rail
MJE15033G	TO–220 (Pb–Free)	50 Units/Rail

†For information on tape and reel specifications, including part orientation and tape sizes, please refer to our Tape and Reel Packaging Specifications Brochure, BRD8011/D.

Preferred devices are recommended choices for future use and best overall value.

MJE15032 (NPN), MJE15033 (PNP)

ELECTRICAL CHARACTERISTICS ($T_C = 25^\circ\text{C}$ unless otherwise noted)

Characteristic	Symbol	Min	Max	Unit
OFF CHARACTERISTICS				
Collector–Emitter Sustaining Voltage (Note 1) ($I_C = 10\text{ mAdc}$, $I_B = 0$)	$V_{CEO(sus)}$	250	–	Vdc
Collector Cutoff Current ($V_{CB} = 250\text{ Vdc}$, $I_E = 0$)	I_{CBO}	–	10	μAdc
Emitter Cutoff Current ($V_{BE} = 5.0\text{ Vdc}$, $I_C = 0$)	I_{EBO}	–	10	μAdc
ON CHARACTERISTICS (Note 1)				
DC Current Gain ($I_C = 0.5\text{ Adc}$, $V_{CE} = 5.0\text{ Vdc}$) ($I_C = 1.0\text{ Adc}$, $V_{CE} = 5.0\text{ Vdc}$) ($I_C = 2.0\text{ Adc}$, $V_{CE} = 5.0\text{ Vdc}$)	h_{FE}	70 50 10	– – –	–
Collector–Emitter Saturation Voltage ($I_C = 1.0\text{ Adc}$, $I_B = 0.1\text{ Adc}$)	$V_{CE(sat)}$	–	0.5	Vdc
Base–Emitter On Voltage ($I_C = 1.0\text{ Adc}$, $V_{CE} = 5.0\text{ Vdc}$)	$V_{BE(on)}$	–	1.0	Vdc
DYNAMIC CHARACTERISTICS				
Current Gain – Bandwidth Product (Note 2) ($I_C = 500\text{ mAdc}$, $V_{CE} = 10\text{ Vdc}$, $f_{test} = 1.0\text{ MHz}$)	f_T	30	–	MHz

1. Pulse Test: Pulse Width $\leq 300\ \mu\text{s}$, Duty Cycle $\leq 2.0\%$.
2. $f_T = |h_{fe}| \cdot f_{test}$.

勝特力材料 886-3-5753170
 勝特力电子(上海) 86-21-34970699
 勝特力电子(深圳) 86-755-83298787
[Http://www.100y.com.tw](http://www.100y.com.tw)

MJE15032 (NPN), MJE15033 (PNP)

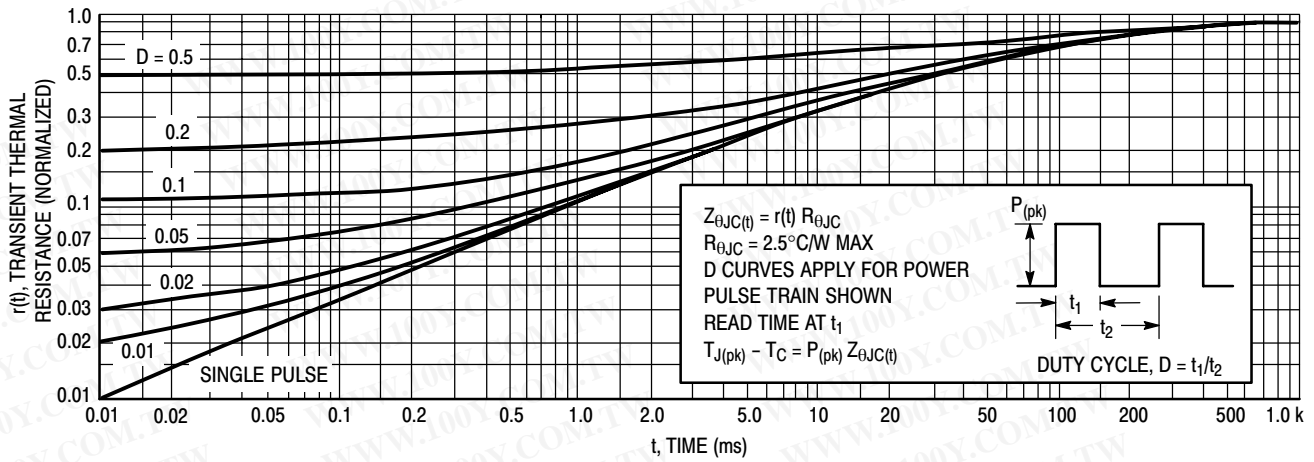

Figure 1. Thermal Response

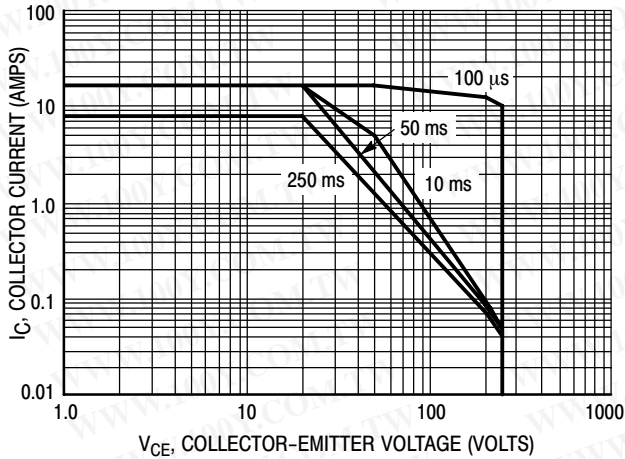

Figure 2. MJE15032 & MJE15033 Safe Operating Area

There are two limitations on the power handling ability of a transistor: average junction temperature and second breakdown. Safe operating area curves indicate $I_C - V_{CE}$ limits of the transistor that must be observed for reliable operation, i.e., the transistor must not be subjected to greater dissipation than the curves indicate.

The data of Figures 2 and 4 is based on $T_{J(pk)} = 150^\circ\text{C}$; T_C is variable depending on conditions. Second breakdown pulse limits are valid for duty cycles to 10% provided $T_{J(pk)} < 150^\circ\text{C}$. $T_{J(pk)}$ may be calculated from the data in Figure 1. At high case temperatures, thermal limitations will reduce the power that can be handled to values less than the limitations imposed by second breakdown.

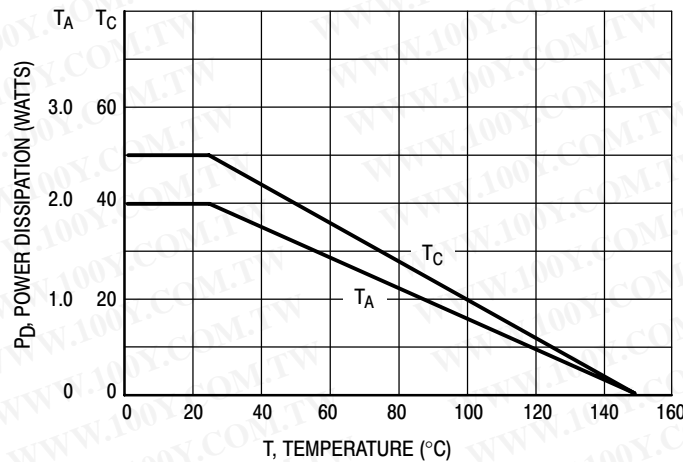

Figure 3. Power Derating

勝特力材料 886-3-5753170
 勝特力电子(上海) 86-21-34970699
 勝特力电子(深圳) 86-755-83298787
[Http://www.100y.com.tw](http://www.100y.com.tw)

MJE15032 (NPN), MJE15033 (PNP)

NPN – MJE15032

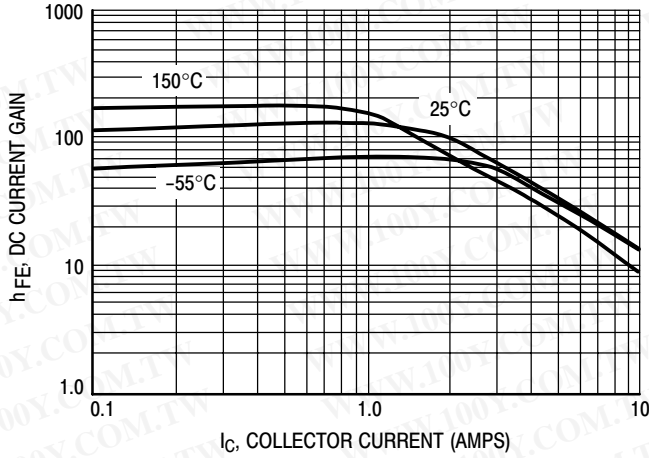

Figure 4. NPN – MJE15032
 $V_{CE} = 5\text{ V}$ DC Current Gain

PNP – MJE15033

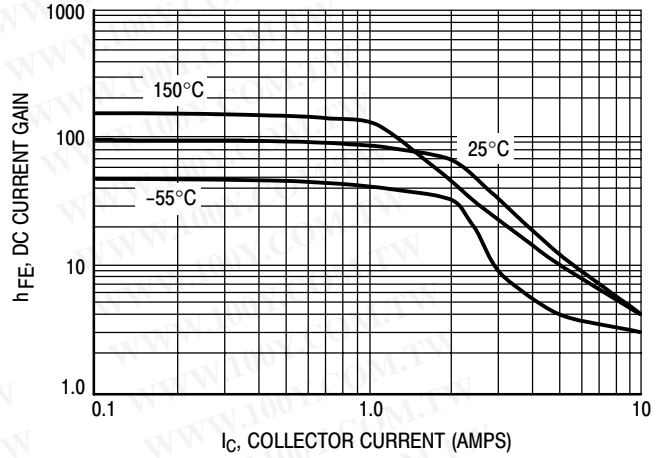

Figure 5. PNP – MJE15033
 $V_{CE} = 5\text{ V}$ DC Current Gain

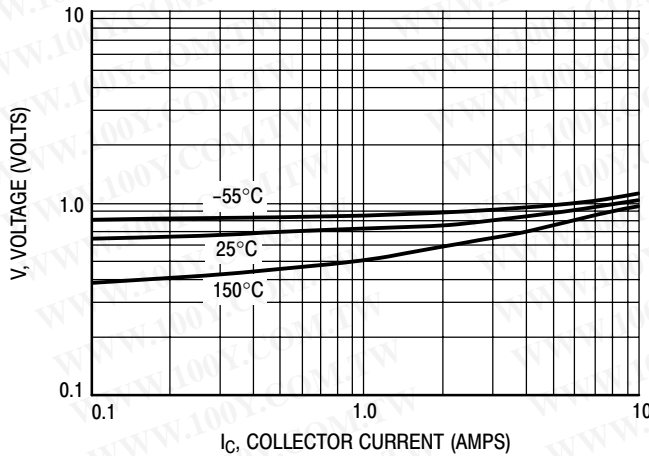

Figure 6. NPN – MJE15032
 $V_{CE} = 5\text{ V}$ $V_{BE(on)}$ Curve

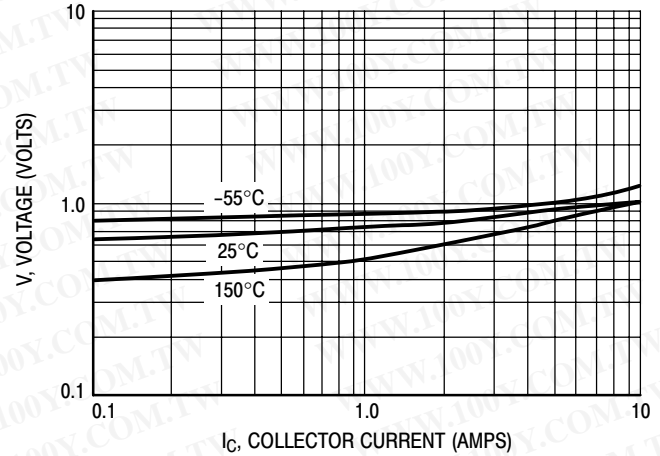

Figure 7. PNP – MJE15033
 $V_{CE} = 5\text{ V}$ $V_{BE(on)}$ Curve

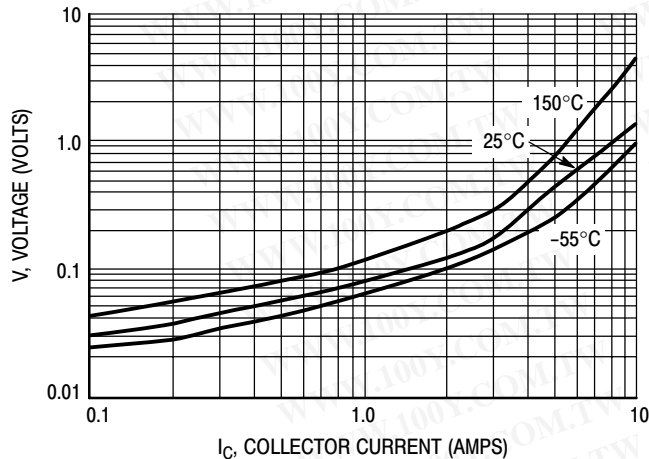

Figure 8. NPN – MJE15032
 $V_{CE(sat)}$ $I_C/I_B = 10$

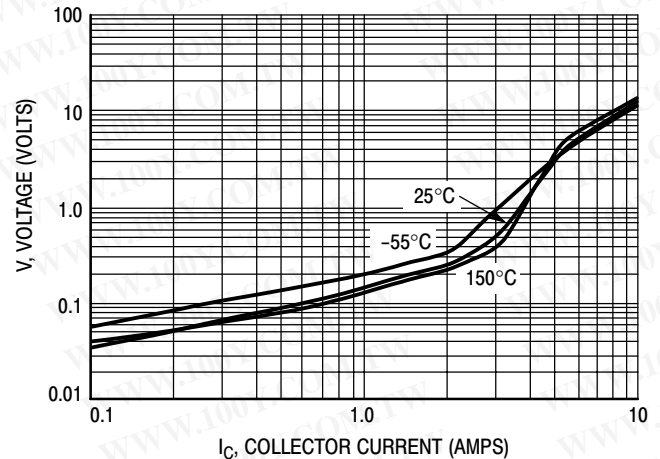

Figure 9. PNP – MJE15033
 $V_{CE(sat)}$ $I_C/I_B = 10$

勝特力材料 886-3-5753170
 勝特力电子(上海) 86-21-34970699
 勝特力电子(深圳) 86-755-83298787
[Http://www.100y.com.tw](http://www.100y.com.tw)

MJE15032 (NPN), MJE15033 (PNP)

NPN – MJE15032

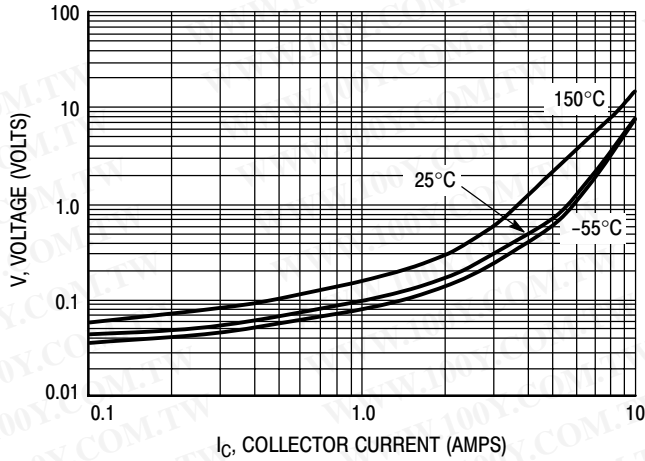

Figure 10. NPN – MJE15032
 $V_{CE(sat)} I_C/I_B = 20$

PNP – MJE15033

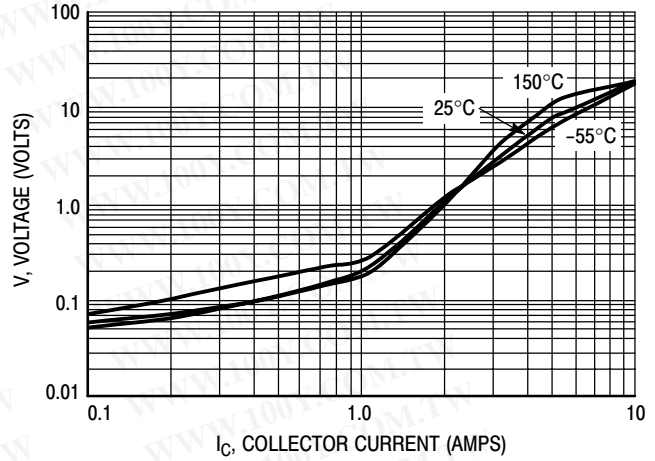

Figure 11. PNP – MJE15033
 $V_{CE(sat)} I_C/I_B = 20$

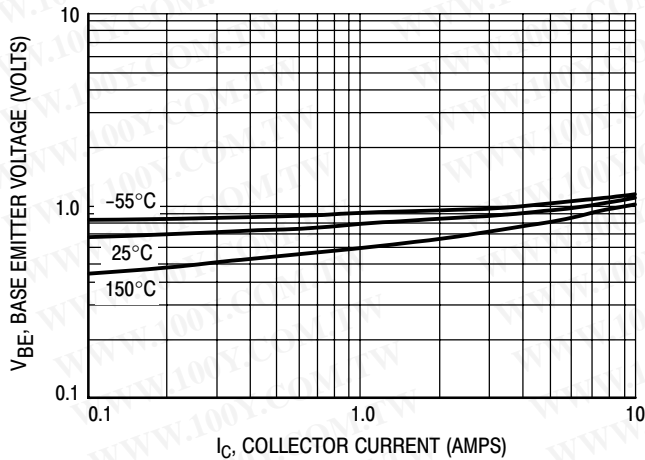

Figure 12. NPN – MJE15032
 $V_{BE(sat)} I_C/I_B = 10$

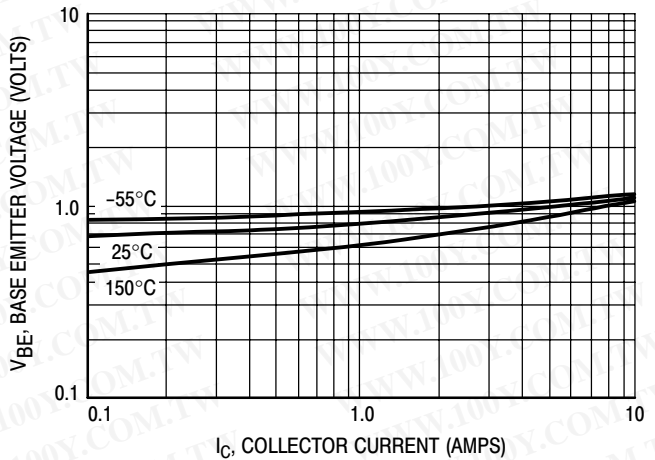

Figure 13. PNP – MJE15033
 $V_{BE(sat)} I_C/I_B = 10$

勝特力材料 886-3-5753170
 勝特力电子(上海) 86-21-34970699
 勝特力电子(深圳) 86-755-83298787
[Http://www.100y.com.tw](http://www.100y.com.tw)

MJE15032 (NPN), MJE15033 (PNP)

PACKAGE DIMENSIONS

TO-220
CASE 221A-09
ISSUE AA

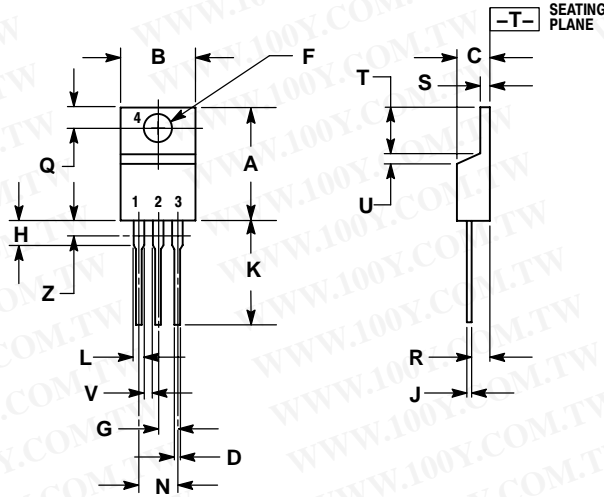

NOTES:

1. DIMENSIONING AND TOLERANCING PER ANSI Y14.5M, 1982.
2. CONTROLLING DIMENSION: INCH.
3. DIMENSION Z DEFINES A ZONE WHERE ALL BODY AND LEAD IRREGULARITIES ARE ALLOWED.

DIM	INCHES		MILLIMETERS	
	MIN	MAX	MIN	MAX
A	0.570	0.620	14.48	15.75
B	0.380	0.405	9.66	10.28
C	0.160	0.190	4.07	4.82
D	0.025	0.035	0.64	0.88
F	0.142	0.147	3.61	3.73
G	0.095	0.105	2.42	2.66
H	0.110	0.155	2.80	3.93
J	0.018	0.025	0.46	0.64
K	0.500	0.562	12.70	14.27
L	0.045	0.060	1.15	1.52
N	0.190	0.210	4.83	5.33
Q	0.100	0.120	2.54	3.04
R	0.080	0.110	2.04	2.79
S	0.045	0.055	1.15	1.39
T	0.235	0.255	5.97	6.47
U	0.000	0.050	0.00	1.27
V	0.045	---	1.15	---
Z	---	0.080	---	2.04

STYLE 1:

- PIN 1. BASE
2. COLLECTOR
3. EMITTER
4. COLLECTOR

勝特力材料 886-3-5753170
勝特力电子(上海) 86-21-34970699
勝特力电子(深圳) 86-755-83298787
[Http://www.100y.com.tw](http://www.100y.com.tw)

ON Semiconductor and  are registered trademarks of Semiconductor Components Industries, LLC (SCILLC). SCILLC reserves the right to make changes without further notice to any products herein. SCILLC makes no warranty, representation or guarantee regarding the suitability of its products for any particular purpose, nor does SCILLC assume any liability arising out of the application or use of any product or circuit, and specifically disclaims any and all liability, including without limitation special, consequential or incidental damages. "Typical" parameters which may be provided in SCILLC data sheets and/or specifications can and do vary in different applications and actual performance may vary over time. All operating parameters, including "Typicals" must be validated for each customer application by customer's technical experts. SCILLC does not convey any license under its patent rights nor the rights of others. SCILLC products are not designed, intended, or authorized for use as components in systems intended for surgical implant into the body, or other applications intended to support or sustain life, or for any other application in which the failure of the SCILLC product could create a situation where personal injury or death may occur. Should Buyer purchase or use SCILLC products for any such unintended or unauthorized application, Buyer shall indemnify and hold SCILLC and its officers, employees, subsidiaries, affiliates, and distributors harmless against all claims, costs, damages, and expenses, and reasonable attorney fees arising out of, directly or indirectly, any claim of personal injury or death associated with such unintended or unauthorized use, even if such claim alleges that SCILLC was negligent regarding the design or manufacture of the part. SCILLC is an Equal Opportunity/Affirmative Action Employer. This literature is subject to all applicable copyright laws and is not for resale in any manner.

PUBLICATION ORDERING INFORMATION

LITERATURE FULFILLMENT:

Literature Distribution Center for ON Semiconductor
P.O. Box 61312, Phoenix, Arizona 85082-1312 USA
Phone: 480-829-7710 or 800-344-3860 Toll Free USA/Canada
Fax: 480-829-7709 or 800-344-3867 Toll Free USA/Canada
Email: orderlit@onsemi.com

N. American Technical Support: 800-282-9855 Toll Free
USA/Canada

Japan: ON Semiconductor, Japan Customer Focus Center
2-9-1 Kamimeguro, Meguro-ku, Tokyo, Japan 153-0051
Phone: 81-3-5773-3850

ON Semiconductor Website: <http://onsemi.com>

Order Literature: <http://www.onsemi.com/litorder>

For additional information, please contact your local Sales Representative.